

MODULAR ELECTRONIC DEVICES



ELKO EP



We are traditional, innovative and purely Czech development manufacturer of electronic devices and we have been your partner in the field of electroinstallations for 26 years.

ELKO EP employs about 330 people, exports its products to more than seventy countries, and has representatives in thirteen foreign branches. Company of the Year of the Zlín Region, Visionary of the Year, Global Exporter of the Year, Participation in the Czech TOP 100, these are just some of the awards received. Still, we are not finished. We are constantly striving to move forward in the field of innovation and development. That's our primary concern.

Millions of relays, thousands of satisfied customers, hundreds of our own employees, twenty six years of research, development and production, thirteen foreign branches, one company. ELKO EP, innovative- a purely Czech company based in Holešov, where development, production, logistics, service and support go hand in hand. We primarily focus on developing and manufacturing systems for building automation in the residential, commercial and industrial sector, a wide range of Smart city facilities and the so-called Internet of Things (IoT).



Facts and stats

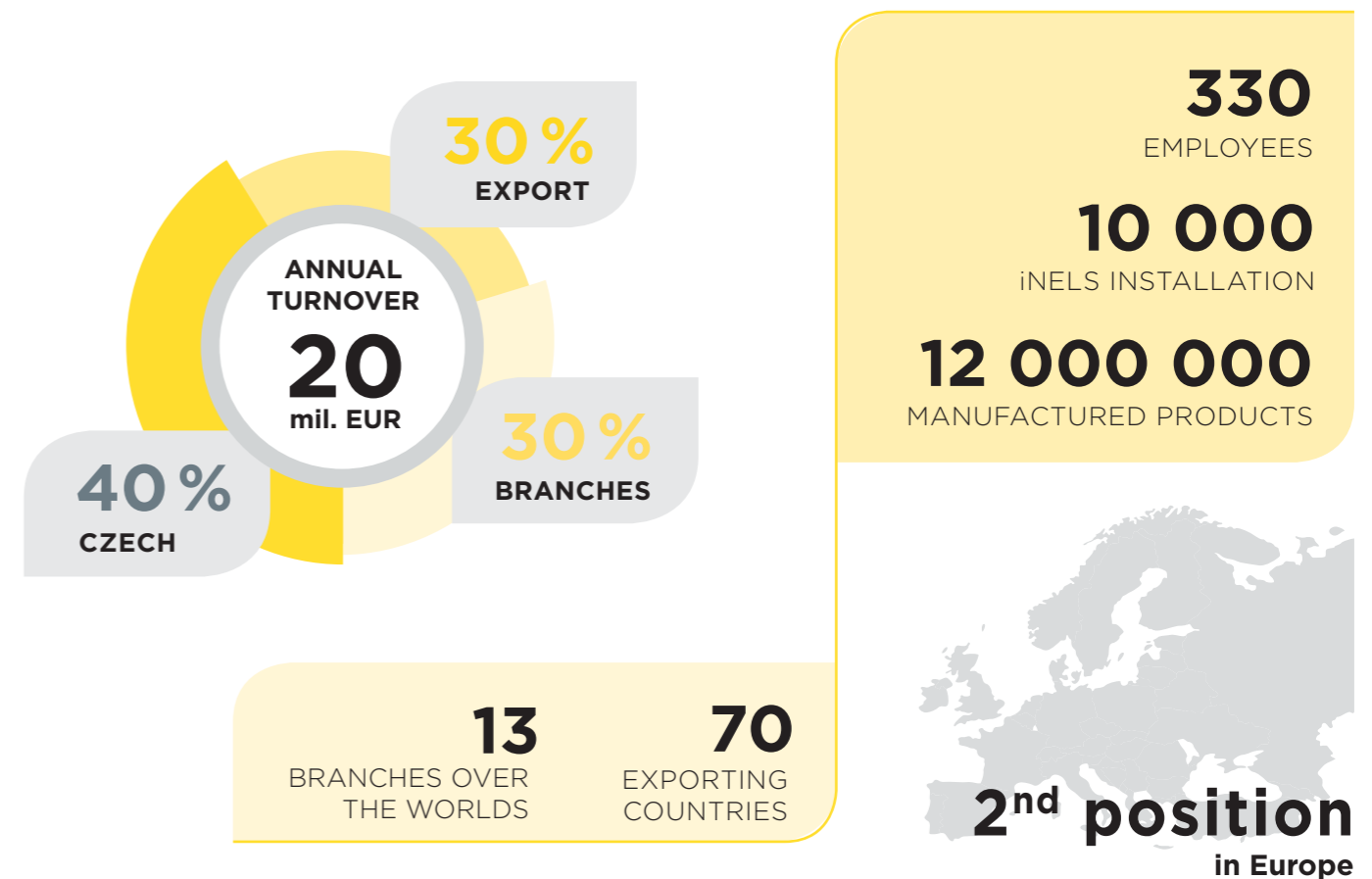

WE ARE



DEVELOPERS

In the new R&D center, more than 30 engineers develop new products and extend the functionality of existing products



PRODUCERS

modern antistatic spaces, 2x fully automated SMD production lines, 2 shift operations.



SUPPORT

24 hours / 7 days / 360 days we not only provide technical support but also logistics.



SELLERS

personal access to more than 70 sales representatives in ELKO EP Holding provides impeccable services and superior products at an affordable price.

Product Lines ELKO EP



Timers/Relays

A wide range of electronic modular devices, which bring new possibilities to home and office control, monitoring and security, as well as to industrial process control: time relays, installation contactors, staircase automatic switches, time switches clocks, dimmers, thermostats, power supplies units, control and signalling devices, GSM gates, etc.

www.elkoep.com/relay-modular-electronic-devices



Protection relays for industry

Every household, every object and every machine needs a monitoring relay. There are several reasons why, overvoltage, under voltage, phase failure, asymmetry, frequency, or power factor.

www.elkoep.com/protection-monitor-relay



iNELS Air - IoT devices

The new iNELS Air product line responds to the dynamically developing network IoT (Internet of Things). These networks enable devices to communicate safely, over long distances and are optimized to minimize power consumption. The product group includes sensors for communication on the Sigfox, LoRa and NB-IoT protocol.

www.elkoep.com/iot-products



Wireless electroinstallation (RF)

A unique wireless control system providing you perfect control over your home! The RF Control system enables you to control functions such as heating, lighting, electrical appliances and window shutters, all with a single touch. No wall cutting, fast and easy installation, exclusive design of wireless wall switch buttons and other components.

www.elkoep.com/wireless-rf-control



Wired electroinstallation (BUS)

The BUS system offers a unique solution for new installations (refurbishment) in family houses, hotels and villas. It offers a wide range of functions for both automation and comfort.

www.elkoep.com/inels-bus-system



Energy management

Measuring energy consumption in the home or in larger areas is an increasing trend. Our products provide measurement with three different technologies - using a BUS or wireless system and thanks also with the IoT.

www.elkoep.com/energy-management



Wireless Retrofit Hotel (HRESK)

Hotel Room Energy Saving Kit - Solutions for hotel rooms based on wireless technology is designed to function in existing hotels. It is possible to simply elevate the existing electrical installation to a higher level without long-lasting construction modifications.

www.elkoep.com/hotel-hresk



Hospitality Hotel (GRMS)

Guest Room Management System - The BUS system is designed mainly for hotels and offers comfortable and easy control of hotel rooms, reception and restaurant.

www.elkoep.com/inels-hospitality



Building management system

Building Management System is a comprehensive solution for monitoring, and controlling even the most complex of building systems. You can monitor everything on your computer monitor or tablet in the comfort of reception or office.

www.elkoep.com/bms



Lighting control

A sector that offers complete control over all lighting devices. From switching, dimming to controlling your favourite DALI luminaires. Everything can be controlled with a connection to iNELS wired or wireless technology.

www.elkoep.com/lighting-control



Multimedia

Here you can find extensions for our iNELS system and not just for it. Lara Music Players, Intercoms and Door Communicators, Application Communication Servers and 3rd party applications.

www.elkoep.com/av-multimedia



Switches and sockets

We offer you exclusive switches, sockets and accessories in a standard plastic or metallic design. However, there are also charming luxury frames from purely natural materials such as genuine wood, metal, granite or hardened glass. Be especial!

www.elkoep.com/logus90-products



Lighting sources

Are you looking for a bulb in your chandelier? In this section you will find among the most common types of bulbs also LED strips and other LED sources, power transformers and installation accessories such as ALU profiles, diffusers.

www.elkoep.com/lighting-sources

CRM-100



The brand new CRM-100 **digital multi-function time relay** is used, for example, to control lighting in your home, but it can also be used to control motors or pumps. Thanks to the digital setting and display time, the need for mechanical adjustment of the devices is avoided, resulting in maximum accuracy. This versatile power relay includes the 17 most used functions for each application. If you have it at your fingertips, it will replace many other types which you needn't look for or buy.

SHT-7

Near Field Communication is the way of wireless communication of two devices within a short distance of a few centimeters. A typical example of NFC is credit card payment, but now our ability to control your timing clock is also an option. You can also conveniently set it up using a smartphone and transfer these set modes to other devices, clone them or back them up.



NEW



Protection relays for industry

New types feature the ability to measure with accuracy of approximately 2%, which distinguishes them from cheap competitors and increases reliability. The relay boasts a lower power output of only 2.5 watts and the ability to monitor both alternating voltage and non-sinusoidal waveforms. They are suitable for 50 Hz and 60 Hz, which is especially appreciated by customers, whose products travels overseas. Thanks to the AT Mega 48P processor we can customize the parameters of the product. Inside the product there are no plug connections, so they are mechanically very resistant to shocks as well.

Time relays	
CRM-81J, CRM-83J Single-function time relay	10
CRM-82TO Delay OFF without supply voltage	11
SJR-2 Doublestage delay unit	12
CRM-2T Delay ON star/delta	13
CRM-2H Asymmetric cycler	14
CRM-61 Multifunction time relays	15
CRM-91H, CRM-93H, CRM-95 Multifunction time relays	16
CRM-100 Digital multifunction time relay - NEW	18
CRM-91HE, CRM-2HE Time relay with external potentiometer	20
PRM-91H/8, PRM-91H/11, PRM-92H, PRM-2H Plug-in time relay	21
PDR-2/A, PDR-2/B Programmable digital relay	22
SHT-1, SHT-1/2, SHT-3, SHT-3/2 Digital time switch clock	24
SHT-4 Digital time switch with an astronomical program	25
SHT-6 Time switch with DCF control	26
DCFR-1 Receiver DCF 77	27
SHT-7 Switch timer clock with NFC programming capability - NEW	28
SMR-K, SMR-T, SMR-H, SMR-B Super-multifunction relay	30
CRM-42, CRM-42F Programmable staircase switch with signalling before switch off	32
CRM-4 Staircase switch	34
Auxiliary and Power relays	
VS116B/230, VS116K, VS116U, VS308K, VS308U, VS316/24, VS316/230 Power relays	36
750L, 782L Power relays plug-in	38
Dimmers	
DIM-2 Staircase switch with dimming	42
DIM-5 Controlled dimmer	43
DIM-6 Controlled dimmer	44
DIM6-3M-P Expanding power module	45
DIM-15, SMR-M Universal dimmer	46
DIM-14 Controlled dimmer	48
SMR-S, SMR-U Controlled dimmer	49
LIC-1 Lighting intensity controller	50
LIC-2 Lighting intensity controller	51
Power supplies	
PSB-10-12, PSB-10-24, PS-10-12, PS-10-24, PS-30-12, PS-30-24, PS-30-R, PS-100-12, PS-100-24 Power supplies	54
DR-60-12, DR-60-24 Power supplies	56
ZSR-30, ZNP-10 Power supply	57
ZTR-8-8, ZTR-8-12, ZTR-15-12 Bell transformers	58
Twilight switches	
SOU-1 Twilight switch	61
SOU-2 Twilight switch with digital time switch clock	62
SOU-3 Twilight light switch	63
Memory relays	
MR-41, MR-42 Memory & latching relays	64
Control and signalling devices	
USS Controlling and signalling modules	65
Monitoring relays	
HRN-33, HRN-63 HRN-34, HRN-64, HRN-35, HRN-37, HRN-67 Monitoring voltage relay	70
HRN-41, HRN-42 Monitoring voltage relay	72
HRN-43, HRN-43N Relay for complete monitoring 3-phase mains	74
HRN-54, HRN-54N Relay for monitoring over/under voltage, phase sequence and failure	76
HRN-55, HRN-55N Relay for monitoring phase sequence and failure	77
HRN-56 Relay for monitoring phase sequence and failure	78
HRN-57, HRN-57N Relay for monitoring over/under voltage in 3-phase mains	79
MPS-1 Optical signaling of three-phase main	80
HRF-10 Frequency monitoring relay	81
COS-2 Power factor monitoring relay - INNOVATION	82

PRI-32 Current monitoring relay	84
PRI-51 Current monitoring relay	85
PRI-41, PRI-42 Current monitoring relay	86
PRI-52 Current monitoring relay	88
PRI-53 Three-phase current monitoring relay	89
HRH-5 Level switch	90
HRH-4 Level set	91
HRH-6 Level switch	92
HRH-7 Level switch	94
HRH-8 Level switch - INNOVATION	96
HRH-x Level sets	98
Level switches accessories	
SHR Level sensors	100
Cables, wires	101
Thermostats and hygrostats	
TER-3A, TER-3B, TER-3C, TER-3D, TER-3G, TER-3H Thermostats	104
TER-3E, TER-3F Thermostats	105
TER-4 2-stage thermostat	106
TER-9 Multifunction digital thermostat	108
TER-7 Thermostat for monitoring temperature of motor winding	110
ATR, ATF, ATC Analog room and floor thermostat	111
DTR, DTF, DTC Digital room and floor thermostat	112
ATV-1 Energy-saving digital thermo-valve	113
TEV-1 Thermostat	114
TEV-2, TEV-3 Thermostats	115
TEV-4 Thermostat	116
RHT-1 Hygro-thermostat	117
RHV-1 Hygrostat	118
Accessories to Thermostats	
TC, TZ, Pt100 Temperature sensors	119
Telva 230 V, Telva 24V Thermo drive	120
Protection relays for industry - NEW	
VROU1-28 Under and over voltage monitoring relays	125
VRU1-28, VRO1-28 Voltage monitoring relays	126
VRSC1-28 Synchro-check monitoring relays	128
VRMV1-28 DC low voltage monitoring relays	129
VROU3-28 Under and over voltage monitoring relays	130
VRU3-28 Under voltage monitoring relays	131
VRO3-28 Over voltage monitoring relays	132
VROU3N-28 Under and over voltage monitoring relays	133
VRU3N-28 Under voltage monitoring relays	134
VRO3N-28 Over voltage monitoring relays	135
VRSF3, VRSF3N Failure and phase sequence monitoring relays	136
VRBU3, VRBU3N Phase balance and undervoltage monitoring relays	138
CROU1-28 Under and over AC current monitoring relays	140
CRU1-18, CRO1-18 AC current monitoring relays	141
CRGF1-18 Ground fault monitoring relays	142
CRMA1-28 DC low current monitoring relays	144
CRRP1-28, CRRP3-28 Reverse power monitoring relays	146
FRSS1-38 Speed sensing/monitoring relay	148
Installation contactors	
VS120, VS220, VS420, VS425, VS440, VS463 Installation contactors	150
VSM220, VSM425 Installation contactors with manual control	152
Technical information	155

TIME RELAYS

Single-function

CRM-81J
3 functions and 6 time ranges, multivoltage or 230 V supply, output 16 A changeover/SPDT.

CRM-83J
as CRM-81J but with 3x8 A changeover output/SPDT.

CRM-82TO
"true OFF" relay - delay off without supply, for back-up circuits.

SJR-2
two-state delay unit (2x delay on), gradual switching of high loads.

CRM-2T
delay start-up of motors star/delta.

CRM-2H
asymmetric cyclers, independent time setting ON/OFF.

CRM-2HE
as CRM-2H, but time setting by external potentiometers (for frequent setting).

Multifunction

Analog

CRM-91H
10 functions, 10 time ranges, 1x output 16 A changeover/SPDT, multivoltage or 230 V supply.

CRM-93H
as CRM-91H but with 3x 8 A changeover/SPDT.

CRM-9S
as CRM-91H but with contactless output (triac 0.7A).

CRM-61
cost effective version of CRM-91H, 6 functions, 6 time ranges. Output 8 A changeover/SPDT, supply AC 24-240 V, DC 24V.

CRM-91HE
as CRM-91H but with time setting by external potentiometer (for frequent setting).

Potentiometer
potentiometer - external control unit for CRM-91HE and CRM-2HE, mounting into a switchboard, max connection length 10 m.

Digital

CRM-100 NEW
17 functions, time range 0.1 s - 999 hours, 1x 8 A changeover contact, power supply 24-240 V AC/DC.

PDR-2A
4 digit display, 16 functions, 2 independent times 0.01s-100 hrs, 2 outputs 16 A changeover/SPDT START/STOP inputs.

PDR-2B
as PDR-2A but 10 functions for each output and time - meaning two relays in one device.

SHT-1, SHT-1/2
SHT-1: time switch with daily, weekly, monthly, and annual programming. 1-channel, output 16 A changeover/SPDT. SHT-1/2: as SHT-1, but 2-channel.

SHT-3, SHT-3/2
as SHT-1 but with daily, weekly, monthly, and annual programming up to 2095. SHT-3/2: as SHT-3, but 2-channel.

SHT-4
Timer with an astronomical program to control the lighting without using a light sensor. 2-channel.

SHT-6
Time switch with DCF managing. Daily, weekly and annual program, output 16 A. 1-channel.

SHT-7 NEW
Switch Timer clock with day and year program. Setting up with a smartphone supporting NFC transfer

PLUG-IN

PRM-91H/11
as CRM-91H but into 11-pin socket, multivoltage supply, output contact 16 A.

PRM-91H/8
as PRM-91H/11 but with 8-pin socket, output contact 16 A.

PRM-92H
as PRM-91H but with 2x changeover / SPDT 8 A contacts, into 11-pin socket.

PRM-2H
as CRM-2H but with 11-pin socket, 2x changeover, 8 A contact.

socket to DIN rail
ES-11 (11 pin) ES-8 (8 pin).

MINI

SMR-K
super multifunction relay for installation into an installation box, 3 wire connection (without neutral). Input can be connected in parallel with LED energy saving light bulb or fluorescent lamp.

SMR-T
super multifunction relay for installation into a wiring box, 3 wire connection (without neutral).

SMR-H
as SMR-T but 4 wire connection, output - triac 0-200 VA, 9 functions including function of memory relay.

SMR-B
as SMR-H but output relay contact 16 A (possibility to switch also fluorescent lights).

Staircase switch

CRM-4
basic version, time 0.5-10 min, output contact 16 A, anti-blocking function.

CRM-42
programmable staircase switch with warning before switching off, time setting by number of button pressings.

CRM-42F
programmable staircase switch without warning before switching off, time setting by number of button pressings.

DIM-2
with dimming, setting: dim-up/shining/dim-down brightness only for el. bulbs output up to 500 VA.

Time relay review

Chart 1. Version
DIN rail mounting

Type	Type																	
	CRM-81J/ZR	CRM-81J/ZN	CRM-81J/BL	CRM-83J/ZR	CRM-83J/ZN	CRM-83J/BL	CRM-82TO	CRM-91H	CRM-93H	CRM-91HE	CRM-2HE	CRM-9S	CRM-2H	CRM-2T	CRM-4	CRM-42 (CRM-42F)		
Design	1-MODULE	•	•	•	•	•	•	•	•	•	•	•	•	•	•	•	•	
	2-MODULE																	
	3-MODULE																	
	PLUG-IN																	
Adjusting	Under the switch	See chart 2 Version - mounting into an installation box																
	Rotary switch	•	•	•	•	•	•	•	•	•	•	•	•	•	•	•	•	
	Button																	
Functions	Delay OFF after switch off the Input supply																	
	Delay ON	•			•		•	•	•	•								
	Delay OFF	•			•		•	•	•	•								
	Symmetrical cyclers starting with delay							•	•	•								
Time	Delay OFF after impulse OFF				•		•	•	•									
	Symmetrical cyclers starting with impulse							•	•	•								
	Staircase switch							•	•	•								
	Impulse shift							•	•	•								
	Memory (impulse) relay							•	•	•								
	Impulse generator							•	•	•								
	Delay ON at switch on controlling contact																	
	Asymmetric cyclers starting with delay																	
	Asymmetric cyclers starting with impulse																	
	Delay ON star / delta																	
Supply voltage	Switching in real time																	
	Impuls relay in delay ON																	
	0.1 - 1 s	•	•	•	•	•	•	•	•	•	•	•	•	•	•	•	•	
	1 - 10 s	•	•	•	•	•	•	•	•	•	•	•	•	•	•	•	•	
	0.1 - 1 min	•	•	•	•	•	•	•	•	•	•	•	•	•	•	•	•	
	1 - 10 min	•	•	•	•	•	•	•	•	•	•	•	•	•	•	•	•	
	0.1 - 1 hrs	•	•	•	•	•	•	•	•	•	•	•	•	•	•	•	•	
	1 - 10 hrs	•	•	•	•	•	•	•	•	•	•	•	•	•	•	•	•	
	0.1 - 1 day																	
	1 - 10 days																	
Output	3 - 30 days																	
	10 - 100 days																	
	30 s - 10 min																	
	99 h 59 min 59 s																	
	Day																	
	Week																	
	Month																	
	Year																	
	230 V AC	•	•	•	•	•	•	•	•	•	•	•	•	•	•	•	•	•
	12 - 240 V AC/DC	•	•	•	•	•	•	•	•	•	•	•	•	•	•	•	•	•
Output	12 - 240 V AC																	
	1x changeover / SPDT 8 A																	
	1x changeover / SPDT 16 A	•	•	•														
	2x changeover / DPDT 8 A																	
	2x changeover / DPDT 16 A																	
	3x changeover / SPDT 8 A																	
Static output (triac)																		
1x NO 16 A																		

Chart 2. Version
Mounting into an installation box

Type	Type		
	SMR-K, SMR-T, SMR-H	SMR-B	
Functions	a - delay off on entering edge	•	•
	b - delay off on downward edge	•	•
	c - delay off on downward edge	•	•
	d - cyclers - flasher by impuls	•	•
	e - pulse shift	•	•
	f - delay on	•	•
	g - pulse relay	•	•
	h - impulse relay with delay	•	•
	i - cyclers starting with gap	•	•
	j - delay on after switched off		•
Time	0.1 - 1 s	•	•
	1 - 10 s	•	•
	0.1 - 1 min	•	•
	1 - 10 min	•	•
	0.1 - 1 h	•	•
Supply voltage	1 - 10 h	•	•
	0.1 - 1 day	•	•
	1 - 10 days	•	•
Number of contacts	AC 230 V	•	•
	1x triac	•	
	1x NO AgSnO ₂		•



EAN code CRM-81J according to type CRM-83J according to type

Technical parameters table for CRM-81J and CRM-83J. Includes sections for Functions, Supply terminals, Voltage range, Burden, Consumption, Max. dissipated power, Supply voltage tolerance, Supply indication, Time ranges, Time setting, Time deviation, Repeat accuracy, Temperature coefficient, Output, Control, and Other information.

- Single-function and single-time relay with fine time setting by a potentiometer (within the frames of a particular time range).
• Suitable for applications where function and time requirements are known.
• Time switch, possible to be used for pump delay after switching heating off, switching of fans.
• Choice of 3 functions: 1) ZR - Delay ON, 2) ZN -Delay OFF, 3) BL - Repeat Cycle
• Functions can be controlled by supply voltage or time scale control input
• Choice of 6 time ranges: (0.1 s - 1 s / 1 s - 10 s / 6 s - 60 s / 1 min - 10 min / 6 min - 60 min / 1 h - 10 hrs)
• Universal voltage range AC/DC 12 - 240 V or AC 230 V.
• Output contact: CRM-81J: 1x changeover/ SPDT 16 A CRM-83J: 3x changeover/ 3PDT 8 A.
• Red LED output indicator.
• 1-MODULE, DIN rail mounting.

Description

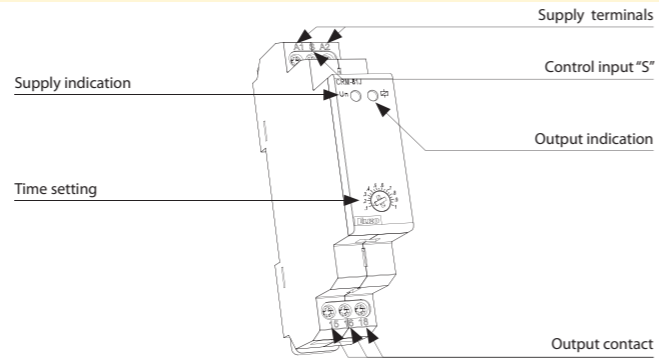

Functions

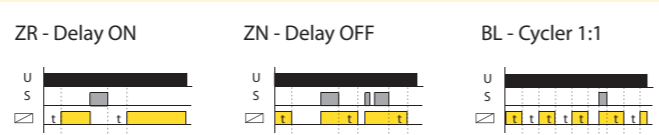

Note: the function ZR and ZN is controlled by supply voltage and control input ie. Once phase failure is detected and supply voltage is re applied, The relay automatically makes one cycle.

Connection

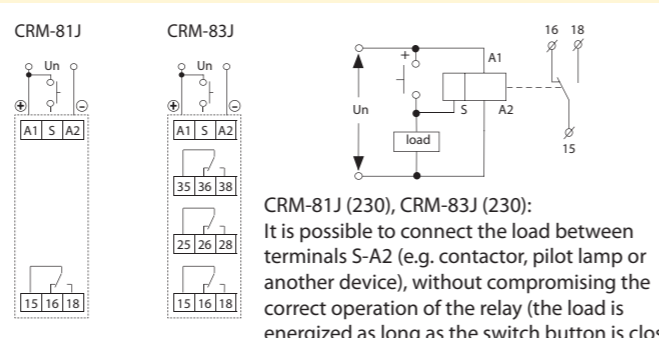

Symbol

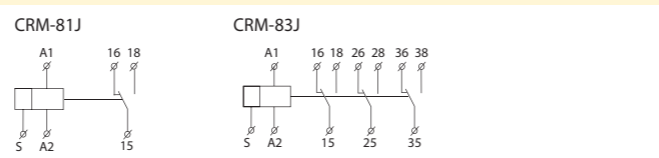

Example of an order

CRM-81J/230, ZR10s: 1x changeover contact, voltage AC 230 V, function: delay ON, time 1 - 10 s
CRM-83J/UNI, BL1h: 3x changeover contact, voltage AC/DC 12-240 V, function: cycler begin with impulse, time 6-60 min



EAN code CRM-82TO /UNI: 8595188137614

Technical parameters table for CRM-82TO. Includes sections for Number of functions, Supply terminals, Voltage range, Burden, Max. dissipated power, Supply voltage tolerance, Supply indication, Time ranges, Time setting, Time deviation, Repeat accuracy, Temperature coefficient, Output, Other information, and Standards.

- „True OFF“ relay - relay timing without supply voltage.
• Example of use: back-up source for Delay OFF in case of voltage failure (e.g. emergency lighting, emergency respirator, or protection of el. controlled doors - in case of fire).
• 2 time functions adjustable by rotary switch: a - Delayed return after disconnecting of supply, e - Delayed start.
• Time range (adjustable by rotary switch and fine setting by potentiometer): 0.1 s - 10 min.
• Universal supply voltage AC/DC 12 - 240 V.
• Interruptions in the power supply must take time steps (tens to hundreds of milliseconds).
• Output contact: 2x changeover / DPDT 8 A.
• Output status indicated by red LED (only in case of supply voltage connection).
• Clamp terminals.
• 1-MODULE, DIN rail mounting.

Description

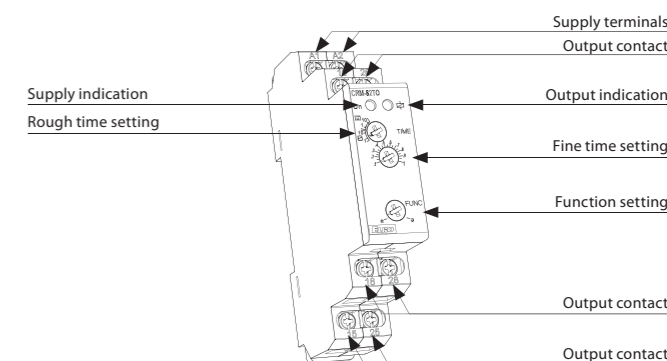

Function

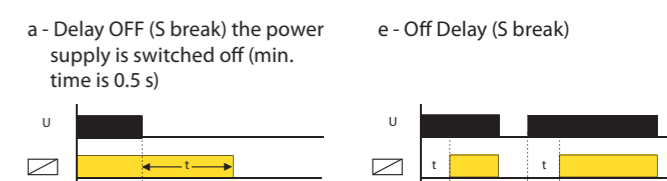

Connection

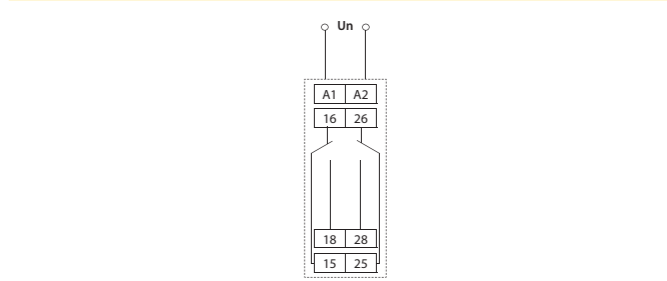

Symbol

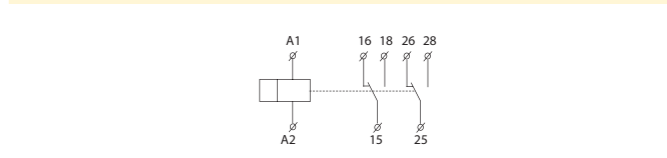

SJR-2 | Doublestage delay unit



- For gradual switching of high power (e.g. el.heating), prevents current strokes in the main.
- Function: 2x Delay ON (2 time relays in one).
- Time scale 0.1s - 10 days divided into 10 time ranges: 0.1s - 1s / 1s - 10s / 0.1min - 1min / 1min - 10min / 0.1h - 1h / 1h - 10hrs / 0.1 day - 1 day / 1 day - 10 days / ON / OFF
- Times t1 and t2 are independantly adjustable.
- t1 and t2 are switched on after supply voltage connection.
- Rough time setting via rotary switch.
- Voltage range: AC 230 V or AC/DC 12 - 240 V.
- Output contact: 2 x changeover / DPDT 16 A.
- Output indication: multifunction red LED, flashing at certain states.
- 1-MODULE, DIN rail mounting.

EAN code
SJR-2 /230 V: 8595188116015
SJR-2 /UNI: 8595188117401

Technical parameters		SJR-2
Number of functions:		2x delay ON
Supply terminals:		A1 - A2
Voltage range:	UNI	AC/DC 12 - 240 V (AC 50 - 60 Hz)
Burden (max.):	UNI	AC 0.7 - 3 VA / DC 0.5 - 1.7 W
Voltage range:	230	AC 230 V / 50 - 60 Hz
Power input (apparent/loss):	230	AC max. 12 VA / 1.3 W
Max. dissipated power (Un + terminals):		4.5 W
Supply voltage tolerance:		-15 %; +10 %
Supply indication:		green LED
Time ranges:		0.1 s - 10 days
Time setting:		rotaty switch and potentiometer
Time deviation:		5 % - mechanical setting
Repeat accuracy:		0.2 % - set value stability
Temperature coefficient:		0.01 % / °C, at = 20 °C (0.01 % / °F, at = 68 °F)
Output		
Number of contacts:		2x changeover/ DPDT (AgNi / Silver Alloy)
Current rating:		16 A / AC1
Breaking capacity:		4000 VA / AC1, 384 W / DC
Inrush current:		30 A / < 3 s
Switching voltage:		250 V AC1 / 24 V DC
Output indication:		multifunction red LED
Mechanical life:		3x10 ⁷
Electrical life (AC1):		0.7x10 ⁵
Reset time:		max. 150 ms
Other information		
Operating temperature:		-20 °C to 55 °C (-4 °F to 131 °F)
Storage temperature:		-30 °C to 70 °C (-22 °F to 158 °F)
Electrical strength:		4 kV (supply-output)
Operating position:		any
Mounting:		DIN rail EN 60715
Protection degree:		IP40 from front panel / IP20 terminals
Overvoltage category:		III.
Pollution degree:		2
Max. cable size (mm ²):		solid wire max. 1x 2.5 or 2x1.5/ with sleeve max. 1x 2.5 (AWG 12)
Dimensions:		90 x 17.6 x 64 mm (3.5" x 0.7" x 2.5")
Weight:		UNI - 85 g (3 oz.), 230 - 83 g (2.9 oz.)
Standards:		EN 61812-1, EN 61010-1

Description

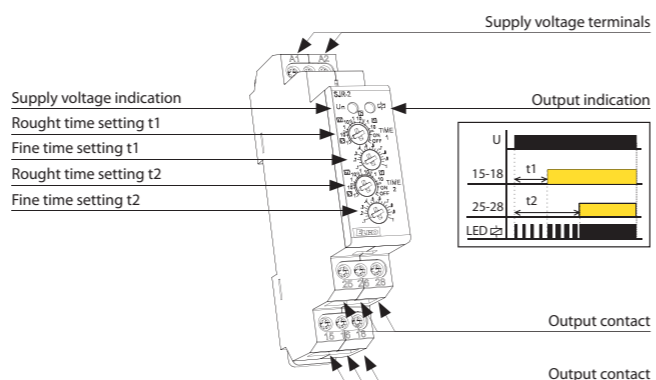

Function

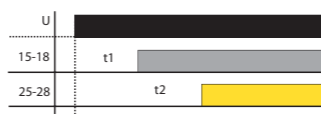

Connection



Symbol

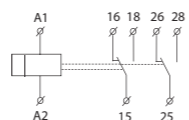

CRM-2T | Delay ON star / delta



- It serves for delay ON of motors star/delta.
- Time t1 (star)
 - time scale 0.1 s - 100 days divided into 10 time ranges.
 - rough time setting by rotary switch
- Time t2 (delay) between Δ / Δ :
 - time scale 0.1 s - 1 s
 - fine time setting by potentiometer
- Voltage range: AC 230 V, AC/DC 12 - 240 V.
- Output contact: 2x changeover / DPDT 16 A.
- Output indication: multifunction red LED.
- 1-MODULE, DIN rail mounting.

EAN code
CRM-2T /230 V: 8595188112291
CRM-2T /UNI: 8595188112437

Technical parameters		CRM-2T
Number of functions:		1
Supply terminals:		A1 - A2
Voltage range:	UNI	AC/DC 12 - 240 V / AC 50 - 60 Hz
Burden (max.):	UNI	AC 0.7 - 3 VA / DC 0.5 - 1.7 W
Voltage range:	230	AC 230 V / 50 - 60 Hz
Burden:	230	AC max. 12 VA / 1.9 W
Max. dissipated power (Un + terminals):		4 W
Supply voltage tolerance:		-15 %; +10 %
Supply indication:		green LED
Time scale:		t1: 0.1 s - 100 days, t2: 0.1 s-1 s
Time setting:		potentiometer
Time deviation:		5% - mechanical setting
Repeat accuracy:		0.2 % - set value stability
Temperature coefficient:		0.01 % / °C, at = 20 °C (0.01 % / °F, at = 68 °F)
Output		
Number of contacts:		2x changeover/ DPDT (AgNi / Silver Alloy)
Current rating:		16 A / AC1
Breaking capacity:		4000 VA / AC1, 384 W / DC
Inrush current:		30 A / < 3 s
Switching voltage:		250 V AC1 / 24 V DC
Output indication:		multifunction red LED
Mechanical life:		3x10 ⁷
Electrical life (resistive):		0.7x10 ⁵
Reset time:		max. 150 ms
Other information		
Operating temperature:		-20 °C to 55 °C (-4 °F to 131 °F)
Storage temperature:		-30 °C to 70 °C (-22 °F to 158 °F)
Electrical strength:		4 kV (supply-output)
Operating position:		any
Mounting:		DIN rail EN 60715
Protection degree:		IP40 from front panel / IP20 terminals
Overvoltage category:		III.
Pollution degree:		2
Terminal wire capacity (mm ²):		max.1x 2.5, 2x1.5, with sleeve max. 1x 2.5 (AWG 12)
Dimensions:		90 x 17.6 x 64 mm (3.5" x 0.7" x 2.5")
Weight:		UNI - 84 g (3 oz.), 230 - 81 g (2.9 oz.)
Standards:		EN 61812-1, EN 61010-1

Description

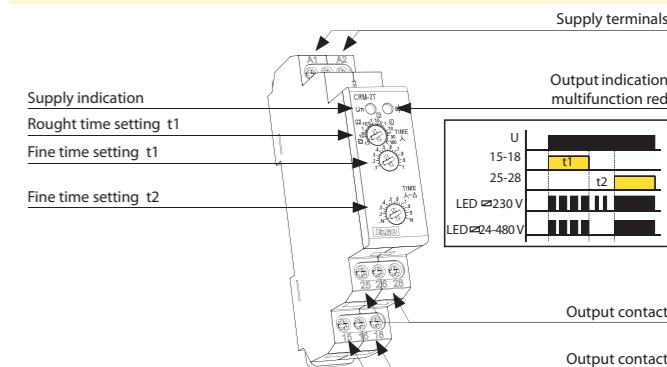

Function

Delay ON star / delta

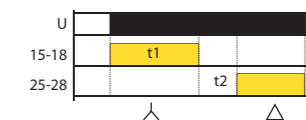

Connection

Start up of motor (Δ - Δ)

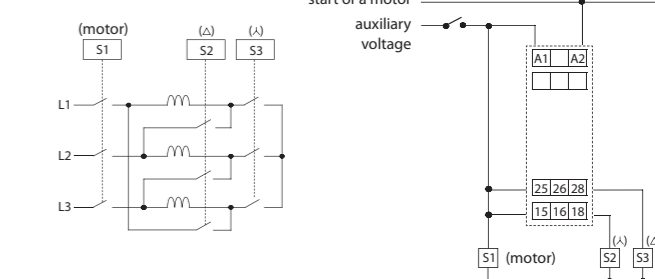

Symbol

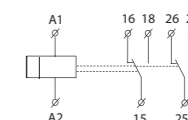



EAN code
CRM-2H / 230 V: 8595188124201
CRM-2H / UNI: 8595188113007

Technical parameters		CRM-2H
Number of functions:		2 (function is chosen by connecting S-A1)
Supply terminals:		A1 - A2
Voltage range:	UNI	AC/DC 12 - 240 V (AC 50 - 60 Hz)
Burden (max.):		AC 0.7 - 3 VA / DC 0.5 - 1.7 W
Voltage range:	230	AC 230 V / 50 - 60 Hz
Power input (apparent/loss input):		AC max. 12 VA / 1.3 W
Max. dissipated power (Un + terminals):		4 W
Supply voltage tolerance:		-15 %; +10 %
Supply indication:		green LED
Time scale:		0.1 s - 100 days
Time setting:		rotary switch and potentiometer
Time deviation:		5 % - mechanical setting
Repeat accuracy:		0.2 % - set value stability
Temperature coefficient:		0.01 % / °C, at = 20°C (0.01 % / °F, at = 68°F)
Output		
Number of contacts:		1x changeover/ SPDT (AgNi / Silver Alloy)
Current rating:		16 A / AC1
Breaking capacity:		4000 VA / AC1, 384 W / DC
Inrush current:		30 A / < 3 s
Switching voltage:		250 V AC1 / 24 V DC
Output indication:		multifunction red LED
Mechanical life:		3x10 ⁷
Electrical life (resistive):		0.7x10 ⁵
Reset time:		max. 150 ms
Other information		
Operating temperature:		-20 °C to 55 °C (-4 °F to 131 °F)
Storage temperature:		-30 °C to 70 °C (-22 °F to 158 °F)
Electrical strength:		4 kV (supply-output)
Operating position:		any
Mounting:		DIN rail EN 60715
Protection degree:		IP40 from front panel / IP20 terminals
Overvoltage category:		III.
Pollution degree:		2
Terminal wire capacity (mm ²):		solid wire max. 1x 2.5 or 2x 1.5 / with sleeve max. 1x 2.5 (AWG 12)
Dimensions:		90 x 17.6 x 64 mm (3.5" x 0.7" x 2.5")
Weight		UNI - 63 g (2.2 oz.), 230 - 61 g (2.2 oz.)
Standards:		EN 61812-1, EN 61010-1

- Cycler with independent adjustable switch ON/OFF
- Used for regular room ventilation, cyclic dehumidification, light control, circulating pumps, illuminated advertising, etc.
- 2 time functions:
 - 1) Cycler beginning with pulse
 - 2) Cycler beginning with pause
- Function choice is done by an external jumper of terminals S-A1
- Time scale 0.1 s - 100 days divided into 10 time ranges: (0.1 s - 1 s / 1 s - 10 s / 0.1 min - 1 min / 1 min - 10 min / 0.1 hrs - 1 h / 1 h - 10 hrs / 0.1 day - 1 day / 1 day - 10 days / 3 days - 30 days / 10 days - 100 days)
- Rough time setting via rotary switch
- Voltage range: AC 230 V or AC/DC 12 - 240 V
- Output contact: 1x changeover / SPDT 16 A
- Output indication: multifunction red LED
- 1-MODULE, DIN rail mounting

Description

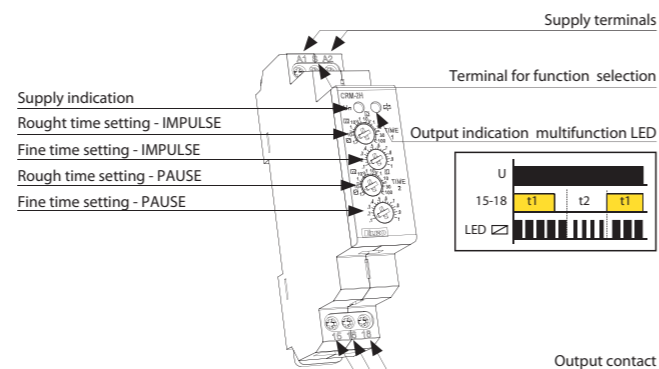

Function

Cycler beginning with pulse

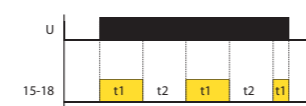

Cycler beginning with pause

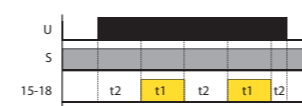

Connection

Cycler beginning with pulse

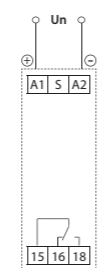

Cycler beginning with pause (jumper S-A1)

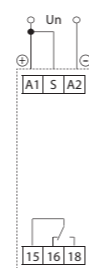

Symbol

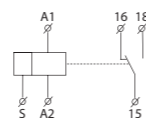

EAN code
CRM-61: 8595188120210

Technical parameters		CRM-61
Number of functions:		6
Supply terminals:		A1 - A2
Supply voltage :		AC 24 - 240 V (AC 50 - 60 Hz) and DC 24 V
Burden (max.):		AC 0.7 - 3 VA / DC 0.5 - 1.7 W
Max. dissipated power (Un + terminals):		3 W
Supply voltage tolerance:		15 %; +10 %
Supply indication:		green LED
Time ranges:		0.1 s - 10 h
Time setting:		rotary switch and potentiometer
Time deviation:		5 % - mechanical setting
Repeat accuracy:		0.2 % - set value stability
Temperature coefficient:		0.01 % / °C, at = 20°C (0.01 % / °F, at = 68°F)
Output		
Number of contacts:		1x changeover/ SPDT (AgNi / Silver Alloy)
Current rating:		8 A / AC1
Breaking capacity:		2000 VA / AC1, 240 W / DC
Output indication:		multifunction red LED
Mechanical life:		1x10 ⁷
Electrical life (AC1):		1x10 ⁵
Controlling		
Control. voltage:		AC 24 - 240 V (AC 50 - 60 Hz) and DC 24 V
Control power input:		AC 0.025 - 0.2 VA / DC 0.1 - 0.7 W
Load between S-A2:		Yes
Glow-tubes:		No
Control. terminals:		A1-S
Max. capacity of cable control:		0.1 µF
Impulse length:		min. 25 ms / max. unlimited
Reset time:		max. 120 ms
Other information		
Operating temperature:		-20 °C to +55 °C (-4 °F to 131 °F)
Storage temperature:		-30 °C to +70 °C (-22 °F to 158 °F)
Electrical strength:		4 kV (supply-output)
Operating position:		any
Mounting:		DIN rail EN 60715
Protection degree:		IP40 from front panel / IP10 terminals
Overvoltage category:		III.
Pollution degree:		2
Max. cable size (mm ²):		max. 2x 2.5, max. 1x 4 with sleeve max. 1x 2.5, 2x 1.5 mm ² (AWG 12)
Dimensions:		90 x 17.6 x 64 mm (3.5" x 0.7" x 2.5")
Weight:		68 g (2.4 oz.)
Standards:		EN 61812-1, EN 61010-1

- Multifunction time relay (6 functions and 6 time ranges), economic version of CRM-91H
- To be used for electrical appliances, control of lights, heating, motors, pumps, fans, etc.
- 6 functions:
 - 3 time functions controlled by supply voltage
 - 3 time functions controlled by control input
- Easy to use function and time-range setting by rotary switches
- Time scale 0.1 s - 10 hrs divided into 6 range: (0.1 s - 1 s / 1 s - 10 s / 0.1 min - 1 min / 1 min - 10 min / 0.1 hrs - 1 h / 1 h - 10 hrs)
- Universal voltage range: AC 24 - 240 V, DC 24 V
- Output contact: 1x changeover 8 A / SPDT
- Multifunction red LED output indicator flashes or shines depending on the status of output
- 1-MODULE, DIN rail mounting

Description

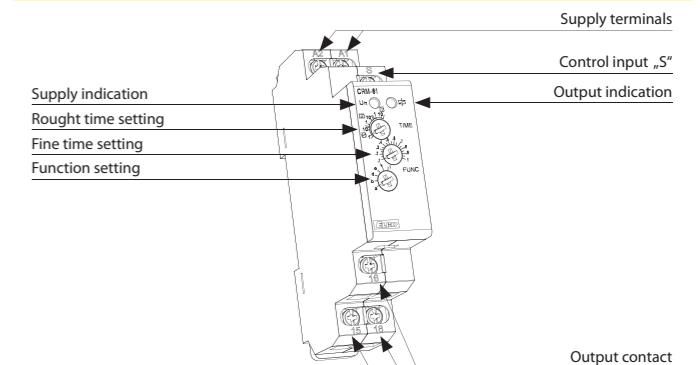

Function

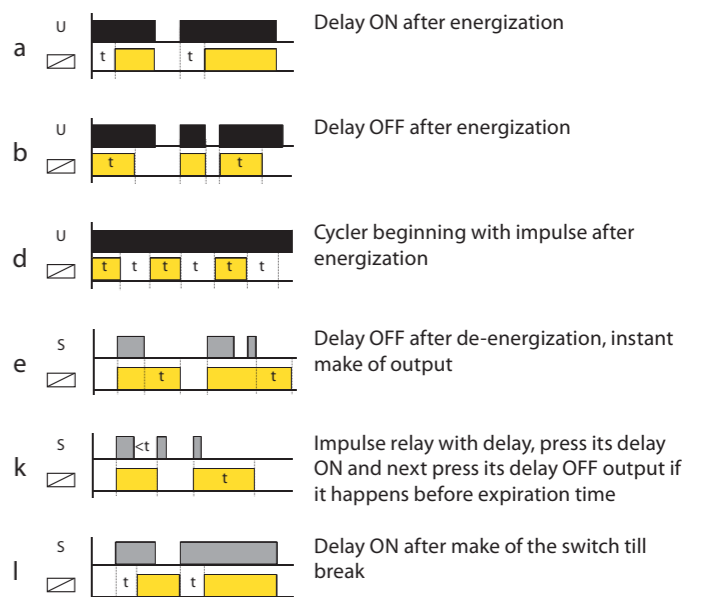

Connection

Symbol

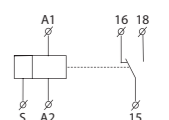
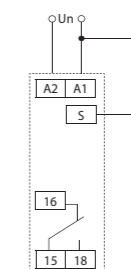



EAN code
CRM-91 /230 V: 8595188112444
CRM-91 /UNI: 8595188112420
CRM-93H /230 V: 8595188112789
CRM-93H /UNI: 8595188112468
CRM-9S /UNI: 8595188116008

Technical parameters table for CRM-91H, CRM-93H, CRM-9S. Columns include Number of functions, Supply terminals, Voltage range, Burden (max.), Consumption, Max. dissipated power, Supply voltage tolerance, Supply indication, Time ranges, Time setting, Time deviation, Repeat accuracy, Temperature coefficient, Output, Number of contacts, Current rating, Breaking capacity, Inrush current, Switching voltage, Voltage drop on switch, Load on B1 terminal, Output indication, Mechanical life, and Electrical life (AC1).

Controlling table for CRM-91H, CRM-93H, CRM-9S. Columns include Power on control input, Load between S-A2, Control terminals, Glow tubes connections, Max. amount of glow lamps connected to controlling input, Impulse length, and Reset time.

Other information table for CRM-91H, CRM-93H, CRM-9S. Columns include Operating temperature, Storage temperature, Electrical strength, Operating position, Mounting, Protection degree, Overvoltage category, Pollution degree, Max. cable size (mm²), Dimensions, Weight, and Standards.

- Multifunction time relay can be used for electrical appliances, control of lights, heating, motors, pumps and fans (10 functions, 10 time ranges, multi-voltage, 16 A or 3x 8 A contacts)
Fulfills all requirements for time relays
10 functions:
- 5 time functions controlled by supply voltage
- 4 time functions controlled by control input
- 1 function of latching relay
Comfortable and well-arranged function and time-range setting by rotary switches
Time scale 0.1 s - 10 days divided into 10 ranges: (0.1 s - 1 s / 1 s - 10 s / 0.1 min - 1 min / 1 min - 10 min / 0.1 hrs - 1 h / 1 h - 10 hrs / 0.1 day - 1 day / 1 day - 10 days / only ON / only OFF)
CRM-91H, CRM-93H:
- universal supply voltage AC/DC 12 - 240 V or AC 230 V,
- Output contact: CRM-91H: 1x changeover/SPDT 16 A; CRM-93H: 3 x changeover/SPDT 8 A
CRM-9S:
- universal supply voltage AC 12 - 240 V AC 12 - 240 V, absolutely noise-less switching
- 1x static contactless output (triac) 0.7 A (60 A / < 10 ms), switches potential A1
Multifunction red LED output indicator flashes or shines depending on the status of output
1-MODULE, DIN rail mounting

Description

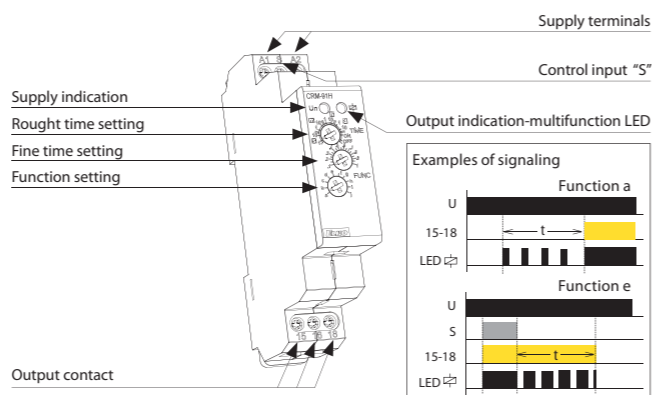

Connection

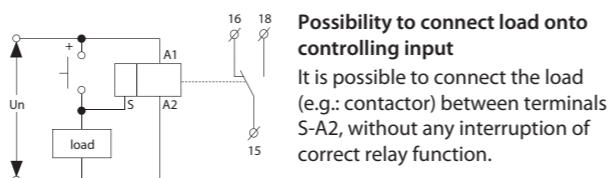
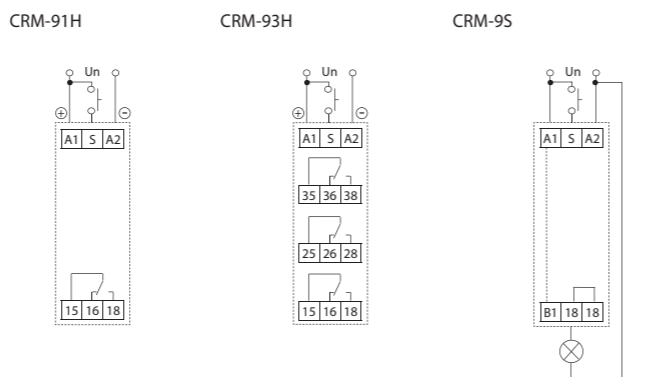

Symbol

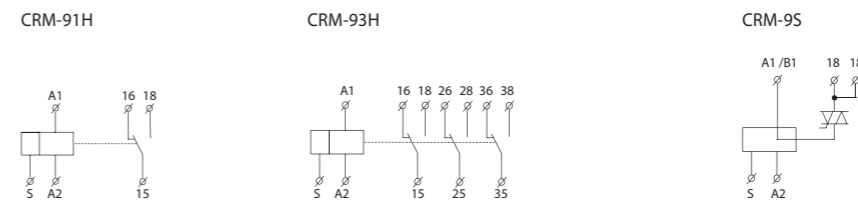

Function

Function diagrams a-j: On Delay (Power On), Off Delay, Repeat Cycle (Starting Off), Repeat Cycle (Starting On), Off Delay (S Break), Single Shot, Single Shot Trailing Edge (Non-Retriggerable), On/Off Delay, Latching relay, Pulse generator. Each diagram shows input voltage U and trigger signal S waveforms with timing delay t.

Time ranges

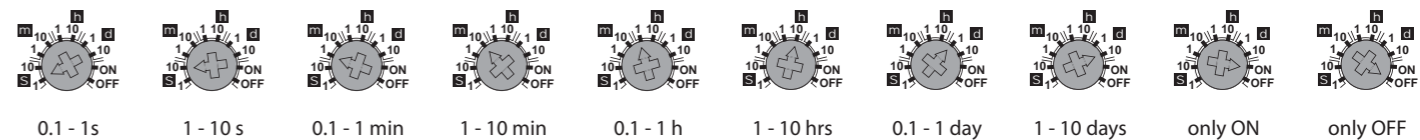

Notes

- 1) Output contacts of CRM-93H do not allow switching of different phases or 3-phase voltages (voltage > 250 V).
2) When mounting into steal-plated switchboards, it is necessary to keep a safety distance of min. 3 mm from terminal's screws 35-36-38 and 25-26-28 towards the shutter of a switchboard.

NEW



EAN code CRM-100: 8595188174534

Technical parameters CRM-100	
Number of functions:	17
Supply terminals:	A1 - A2
Voltage range:	AC/DC 24-240 V (50-60 Hz)
Consumption (apparent / loss):	AC max. 1-4 VA / DC max. 1-3 W
Max. dissipated power (Un + terminals):	4 W
Supply voltage tolerance:	-15 %; +10 %
Time ranges:	0.1 s - 999 hrs.
Time setting:	Buttons SET / ADJ
Repeat accuracy:	± 0.5 % - of selected range
Variation in timing due to voltage change:	± 2%
Variation in timing due to temperature change:	± 5%
Output	
Number of contacts:	1x C/O / SPDT (AgNi)
Current rating:	8 A/ AC1
Breaking capacity:	2000 VA / AC1, 192 W / DC
Inrush current:	10 A / <3s
Switching voltage:	250 V AC1/ 24 V DC
Output indication:	multifunction red LED
Mechanical life:	2 x 10 ⁷
Electrical life (AC1):	1 x 10 ⁵
Controlling	
Control. terminals:	A1-B1
Other information	
Operating temperature:	14 .. 131 °F (-10 .. +55 °C)
Storage temperature:	-22 .. 158 °F (-30 .. +70 °C)
Isolation (Between Input and Output):	2.5 kV
Operating position:	any
Mounting:	DIN rail EN 60715
Protection degree:	IP30 from front panel / IP20 terminals
Overvoltage category:	III.
Pollution degree:	2
Max. cable size (mm ²):	solid wire max. 1x 2.5 or 2x 1.5 / with sleeve max. 1x 2.5 (AWG 12)
Dimensions:	85 x 18.2 x 76 mm (3.3" x 0.7" x 2.99")
Weight:	78 g (2.8 oz.)

- Digital multifunction relay can be used for controlling lights, heating, motors, pumps, machines and appliances where you need set time functions.
- 17 most used functions.
- Thanks to digital display and settings you exact set required time (without any mechanical tolerance).
- Time range 0.1 s - 999 hours
- Universal power supply 24-240 V AC/DC brings you variability of powering.
- 1x 8 A changeover contact.
- Visible time function for non-authorized.
- 1-MODULE, DIN rail mounting.

Description

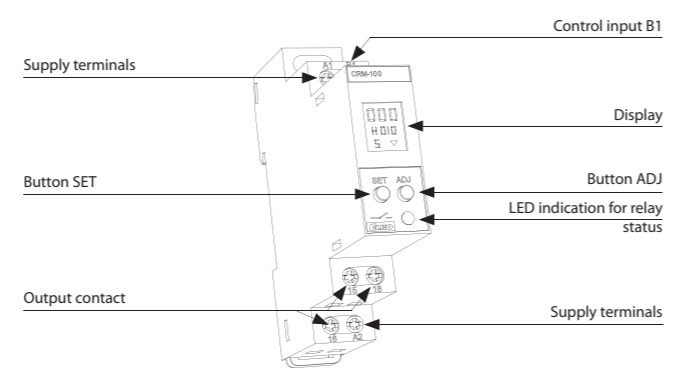

Description of displayed elements on the screen

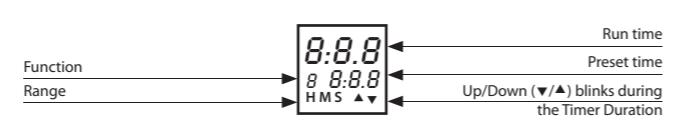

Connection

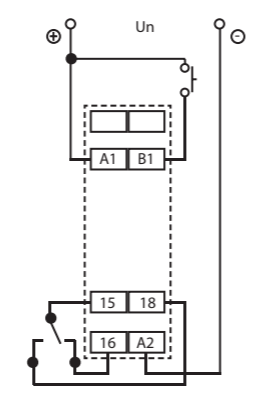

Symbol

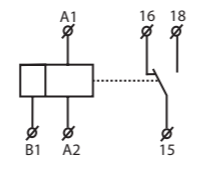

Function

<p>0</p>	<p>ON delay [0] Timing commences when supply is present. R energizes at the end of the timing period.</p>	<p>A</p>	<p>Impulse ON/OFF [A] Permanent supply is required. R energizes for the timing period when B1 is opened or closed. When timing commences, changing state of B1 does not affect R but resets timer.</p>
<p>1</p>	<p>Cyclic OFF/ON (OFF Start, (Sym, Asym)) [1] T-ON and T-OFF can be same or different. The relay (R) keeps on changing its status till power is removed.</p>	<p>B</p>	<p>Signal OFF/ON [B] When switch B1 is closed or opened for preset time T, the relay changes its state after time duration T.</p>
<p>2</p>	<p>Cyclic ON/OFF (On Start, (Sym, Asym)) [2] This function is quite similar to the function '1' but initially the relay(R) is ON for period T-ON after the power is applied.</p>	<p>C</p>	<p>Leading edge impulse1 [C] A permanent supply is needed. When B1 is closed, output relay energizes until timing irrespective of any further action of B1.</p>
<p>3</p>	<p>Impulse ON energizing [3] After power ON, R energizes and timing starts. R de-energizes after timing is over.</p>	<p>D</p>	<p>Leading edge impulse2 [D] Permanent supply is required. when switch B1 is closed, and remains closed output relay energizes until timing is over. If B1 is opened during timing, R resets.</p>
<p>4</p>	<p>Accumulative delay ON signal [4] Time commences as supply is present and switch B1 is open. Closing switch B1 pauses timing. Timing resumes when switch B1 is opened again. R energizes at the end of timing.</p>	<p>E</p>	<p>Trailing edge impulse1 [E] Permanent supply required. when B1 is opened, R energizes and de-energizes when timing is over. If B1 is closed during timing R resets.</p>
<p>5</p>	<p>Accumulative delay ON inverted signal [5] Time commences as supply is present and switch B1 is closed. Opening switch B1 pauses timing. Timing resumes when switch B1 is closed again. R energizes at end of timing.</p>	<p>F</p>	<p>Trailing edge impulse2 [F] Permanent supply is required. When switch B1 is opened, R energizes and will de-energize when timing is over. If B1 is pulsed during timing period it will have no effect on R.</p>
<p>6</p>	<p>Accumulative impulse ON signal [6] When supply is ON, R energizes. When switch B1 is closed timing is suspended and remains suspended till switch B1 is opened again. Interrupting supply resets timer.</p>	<p>G</p>	<p>Delayed impulse [G] When switch B1 is closed, T_{OFF} starts. Relay energizes at the end of T_{OFF} period. Then, T_{OFF} starts irrespective of signal level and relay de-energizes at the end of T_{ON} period.</p>
<p>7</p>	<p>Signal ON delay [7] Permanent supply required. Timing starts when switch B1 is closed. R energizes at end of timing period and de-energizes when B1 is opened.</p>		
<p>8</p>	<p>Inverted signal ON delay [8] Timing will commence when supply is present and switch B1 is open. R energizes after timing. If B1 is closed during timing period, timing resets to the beginning of cycle.</p>		
<p>9</p>	<p>Signal OFF delay [9] Permanent supply is required. R energizes when switch B1 is closed. Timing commences after S is opened and then the relay de-energizes.</p>		



EAN code
CRM-91HE /UNI + potentiometr: 8595188142052
CRM-2HE /UNI + potentiometr: 8595188142069
Potentiometr for CRM-91HE, CRM-2HE : 8595188125215

Table with 3 columns: Technical parameters, CRM-91HE, CRM-2HE. Rows include Number of functions, Supply terminals, Voltage range, Burden, Max. dissipated power, etc.

Table with 2 columns: Potentiometer, CRM-91HE, CRM-2HE. Rows include Potentiometer value, Protection degree, Max. cable size, Weight, Dimensions.

- Control by external control unit - potentiometer (can be placed/ mounted for example on switch board doors or in panel).
• CRM-91HE: multifunction time relays
- 10 functions:
5 time functions controlled by supply voltage
4 time functions controlled by control input
1 function of latching relay
- time scale 0.1 s - 10 days divided into 10 ranges (0.1 s - 1 s / 1 s - 10 s / 0.1 min - 1 min / 1 min - 10 min / 0.1 hrs - 1 h / 1 h - 10 hrs / 0.1 day - 1 day / 1 day - 10 days / only ON / only OFF).
• CRM-2HE: asymmetric cycler
- 2 time functions:
cycler beginning with pulse
cycler beginning with gap
- function selected via external wired link on control input S-A1.
• Universal supply voltage AC/DC 12 - 240 V.
• Output contact: 1x changeover 16 A/SPDT.
• 1-MODULE, DIN rail mounting.
• Possible to connect external potentiometer - max. distance 10 m (32.8 ft.) from relay

Description

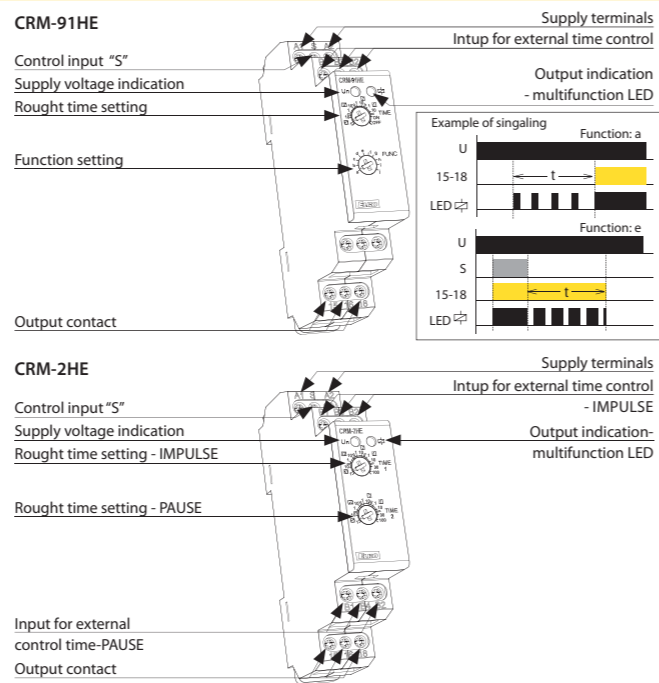

Function

Functions of CRM-91HE are identical with CRM-91H. Functions of CRM-2HE are identical with CRM-2H.

Connection

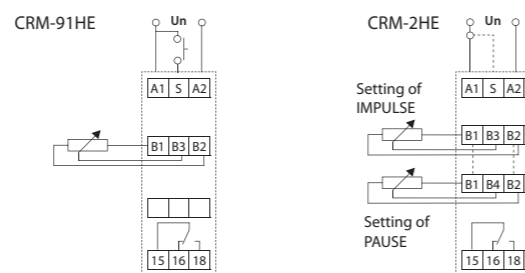

Symbol

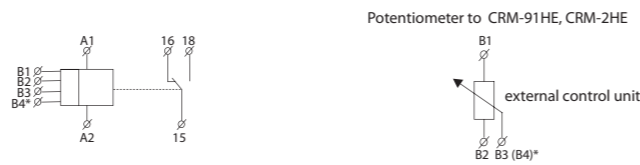

*B4 only for CRM-2HE



EAN code
PRM-91H-8/UNI: 8595188135511
PRM-91H-11/UNI: 8595188111638
PRM-92H/UNI: 8595188111096
PRM-2H/UNI: 8595188111645

Table with 5 columns: Technical parameters, PRM-91H/8, PRM-91H/11, PRM-92H, PRM-2H. Rows include Number of functions, Supply, Voltage range, Burden, Max. dissipated power, etc.

Time ranges

Time ranges of PRM-91H, PRM-92H are identical with CRM-91H. See page 17. Time ranges of PRM-2H are identical with CRM-2H. See page 14.

- Multifunction time relays are equivalents by module types of relay, designed to standardized plug 11 or 8 pin socket
• Pin type enables easy changing, replacement older type of relays (pin-compatible) or easy changing auxiliary relay for time relays
• Multifunction time relay PRM-91H
- 8 or 11 pin type
- 10 time functions, time scale from 0.1 s to 10 days is divided into 10 ranges
- output contact 1x 16 A / 4000 VA, 250 V AC1
• Multifunction time relay PRM-92H
- 11 pin type
- 10 time functions, time scale from 0,1 s to 10 days is divided into 10 ranges
- output contact 2x 8 A / 2000 VA, 250 V AC1
• Asymmetric cycler PRM-2H
- 11 pin type
- 2 time functions, time scale from 0,1 s to 100 days is divided into 10 ranges
- output contact 2x 8 A / 2000 VA, 250 V AC1
• Universal supply voltage AC/DC 12 - 240 V
• Output indication: multif. red LED, flashing at certain states
• PLUG-IN relays

Description

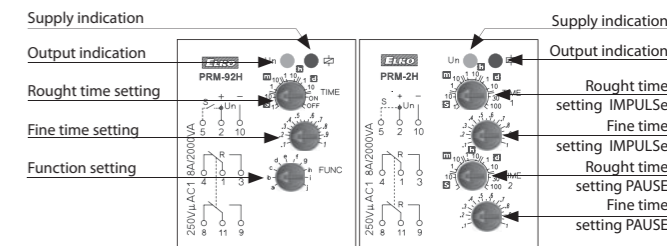

Functions

PRM-91H, PRM-92H: Functions of PRM-91H, PRM-92H are identical with CRM-91H. See page 17.

PRM-2H: Choice Function in PRM-2H is done by connecting terminals 2 and 5.

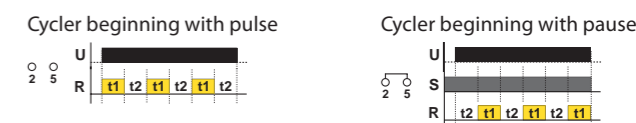

Connection

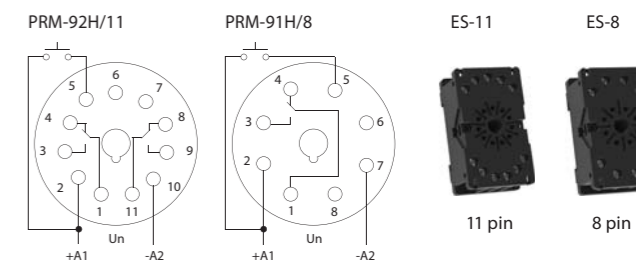

Symbol

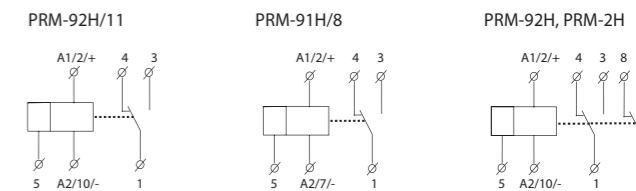

LEGEND TO DESCRIPTION
polarity- outputs/number on module/on socket



EAN code
 PDR-2A /230 V: 859403033037
 PDR-2A /UNI: 859403033044
 PDR-2B /230 V: 859403033051
 PDR-2B /UNI: 859403033068

Technical parameters	PDR-2/A	PDR-2/B
Function:	16	10
Supply terminals:	A1 - A2	
Voltage range:	UNI AC/DC 12 - 240 V (AC 50 - 60 Hz)	
Burden (max.):	AC 0.5 - 2.5 VA / DC 0.4 - 2.5 W	
Voltage range:	230 AC 230 V / 50 - 60 Hz	
Consumption (apparent/loss):	AC max. 16 VA / 2.5 W	
Max. dissipated power (Un + terminals):	5.5 W	
Supply voltage tolerance:	-15 %; +10 %	
Time ranges:	0.01 s - 100 h	
Repeat accuracy:	0.2 % - set value stability	
Temperature coefficient:	0.01 % / °C, at = 20 °C (0.01 % / °F, at = 68 °F)	
Output		
Number of contacts:	2x changeover/ SPDT (AgNi / Silver Alloy)	
Current rating:	16 A / AC1	
Breaking capacity:	4000 VA / AC1, 384 W / DC	
Inrush current:	30 A / < 3 s	
Switching voltage:	250 V AC1 / 24 V DC	
Output indication:	red LED	
Mechanical life:	3x10 ⁷	
Electrical strength (AC1):	0.7x10 ⁹	
Control		
Control input Burden:	AC 0.01 - 0.25 VA (UNI), AC 0.25 VA (AC 230 V)	
Glow lamps:	No	
Control. impulse length:	min. 1 ms / max. unlimited	
Reset time:	max. 200 ms	
Display - colour:	red	
Number and height of digits:	4 positions with separating colon, height 10 mm (0.39")	
Luminance:	2200 - 3800 ucd	
Light wavelength:	635 nm	
Brightness setting:	range 20 - 100 % in 10 steps adjustable	
Memory - memory locations:	30 (PDR-2/A) / 20 (PDR-2/B) for times ranges + service function	
Data stored for:	min. 10 years	
Other information		
Operating temperature:	-20 °C to +55 °C (-4 °F to 131 °F)	
Storage temperature:	-30 °C to +70 °C (-22 °F to 158 °F)	
Electrical strength:	4 kV (supply - output)	
Operating position:	any	
Mounting:	DIN rail EN 60715	
Protection degree:	IP40 from front panel / IP20 terminals	
Overvoltage category:	III.	
Pollution degree:	2	
Max. cable size (mm ²):	solid wire max. 1x 2.5 or 2x 1.5 / with sleeve max. 1x 1.5 (AWG 12)	
Dimensions:	90 x 52 x 65 mm (3.5" x 2" x 2.6")	
Weight:	142 g (5 oz.) (230), 140 g (4.9 oz.) (UNI)	
Standards:	EN 61812-1, EN 61010-1	

- Multifunction programmable digital relay with 4 digit red LED display.
- Control and setting are done by 3 buttons, user-friendly menu, absolute accuracy in timer setting, time countdown on a display, galvanically separated START and STOP control inputs with UNI supply.
- Thanks to its complexity, it is possible to program also more demanding time functions by using 2 independent times.
- 2 independent times, with combination of 2 inputs and 2 outputs.
- **PDR-2/A:** 16 functions, choice of functions of the other relay, 30 memory places for most frequently used times.
- **PDR-2/B:** 10 functions, 1 output of 10 functions can be assigned to each relay = 2 relays in one device.
- 2 independent times in range: 0.01 s - 100 hrs.
- Supply voltage AC/DC 12 - 240 V or AC 230 V.
- 3-MODULE, DIN rail mounting.

Description

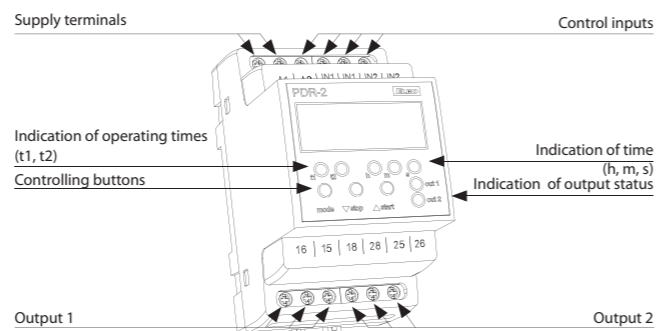

Symbol

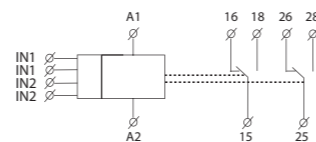

Time data

Time range:	0.01 s - 99 h 59 min 59 sec 99 ss
Minimal time step:	0.01 s
Time deviation:	0.01 % of set value
Setting error:	0 %
Setting, reset accuracy:	100 %
Digital places:	selected via program

Connection

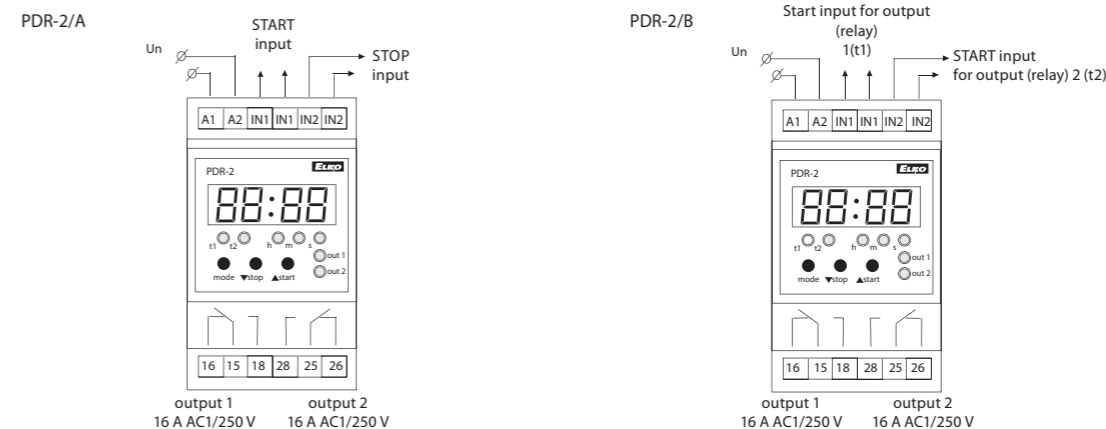

Function

Functions for PDR-2/A and PDR-2/B

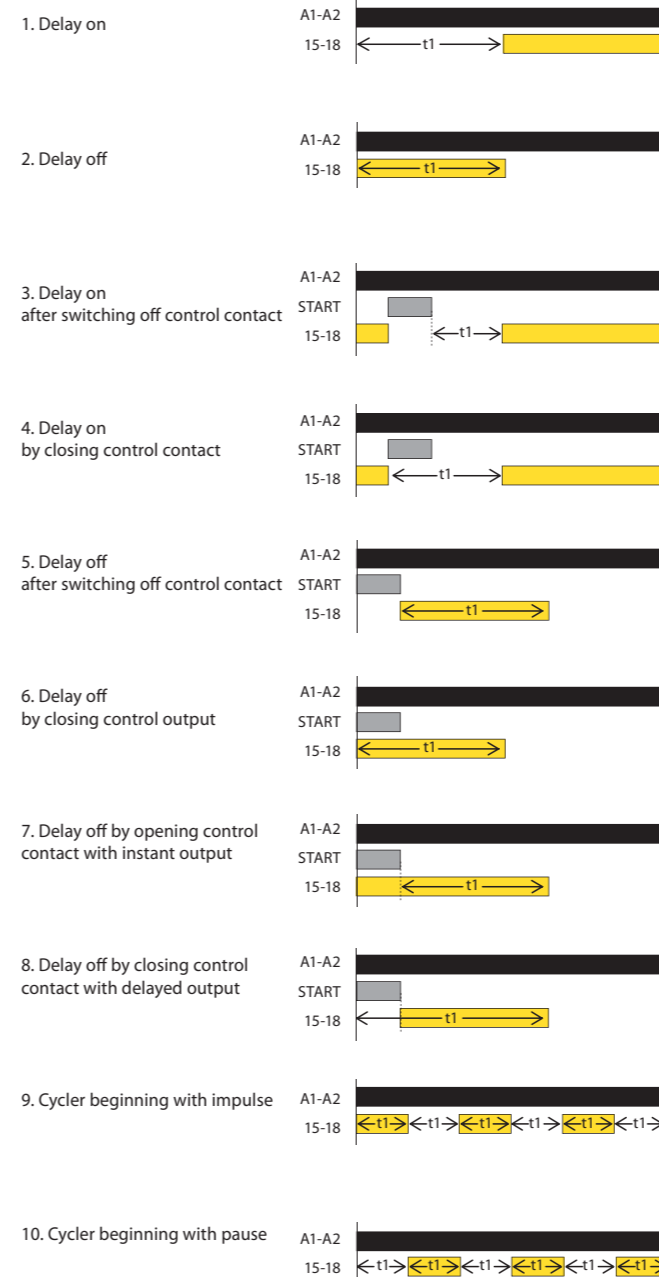

Recommendation:
 PDR-2/B is replacing by 2 simple time relays = 2 in one.

Functions for PDR-2/A

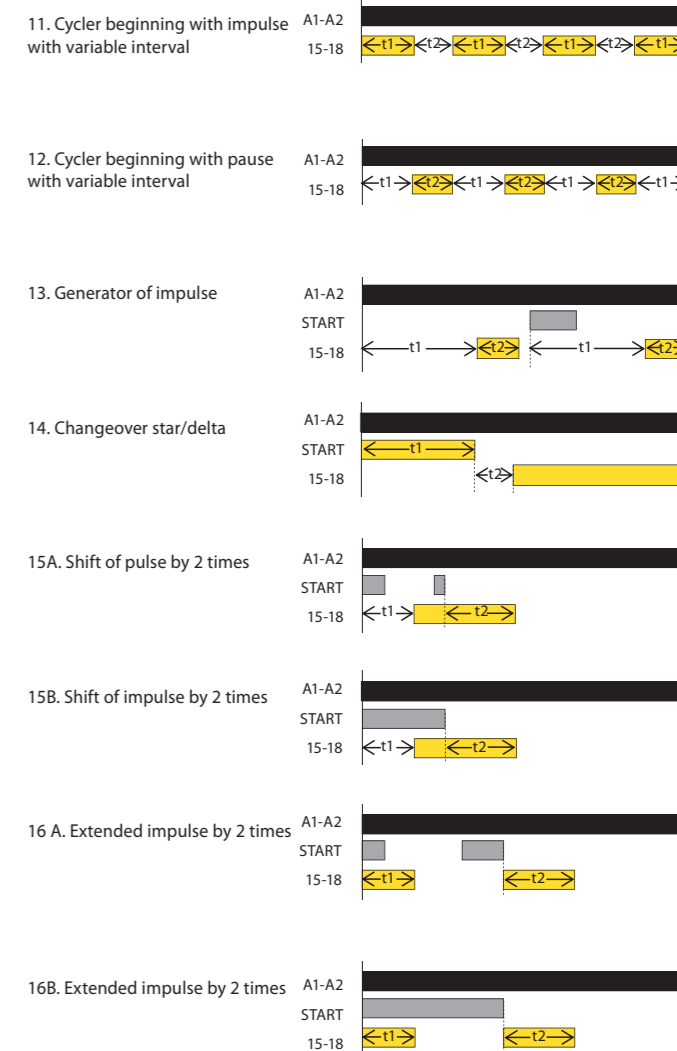



EAN code
 SHT-1 /230 V: 8595188130424
 SHT-1 /UNI: 8595188130431
 SHT-1/2 /230 V: 8595188130400
 SHT-1/2 /UNI: 8595188130417
 SHT-3 /230 V: 8595188136761
 SHT-3 /UNI: 8595188136754
 SHT-3/2 /230 V: 8595188129015
 SHT-3/2 /UNI: 8595188129046

Technical parameters	SHT-1, SHT-3	SHT-1/2, SHT-3/2
Supply terminals:	A1 - A2	
Voltage range:	UNI	AC/DC 12 - 240 V (AC 50 - 60 Hz)
Burden (max.):	AC 0.5 - 2 VA / DC 0.4 - 2 W	
Voltage range:	230	AC 230 V / 50 - 60 Hz
Burden:	AC max. 14 VA / 2 W	
Max. dissipated power (Un + terminals):	3.5 W	5 W
Supply voltage tolerance:	-15 %; +10 %	
Back-up supply:	yes	
Summer/winter time:	automatic	
Output		
Number of contacts:	1x changeover/SPDT (AgSnO ₂)	2x changeover/SPDT (AgSnO ₂)
Current rating:	16 A / AC1	
Breaking capacity:	4000 VA / AC1, 384 W / DC	
Inrush current:	30 A / < 3 s	
Switching voltage:	250 V AC1 / 24 V DC	
Mechanical life:	> 3x10 ⁷	
Electrical life (AC1):	> 0.7x10 ⁵	
Time circuit		
Power back-up:	up to 3 years	
Accuracy:	max. ±1s / day at 23 °C (73.4 °F)	
Minimum interval:	1 min	
Data stored for:	min. 10 years	
Cyclic output:	1 - 99 s	
Pulse output:	1 - 99 s	
Program circuit		
Number of memory places:	100	
Program (SHT-1; SHT-1/2):	daily, weekly	
Program (SHT-3; SHT-3/2):	daily, weekly, monthly, yearly (up to year 2095)	
Data readout:	LCD display, with back light	
Other information		
Operating temperature:	-20 °C to +55 °C (-4 °F to 131 °F)	
Storage temperature:	-30 °C to +70 °C (-22 °F to 158 °F)	
Electrical strength:	4 kV (supply - output)	
Operating position:	any	
Mounting:	DIN rail EN 60715	
Protection degree:	IP10 clips, IP40 from front panel	
Overvoltage category:	III.	
Polution degree:	2	
Max. cable size (mm ²):	solid wire max. 2x 2.5 or 1x 4 with sleeve max. 1x 2.5 or 2x 1.5 (AWG 12)	
Dimensions:	90 x 35 x 64 mm (3.5" x 1.4" x 2.5")	
Weight:	(UNI) - 117 g (4.13 oz.), (230) - 115 g (4.06 oz.), (UNI) - 132 g (4.7 oz.), (230) - 128 g (4.5 oz.)	
Standards:	EN 61812-1, EN 61010-1	

- This time switch clock SHT is used to control various appliances in real time; daily, weekly, monthly and yearly mode.
- Switching: according the program (AUTO)/constantly manually, manually to next program change/random (CUBE).
- „Holiday program” option to choose an interval when the device doesn't switch according to the standard program, but will be block during that time.
- Automatic conversion summer / winter time.
- Sealable cover of front panel, easy controlling via 4 buttons.
- 100 memory places, clear LCD display, min. interval 1 s.
- Voltage range: AC 230 V or AC/DC 12-240 V.
- Cyclic output.
- Pulse output.
- SHT-1, SHT-3: one channel version, 2-MODULE, DIN rail mounting, clamp terminals.
- SHT-1/2, SHT-3/2: two channel version, 2-MODULE, an individual program can be run on each channel.

	Output		Time programm			
	1 channel	2 channel	day	week	month	year
SHT-1	•		•	•		
SHT-1/2		•	•	•		
SHT-3	•		•	•	•	•
SHT-3/2		•	•	•	•	•

Description

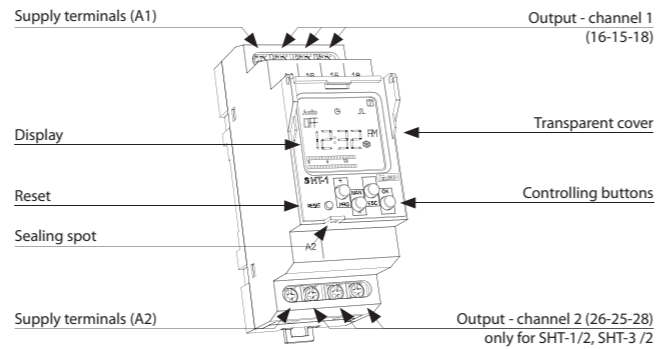

Description of displayed elements on the screen

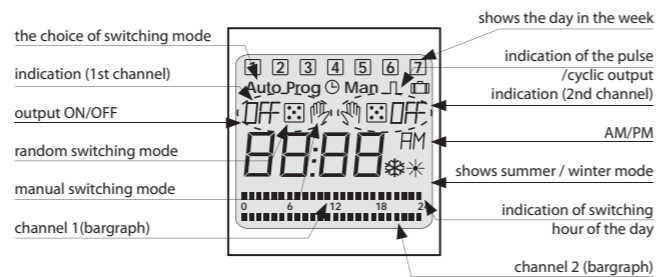

Connection

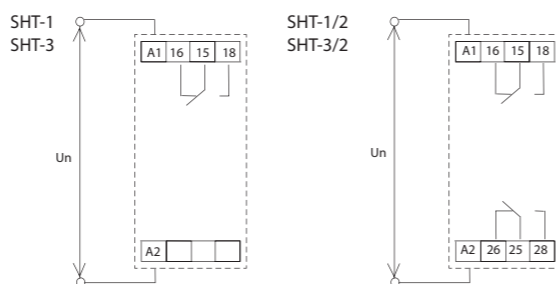

Symbol

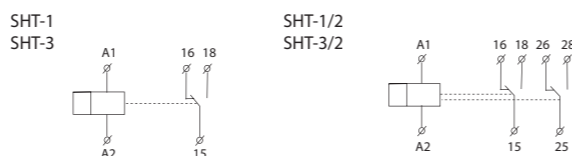

EAN code
 SHT-4: 8595188144759

Technical parameters	SHT-4
Power supply terminals:	A1 - A2
Supply voltage:	AC 230 V / 50 - 60 Hz
Input power:	AC max. 14 VA / 2 W
Max. dissipated power (Un + terminals):	5 W
Supply voltage tolerance:	-15 %; +10 %
Real time back-up:	yes
Transition to summer /winter time:	automatic
Output	
Number of contacts:	2x changeover / SPDT (AgSnO ₂)
Rated current:	16 A / AC1
Switching power:	4000 VA / AC1, 384 W / DC
Peak current:	30 A / < 3 s
Switching voltage:	250 V AC1 / 24 V DC
Mechanical service life:	> 3x10 ⁷
Electrical service life (AC1):	> 0.7x10 ⁵
Timing circuit	
Real time reserve:	up to 3 years
Accuracy of operation:	max. ±1 s per day, at 23°C (73 °F)
Minimum triggering interval:	1 minute
Program data storage period:	10 years at minimum
Programming circuit	
Number of memory locations:	100
Program:	daily, yearly (until 2099)
Data display:	LCD display, backlight
Other information	
Operating temperature:	-20.. +55 °C (-4 °F to 131 °F)
Storage temperature:	-30.. +70 °C (-22 °F to 158 °F)
Electrical strength:	4 kV (power supply - output)
Operating position:	any
Mounting:	DIN rail EN 60715
Protection degree:	IP10 terminals, IP40 from front panel
Overvoltage category:	III.
Polution degree:	2
Max. cable size (mm ²):	max. 2x 2.5, max. 1x 4 with sleeve max. 1x 2.5, max. 2x 1.5 (AWG 12)
Dimensions:	90 x 35 x 64 mm (3.5" x 1.4" x 2.5")
Weight:	128 g (4.5 oz.) - without battery
Standards:	EN 61812-1, EN 61010-1

Plug-in module



Type of backup battery: CR 2032 (3V)

- used for controlling the lighting (billboards, advertisements, shop windows, etc.) with no light sensor required.
- function:
 - by entering the geographic coordinates, the lighting can be switched on/off by sunrise and sunset
 - the preset coordinates for European cities, with optional manual adjustment of the geographical coordinates
 - during programming, 120 minutes may be added to the time of sunrise and sunset
 - selection of ON/OFF functions at sunrise or sunset
 - astro-clock with adjustable interruption
 - operating hours counter for each channel
 - timer - switching on the basis of real-time.
- two-channel design, where each channel is programmable independently of the other.
- automatic switching between winter and summer time.
- sealable transparent cover on the front panel.
- data and time backup using the battery.
- battery life - up to 3 years.
- easy replacement of the backup battery through the plug-in module, no disassembling is required.
- supply voltage: AC 230 V.
- 2-MODULE, DIN rail mounting.

Description

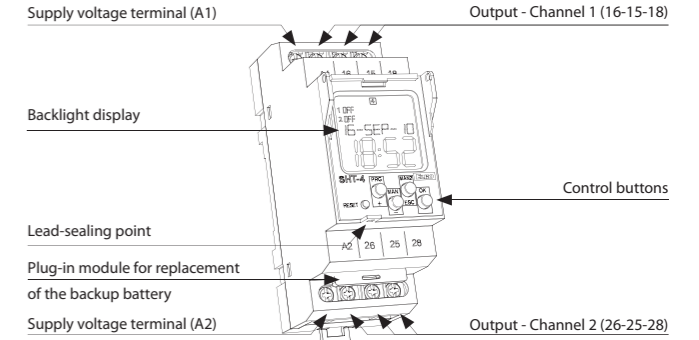

Description of items displayed on the screen

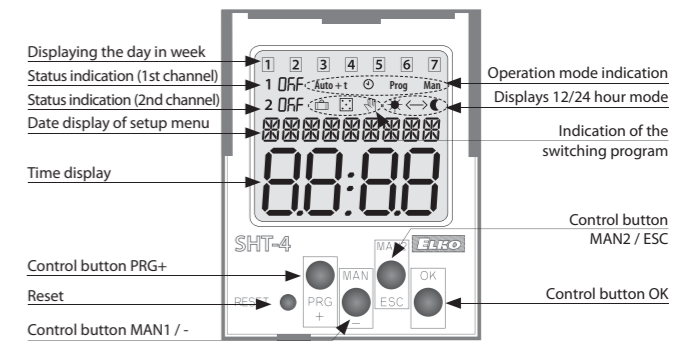

Wiring

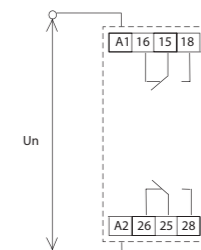

Symbol

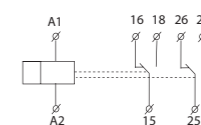



EAN code
SHT-6: 8595188148382
DCFR-1: 8595188148412

Technical parameters		SHT-6
Terminals supply:	A1 - A2	
Voltage supply:	AC 230 V / 50 - 60 Hz	
Burden (max.):	8 VA / 0.7 W	
Max. dissipated power (Un + terminals):	3.5 W	
Tolerance of voltage supply:	-15 %; +10 %	
Output		
Number of contacts:	1 x changeover (AgSnO ₂)	
Rated current:	16 A / AC1	
Switching capacity:	4000 VA / AC1, 384 W / DC	
Peak current:	30 A / < 3 s	
Max. switching voltage:	250 V AC1 / 24 V DC	
Mechanical life:	> 3x10 ⁷	
Electrical life (AC1):	> 0.7x10 ⁵	
Time circuit		
Backup real. time:	up to 3 years	
Running accuracy		
- without DCF receiver:	max. ±1 s per day with 23°C (73 °F)	
Minimum switching interval:	1 min	
Data retention programs:	min. 10 years	
Program circuit		
Number of memory locations:	100	
Program:	daily, yearly (till year 2099)	
Displayed data:	LCD display with backlight	
Other information		
Working temperature:	-10.. +55 °C (14 to 131 °F)	
Storage temperature:	-30.. +70 °C (-22 °F to 158 °F)	
Dielectric strength:	4 kV (output supply)	
Operating position:	any	
Mounting:	DIN rail EN 60715	
Protection:	IP10 terminals, IP40 from the front panel	
Over voltage category:	III.	
Degree of pollution:	2	
Max. cable size (mm ²):	max. 2x 2.5, max. 1x 4 with sleeve max. 1x 2.5, max. 2x 1.5 (AWG 12)	
Dimensions:	90 x 35 x 64 mm (3.5" x 1.4" x 2.5")	
Weight:	114 g (4 oz.) - without battery	
Standards:	EN 61812-1, EN 61010-1	

Plug-in module



Type of backup battery: CR 2032 (3V)

- Used for controlling appliances depending on real time, that is synchronized by a DCF 77 signal, thanks to the automatic time settings (with DCF 77 signal) it eliminates inaccuracies and errors by time running.
- 1 channel design with external DCF receiver.
- automatic switching between winter/summer time.
- sealable cover of the front panel.
- 100 memory places.
- backlit LCD display.
- switching according to the program: auto / manual / random / holiday program.
- Function of the operating hours counter.
- backing up data and time using the battery.
- reserve battery for up to 3 years.
- Easy replacement for the backup battery with plugging module without dismantling the device.
- Power supply: AC 230 V.
- 2-MODULE, mounting on DIN rail.

Description

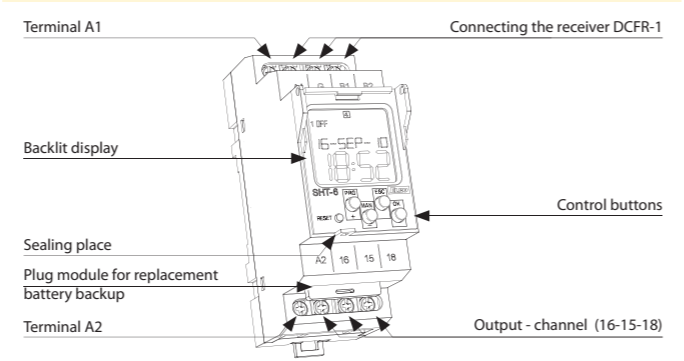

Description of the displayed elements on the screen

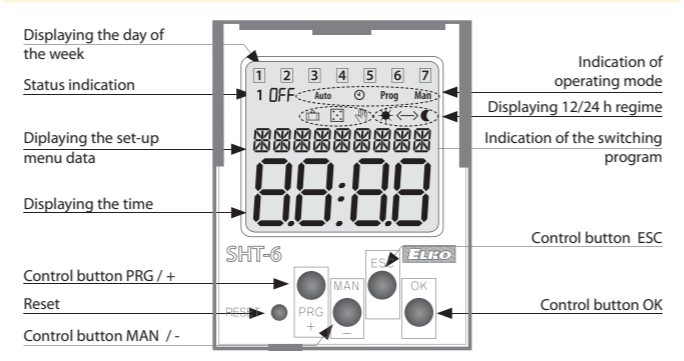

Connection

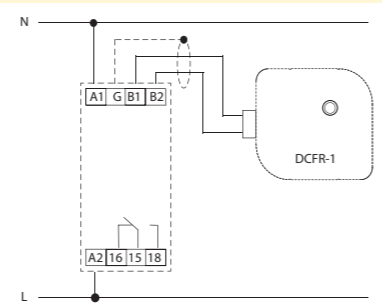

Symbol

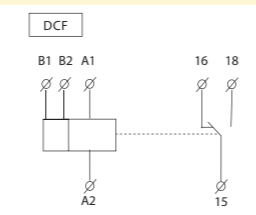

EAN code
DCFR-1: 8595188148412

Technical parameters		DCFR-1
Connection:	2 conductors	
Max. cross-connection conductors:	2.5 mm ²	
Max voltage on the wires:	10 V	
Indication Function:	red LED	
Other information		
Storage temperature:	-30.. +70 °C (-22 to 158 °F)	
Protection:	IP65	
Dimensions:	98 x 62 x 34 mm (39.3 x 2.4 x 1.3")	
Weight:	110 g (3.88 oz)	
Operating position:	perpendicular to the direction of reception	
The reception area:	about 1500 km from Frankfurt / Main	

- Universal DCF module, which is designed for controlling the SHT-6 timer, and other devices.
- outdoor applications (IP65 protection).
- Two-wire connection - not polarity sensitive!
- Length of connecting cable is up to 100 m (328').
- visual indication of proper function module.

Description

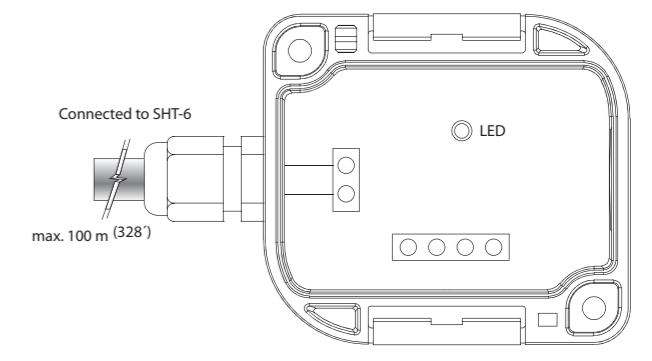

Working position - options

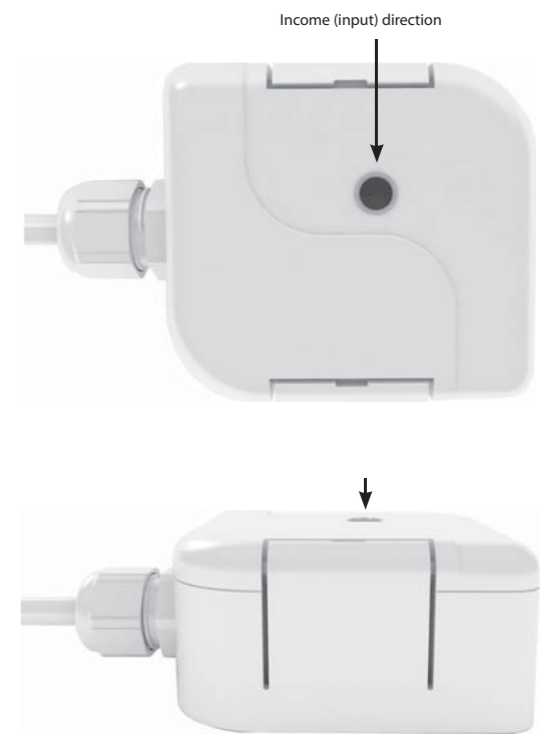

NEW



EAN code SHT-7: 8595188135498



Technical parameters		SHT-7
Power supply terminals:	A1 - A2	
Supply voltage:	AC 230 V / 50 - 60 Hz	
Input power:	AC max. 14 VA / 2 W	
Max. dissipated power (Un + terminals):	5 W	
Supply voltage tolerance:	-15 %; +10 %	
Real time back-up:	yes	
Transition to summer /winter time:	automatic	
Output		
Number of contacts:	2x changeover / SPDT (AgSnO ₂)	
Rated current:	16 A / AC1	
Switching power:	4000 VA / AC1, 384 W / DC	
Peak current:	30 A / < 3 s	
Switching voltage:	250 V AC1 / 24 V DC	
Mechanical service life:	> 3x10 ⁷	
Electrical service life (AC1):	> 0.7x10 ⁵	
Timing circuit		
Real time reserve:	up to 3 years	
Accuracy of operation:	max. ±1 s per day, at 23°C (73 °F)	
Minimum triggering interval:	1 minute	
Program data storage period:	10 years at minimum	
Programming circuit		
Number of memory locations:	100	
Program:	daily, yearly (until 2099)	
Interface NFC:	daily, yearly (until 2099)	
Data display:	LCD display, backlight	
Other information		
Operating temperature:	-20.. +55 °C (-4 °F to 131 °F)	
Storage temperature:	-30.. +70 °C (-22 °F to 158 °F)	
Electrical strength:	4 kV (power supply - output)	
Operating position:	any	
Mounting:	DIN rail EN 60715	
Protection degree:	IP10 terminals, IP40 from front panel	
Overvoltage category:	III.	
Polution degree:	2	
Max. cable size (mm ²):	max. 2x 2.5, max. 1x 4 with sleeve max. 1x 2.5, max. 2x 1.5 (AWG 12)	
Dimensions:	90 x 35 x 64 mm (3.5" x 1.4" x 2.5")	
Weight:	125 g (4.4 oz.) - without battery	
Standards:	EN 61812-1, EN 61010-1	

- Digital switch timer clock with day and year program and setting via smartphone supporting NFC transfer
- Timer switch - switching based on real time in day and week mode
- 100 memory locations for on / off setting
- OFF line setting of programs in the application
- Backup / insertion into the phone memory for transfer to the next timer switch
- two-channel design, where each channel is programmable independently of the other.
- automatic switching between winter and summer time.
- sealable transparent cover on the front panel.
- data and time backup using the battery.
- battery life - up to 3 years.
- easy replacement of the backup battery through the plug-in module, no disassembling is required.
- supply voltage: AC 230 V.
- 2-MODULE, DIN rail mounting.

Description

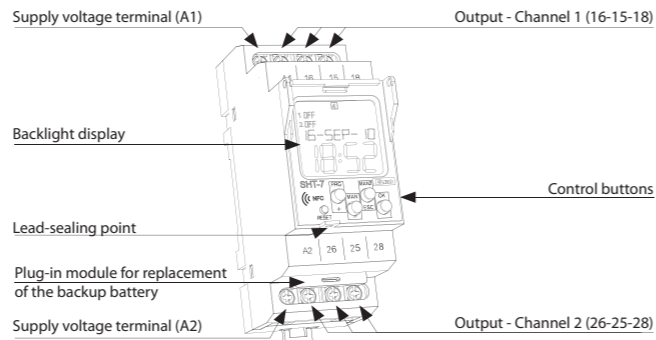

Description of items displayed on the screen

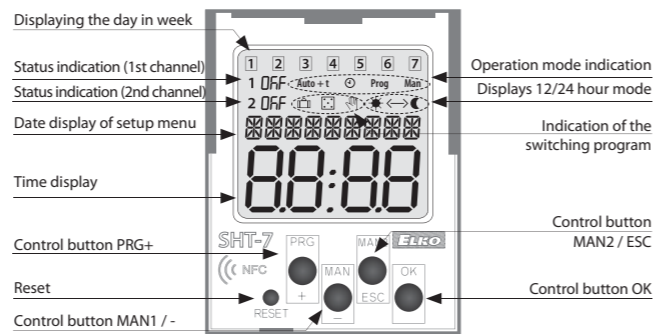

Wiring

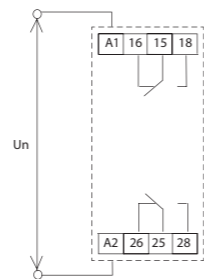

Symbol

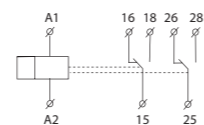

Plug-in module



With battery Without battery

Type of backup battery: CR 2032 (3V)



Through simple steps in the application you can set the desired on and off settings based on real time. You can copy this setting to other days, and altogether you can store up to 100 programs. The entire setup project can be saved to your smartphone and transferred to the next timer switch. The smartphone application serves not only to upload settings but also to download. The main benefit is speed and simplicity.



Near Field Communication is the way of wireless communication of two devices within a short distance of a few centimeters. A typical example of NFC is credit card payment, but now our ability to control your timing clock is also an option. You can also conveniently set it up using a smartphone and transfer these set modes to other devices, clone them or back them up.



EAN code
 SMR-K /230 V: 8595188145176
 SMR-T /230 V: 8595188129107
 SMR-H /230 V: 8595188129114
 SMR-B /230 V: 8595188135566

Technical parameters	SMR-K	SMR-T	SMR-H	SMR-B
Number of functions:	9			10
Connection:	3-wire, without neutral		4-wire, with neutral	
Voltage range:	AC 230 V / 50 - 60 Hz			
Power input (no operation/make):	max. 0.8 / 3 VA		max. 1 / 1 VA	
Supply voltage tolerance:	-15 %; +10 %			
Time ranges:	0.1 s - 10 days			
Time setting:	via rotaty switch			
Time deviation:	10 % - mechanical setting			
Repeat accuracy:	2 % - set value stability			
Temperature coefficient:	0.1 % / °C, at = 20 °C (0.1 % / °F, at = 68 °F)			
Output				
Number of contacts:	1 x triac			1x NO-SPST (AgSnO ₂)
Resistive load:	10 - 160VA	0 - 200VA	250 V AC1	
Inductive load:	10 - 100VA	0 - 100VA	8A 250V AC (cos φ > 0.4)	
Control				
Control voltage:	AC 230 V			AC 230V, UNI 5-250 V AC/DC
Control current:	25µA	3 mA		
Impulse length:	min. 50 ms / max. unlimited			
Glow tubes connctions:	x	Yes		
Max. amount of glow lamps connected to controlling input:	230 V - max. amount 50 pcs (measured with glow lamp 0.68 mA/230 V AC)			
Other information				
Operating temperature:	0.. +50 °C (+32.. +122 °F)			
Operating position:	any			
Mounting:	free at connecting wires			
Protection degree:	IP 30 in standard conditions*			
Overvoltage category:	III.			
Pollution degree:	2			
Fuse:	F 1 A / 250 V			x
Connection wires (cross-section / lenght):	3x CY, 0.75 mm ² (AWG 18) 90 mm (3.5")	4x sol. wir., 0.75 mm ² (AWG 18) 90 mm (3.5")	2x CY, 0.75mm ² (AWG 18), 2x CY, 2.5 mm ² (AWG 10), 90 mm	
Glow-lamps in control button:	x	max. 10		max. 20
Dimensions:	49 x 49 x 13 mm (1.9" x 1.9" x 0.5")			
Weight:	27 g(0.95 oz.)	27 g(0.95 oz.)	28 g(0.98 oz.)	53 g (1.9 oz.)
Standards:	EN 61812-1, EN 61010-1			

* for more information see page 41

- Multifunction relay designed for installation into a wiring box or under wall-switch in an existing electrical installation.
- Advantageous and fast solution for exchanging standard wall-switch for a switch controlled by time or for an impulse relay controlled by a button.
- More information about type and size of load for these products can be found on page 161.
- **SMR-K**
 - 3-wire connection, works without the connection of a neutral conductor
 - power output: 10-160 VA
 - for flawless function of the product is necessary the presence of a load R, L or C between input S and neutral wire
- **SMR-T**
 - 3-wire connection, works without the connection of a neutral conductor
 - power output: 10 - 160 VA
 - between input S and neutral wire is possible connect any load R, L, or C - that is not necessary (unlike SMR-K)
- **SMR-H**
 - 4-wire connection
 - power output: 0 - 200 VA
- **SMR-B**
 - 4-wire connection
 - 10 functions
 - output contact 1x 16 A / 4000 VA, 250 V AC1
 - enables switching of fluorescent lights and also energy saving lights
 - suitable for switching loads greater than SMR-K, SMR-T, SMR-H, for example pulse relay, stair automatic switch, switching of ladder radiators in bathrooms
 - independent galvanically separated input AC/DC 5 - 250 V, for example for control from a security system

Description

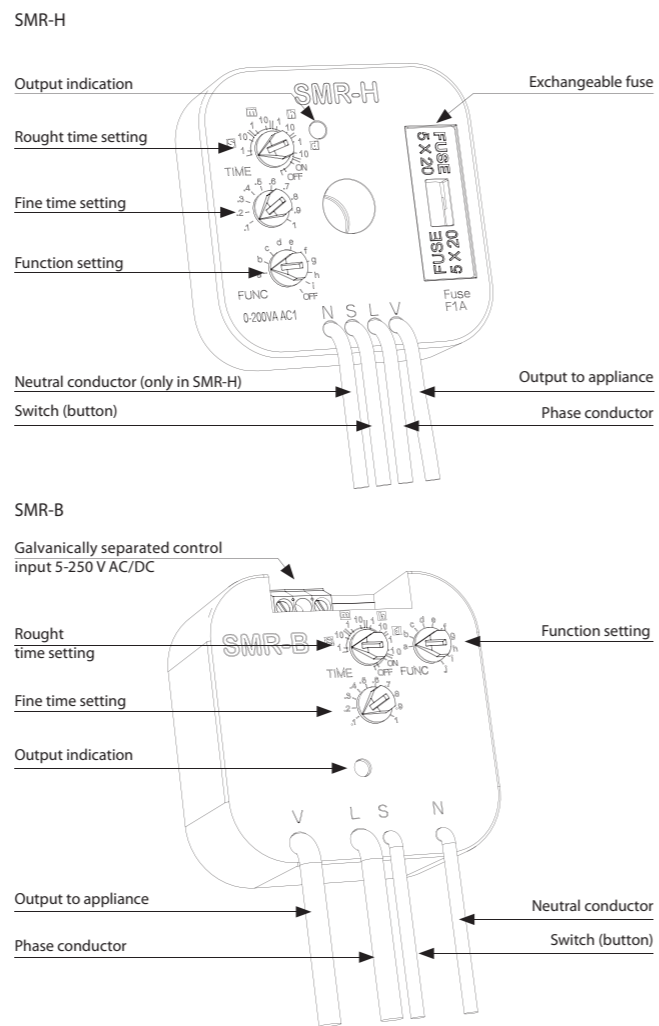

Function

Function a - delay on entering edge
 output times when it is switched. Each following pressing (max. 5x) increases time. Long pressing swithes output off

Function b - delay on downward edge
 output times after button is swithed off, switches immediately

Function c - delay on downward edge
 after swithing off output switches on and times.

Function d - cyler - flasher impulsem
 output cycles in regular interval, cyler starts with an impulse

Function e - puls shift
 delay on after the switch is swithed on and delay on after it is swithed off

Function f - delay on
 delay on after switch is swithed on until it is swithed off

Function g - impulse relay
 swithes on by a press, another pressing swithes the output off. The length of pressing doesn't matter, it is possible to set reaction delay by a potentiometer and thus eliminate rebound of a button

Function h - impulse relay with delay
 one press swithes on, another one swithes the output off in case it is done before the end of timing

Function i - cyler starting with pause
 output cycles in regular intervals, cyler starts with a pause

Function j* - cyler starting with gap
 delay ON until swithed off until it is de-energized or a switch is pressed again.
 Note.: *- Function j is valid only for SMR-B

Connection SMR-K, SMR-T, SMR-H, SMR-B

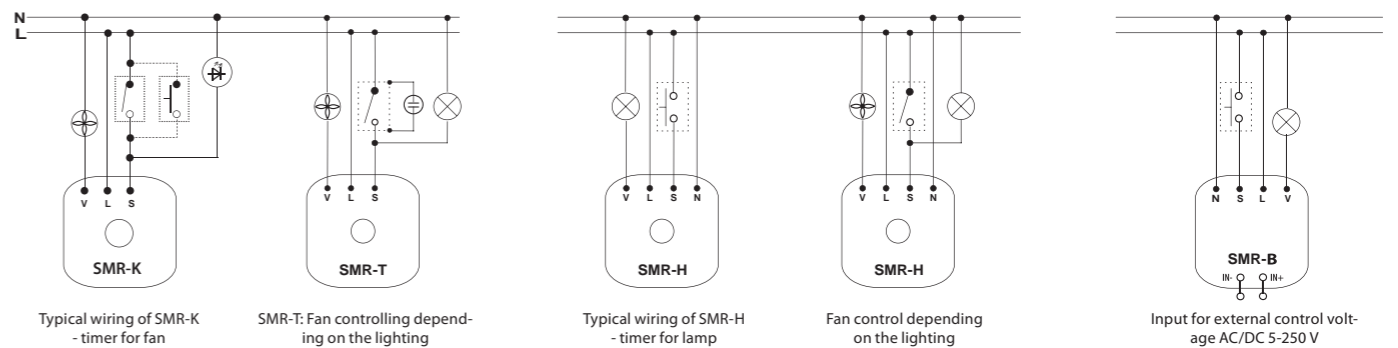

Note: SMR-K, SMR-T, SMR-H are not intended for switching capacity load (energy saving bulbs and LED lights with capacity power etc.), these products are only intended for switching resistive and inductive loads (incandescent bulbs, fans, etc.). SMR-B with relay output is intended to other types of load. Using this output it is possible to switch the load of R, L or C-values listed in the load table. Between inputs S and neutral wire is possible to connect any load of R, L or C, however this is not (unlike the SMR-K) condition.

Example of connection SMR-T

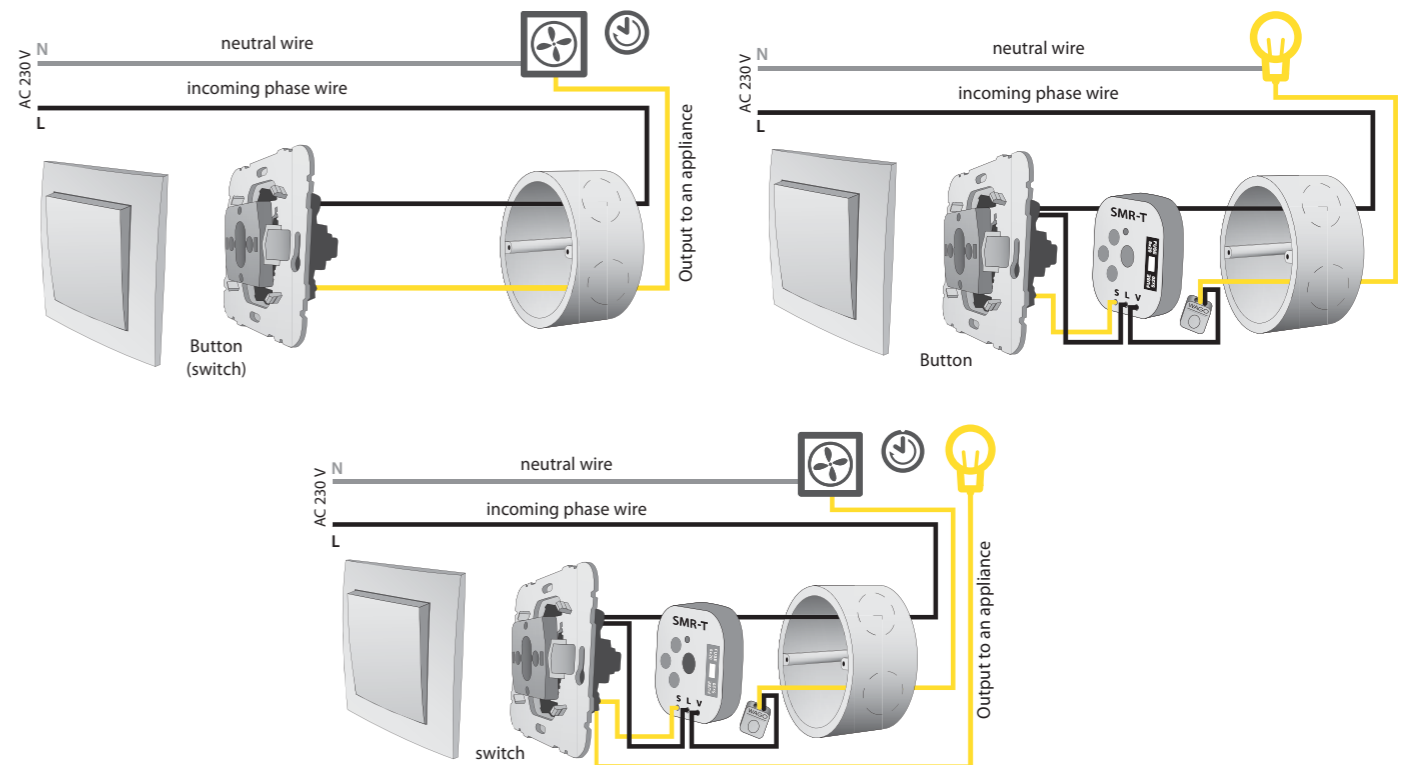



EAN code
CRM-42/230 V: 8595188136693
CRM-42F/230 V: 8595188146883

Technical parameters	CRM-42	CRM-42/F
Function:	delay OFF responsive to control contact switch on	
Supply terminals:	A1 - A2	
Voltage range:	AC 230 V / 50 - 60 Hz	
Burden:	AC max. 12 VA / 1.8 W	
Max. dissipated power (Un + terminals):	4 W	
Supply voltage tolerance:	-15 %; +10 %	
Supply indication:	green LED	
Time ranges:	0.5 - 10 min	
Time setting:	potentiometer	
Time deviation:	5 % - mechanical setting	
Repeat accuracy:	5 % - set value stability	
Temperature coefficient:	0.05 % / °C, at = 20 °C (0.05 % / °F, at = 68 °F)	
Output		
Number of contacts:	1x NO - SPST (AgSnO ₂), switches potencial A1	
Current rating:	16 A / AC1	
Breaking capacity:	4000 VA / AC1, 384 W / DC	
Inrush current:	30 A / < 3 s	
Switching voltage:	250 V AC1 / 24 V DC	
Output indication:	red LED	
Mechanical life:	3x10 ⁷	
Electrical life (AC1):	0.7x10 ⁵	
Electrical life (AC5b):	8x10 ⁴ (bulbs 1000 W) *	
Control		
Control voltage:	AC 230 V	
Input Burden:	AC 0.53 VA	
Glow tubes connctions:	Yes	
Max. amount of glow lamps connected to controlling input:	230 V - max. amount 50 pcs (measured with glow lamp 0.68 mA / 230 V AC)	
Control. terminals:	A1-S or A2-S	
Impulse length:	min. 50 ms / max. unlimited	
Reset time:	max. 150 ms	
Other information		
Operating temperature:	-20 °C to +55 °C (-4 °F to 131 °F)	
Storage temperature:	-30 °C to +70 °C (-22 °F to 158 °F)	
Operating position:	any	
Mounting:	DIN rail EN 60715	
Protection degree:	IP40 from front panel / IP10 terminals	
Overvoltage category:	III.	
Pollution degree:	2	
Max. cable size (mm ²):	solid wire max. 2x 2.5 or 1x 4, with sleeve max. 1x 2.5 or 2x 1.5, (AWG 12)	
Dimensions:	90 x 17.6 x 64 mm (3.5" x 0.7" x 2.5")	
Weight:	69 g (2.4 oz.)	
Standards:	EN 60669-2-3, EN 61010-1	

- Intelligent staircase switch, the same use as CRM-4, but with enlarged possibility of control in mode „PROG“, it is possible to select time of delayed OFF by number of button pressing. Each pressing multiplies time set by potentiometer, it means that in case you set time to 5 min and press the button 3 times, then the output is automatically prolonged to 15 min. Output can be also switched off before time (reset) by long pressing of button (longer than 2 sec).
- Output relay contact 16 A/AC1 with inrush current up to 80 A enables switching of el. bulbs and also fluorescent lights.
- Operating system switch:
 - ON - output is constantly ON (service mode).
 - AUTO - timing according to adjusting by potentiometer in range 30 s - 10 min.
 - PROG - timing with time prolongation option by number button pressing.
- Timing (in mode AUTO and PROG) is possible to be stopped by long pressing of the button (> 2 s).
- Voltage range: AC 230 V, clamp terminals.
- Output indication: multif. red LED, flashing at certain states
- 3-wire or 4-wire connection (it is possible to control input S by potential A1 or A2).
- CRM-42:** Warning before switch OFF- output doubleflash 40 and 30 sec before switch OFF.
- CRM-42F:** Staircase switch without warning flashes especially suited for use with energy-saving lamps, where frequent flashing may cause damage to the light source.
- 1- MODULE, DIN rail mounting.

Description

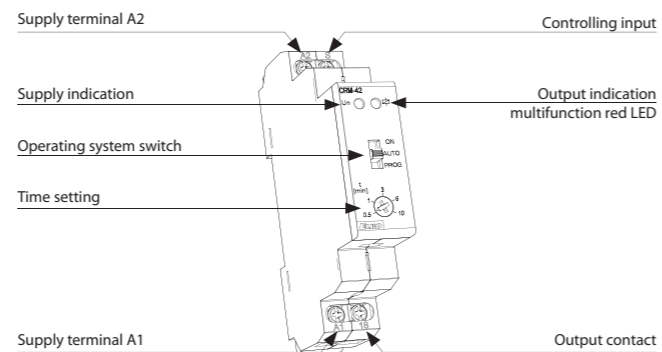

Connection

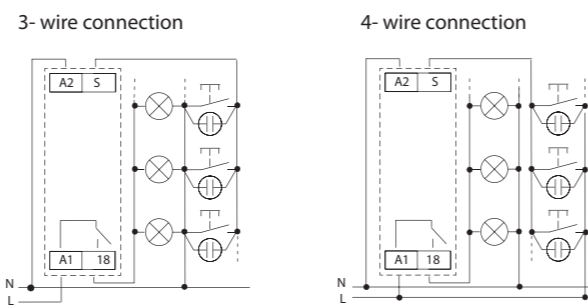

Symbol

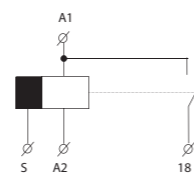

* For bigger bulb loads and frequent switching is recommended to intensify the contact relay with power contactor e.g. VSXXX

Function

MODE ON

- the output is permanently closed in ON position. Control input is blocked.



MODE AUTO

- by pressing a control button in function AUTO the output closes and after the set time period the output opens.

CRM-42: Warning before switch OFF- output doubleflash 40 and 30 sec before switch OFF*

CRM-42F: without flashing

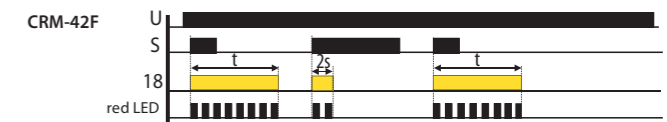
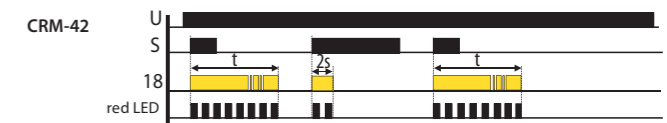

MODE PROG (the illumination time is defined by number of button pressing)

- in function program the switched time is a sum of each time set by pressing the button. By pressing >2s the output opens.

CRM-42: Warning before switch OFF- output doubleflash 40 and 30 sec before switch OFF*

CRM-42F: without flashing

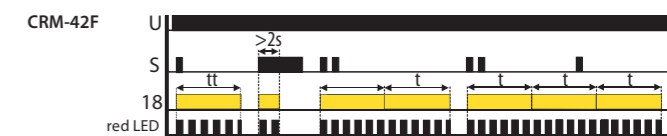
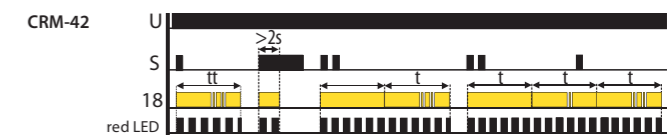

* If the total set time is less than 1 min, there is no flashing according to the graph of the function.



EAN code
CRM-4 / 230 V: 8595188115605

Technical parameters		CRM-4
Function:	delay off reacting to control contact switching	
Supply terminals:	A1 - A2	
Voltage range:	AC 230 V / 50 - 60 Hz	
Burden:	AC max. 12 VA / 1.8 W	
Max. dissipated power (Un + terminals):	4 W	
Supply voltage tolerance:	-15 %; +10 %	
Supply indication:	green LED	
Time ranges:	0.5 - 10 min	
Time setting:	potentiometer	
Time deviation:	10 % - mechanical setting	
Repeat accuracy:	5 % - set value stability	
Temperature coefficient:	0.05 % / °C, at = 20 °C (0.05 % / °F, at = 68 °F)	
Output		
Number of contacts:	1x changeover / SPDT (AgSnO ₂)	
Current rating:	16 A / AC1	
Breaking capacity:	4000 VA / AC1, 384 W / DC	
Inrush current:	30 A / < 3 s	
Switching voltage:	250 V AC1 / 24 V DC	
Output indication:	red LED	
Mechanical life:	3x10 ⁷	
Electrical life (AC1):	0.7x10 ⁵	
Control		
Control voltage:	AC 230 V	
Power on input:	AC 0.53 VA	
Load between S-A2:	Yes	
Control terminals:	A1-S	
Glow tubes connections:	Yes	
Max. amount of glow lamps connected to controlling input:	max. amount 35 pcs (measured with glow lamp 0.68 mA / 230 V AC)	
Impulse length:	min. 25 ms / max. unlimited	
Reset time:	max. 150 ms	
Other information		
Operating temperature:	-20 °C to +55 °C (-4 °F to 131 °F)	
Storage temperature:	-30 °C to +70 °C (-22 °F to 158 °F)	
Electrical strength:	4 kV (supply - output)	
Operating position:	any	
Mounting:	DIN rail EN 60715	
Protection degree:	IP40 from front panel / IP20 terminals	
Overvoltage category:	III.	
Pollution degree:	2	
Max. cable size (mm ²):	solid wire max. 1x 2.5 or 2x 1.5 / with sleeve max. 1x 2.5 (AWG 12)	
Dimensions:	90 x 17.6 x 64 mm (3.5" x 0.7" x 2.5")	
Weight:	67 g (2.3 oz.)	
Standards:	EN 60669-2-3, EN 61010-1	

- Used for delayed switching of lights in the corridors, entrances, stairways, halls or for delayed finish of fans (WC, bathroom, etc.).
- It is controlled by a button or by several buttons from more places (connected in parallel), buttons can be equipped by glow lamps (max. 20 pcs of glow lamps).
- Output relay contact 16 A / AC1 with surge current up to 80 A enables switching of el. bulbs and fluorescent lamps.
- Operating system switch:
 - AUTO - normal function according to set time.
 - OFF - permanently OFF (e.g. when changing bulbs).
 - ON - permanently ON (e.g. while cleaning, servicing).
- Time range: 0.5 - 10 min.
- Time setting by potentiometer.
- Supply voltage : AC 230 V.
- Protection against button blocking (e.g. a match inserted in a button).
- 1- MODULE, DIN rail mounting.

Description

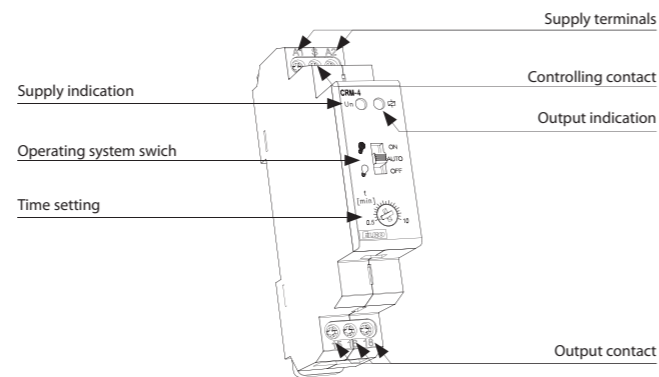

Circuit connection

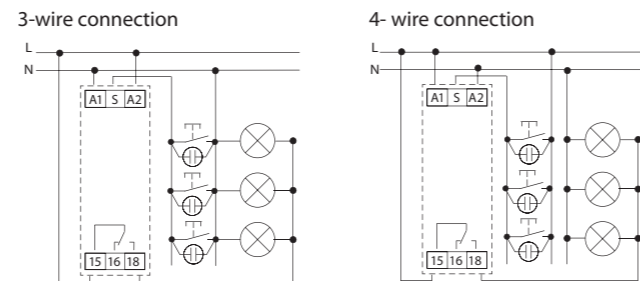

Symbol

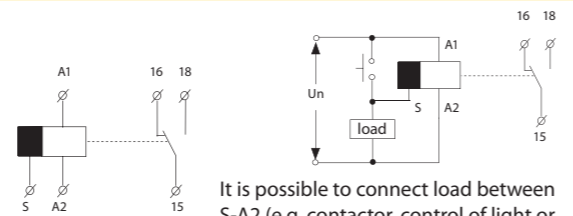

It is possible to connect load between S-A2 (e.g. contactor, control of light or any other device), without disturbing a correct function of relay (load is energized while the switch is ON).

Function

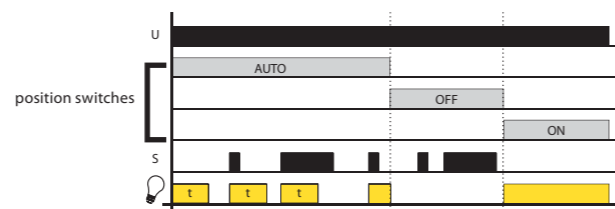

VS(B,K)

VS116B/230 Supply voltage: AC 230 V Output contact: 1x changeover/ SPDT 16 A.	VS116K Supply voltage: AC 230 V and AC/DC 24 V Output contact: 1x changeover/ SPDT 16 A.	VS308K Supply voltage: AC 230 V and AC/DC 24 V Output contacts: 3x changeover/ TPDT 8 A.	VS316/24 Supply voltage: AC/DC 24 V Output contacts: 3x changeover/TPDT 16 A, possibility to be connected into 3-phase circuit.	VS316/230 Supply voltage: AC 230 V Output contacts: 3x changeover/ TPDT 16 A, possibility to be connected into 3-phase circuit.

VS(U)

VS116U Supply voltage: AC/DC 12-240 V Output contact: 1x changeover/SPDT 16 A.	VS308U Supply voltage: AC/DC 12-240 V Output contacts: 3x changeover/ TPDT 8 A.

782L

782L Power relays plug-in Output contacts: 4 x changeover contact/ SPDT 6 A. Plug-in type.	ES-15/4N - socket Max. voltage: 12 A Weight: 59 g Mounting to DIN rail Intended for 4-contact relay.

750L

750L Power relays plug-in Output contacts: 3 x changeover contact / SPDT 10 A. Plug-in type.	ES-11 - socket Max. current: 10 A Weight: 60 g Mounting to DIN rail Intended for 3-contact relay.

Overview table

Type	Design	Coil voltage	Output contact	Other features			Designation	Page of catalogue
				LED signal light	RC unit	Parallel diode		
VS116B/230	MINI	AC 230 V/50-60 Hz	1x16 A changeover/ SPDT	●	x	x	VS116/B230 MINI, with installation into junction box or ceiling that allows control of lights, shades or awnings drives	36
VS116K	1M-DIN	AC 230 and AC/DC 24 V	1x16 A changeover/ SPDT	●	●	●	as a separation relay (4kV), direct switching of appliances up to 4000 VA (e.g. heaters), well visible signalization, noiseless	36
VS116U	1M-DIN	AC/DC 12..240 V	1x16 A changeover/ SPDT	●	●	●	as VS116K, but multivoltage supply coil	36
VS308K	1M-DIN	AC 230 and AC/DC 24 V	3x 8 A changeover/ TPDT	●	●	●	a "multiplication" of contacts, 3x changeover contact/ 3PDT only in 1-MODULE, well visible signalization, noiseless	36
VS308U	1M-DIN	AC/DC 12..240 V	3x 8 A changeover/ TPDT	●	●	●	as VS308K, but multivoltage supply coil	36
VS316/24	1M-DIN	AC/DC 24 V	3x16 A changeover/ TPDT	●	●	●	3x changeover contact in 1-MODULE, possibility of "multiplication" of contacts and in the same time possibility of switching high output, possibility of 3 phase switching	36
VS316/230	1M-DIN	AC 230 V	3x16 A changeover/ TPDT	●	●	●	as VS316/24, but AC 230 V	36
782L	PLUG-IN	AC 6-230 V, DC 6-110 V	4x6 A changeover/ 4PDT	●	x	x	compact small relay for installation into plug relay, basic version equipped by LED indication, detent and testing lever	38
750L	PLUG-IN	AC 6-230 V, DC 6-110 V	3x10 A changeover/ 3PDT	●	x	x	as 782L, but into 11-pin round socket, 3x changeover contact / 3PDT 10A/250 V	38

More about contact loadability on page 158.



Type	Current rating	Number of contacts	Design	Supply terminals
VS116K	16 A	1	DIN (1M)	A1 - A2 230 V AC / A1 - A3 24 V AC/DC
VS116U	16 A	1	DIN (1M)	A1 - A2 12- 240 V AC/DC
VS116B/230	16 A	1	BOX (MINI)	L-N 230 V AC
VS308K	8 A	3	DIN (1M)	A1 - A2 230 V AC / A1 - A3 24 V AC/DC
VS308U	8 A	3	DIN (1M)	A1 - A2 12 - 240 V AC/DC
VS316/24	16 A	3	DIN (1M)	A1 - A2 24 V AC/DC
VS316/230	16 A	3	DIN (1M)	A1 - A2 230 V AC

- Power relay used for switching larger load output, strengthen or „multiplying“ contacts of the existing device.
- Relays VS316/24, VS316/230 enable connection to a 3-phase circuit.
- In the design 1-MODULE , DIN rail mounting, output status indicated by high intensity LED with choice of LED color (red, green, yellow, blue or white LED*).
- VS116/B230 MINI, mounting in installation box or ceilings, enabling switching of lights, motors for blinds or awnings.
- For VS116/B230 status of output indicated by LED on front panel of device.

Technical parameters	VS116B/230	VS116K	VS116U	VS308K	VS308U	VS316/24	VS316/230
Supply terminals:	L - N			A1 - A2			
Voltage range:	AC 230 V / 50-60 Hz	AC 230 V / 50-60 Hz	AC/DC 12-240 V / 50-60 Hz	AC 230 V / 50-60 Hz	AC/DC 12-240 V / 50-60 Hz	AC/DC 24 V / 50-60 Hz	AC 230 V / 50-60 Hz
Burden (max.):	AC 7.5 VA / 1 W	AC 7.5 VA / 1 W	AC 0.7 - 3 VA / DC 0.5 - 1.7 W	AC 10.3 VA / 1.1 W	AC 0.7 - 3 VA / DC 0.5 - 1.7 W	1.6 VA / 1.2 W	2.5 VA
Supply terminals:	x	A1 - A3	x	A1 - A3		x	
Voltage range:	x	AC/DC 24 V (50-60 Hz)	x	AC/DC 24 V (50-60 Hz)		x	
Burden:	x	AC 1 VA / DC 1W	x	AC 1 VA / DC 1W		x	
Supply voltage tolerance:				-15%; +10%			
Max. dissipated power (Un + terminals):		4 W		3 W		8 W	6 W
Output							
Number of contacts:	1 x changeover/ SPDT (AgSnO ₂)			3 x changeover/TPDT (AgNi / Silver Alloy)		3 x changeover/ TPDT (AgSnO ₂)	
Current rating:	16 A / AC1			8 A / AC1		16 A / AC1	
Breaking capacity:	4000VA / AC1, 384W / DC			2000VA / AC1, 192W / DC		4000VA / AC1, 384W / DC	
Inrush current:	30 A / <3s			10 A / <3s		30 A / <3s	
Switching voltage:	250 V AC1 / 24 V DC						
Output indication:	red LED	high intensity of LED					
Mechanical life:			3x10 ⁷				1x10 ⁷
Electrical life (AC1):			0.7x10 ⁵				1x10 ⁵
Time between switching:			min. 2s			20 ms	50 ms
Other information							
Operating temperature:	-20.. +55 °C						
Storage temperature:	-30.. +70 °C						
Electrical strength:	4 kV (supply-output)						
Operating position:	any						
Mounting:	free at connecting wire	DIN rail EN 60715					
Protection degree:	IP30	IP40 from front panel / IP20 terminals					
Overvoltage category:	III.						
Pollution degree:	2						
Max. cable size (mm ²):	2x 0.75 mm ² (AWG 18), 3x 2.5 mm ² (AWG 10)			max. 1x 2.5 or 2x 1.5 max. 1x 2.5 (AWG 12)			
Dimensions:	49 x 49 x 21 mm (2" x 2" x 0.8")			90 x 17.6 x 64 mm (3.5" x 0.7" x 2.5")			
Weight:	48 g (1.7 oz.)	56 g (2 oz.)	59 g (2.1 oz.)	78 g (2.75 oz.)	80 g (2.8 oz.)	90 g (3.17 oz.)	93 g (3.3 oz.)
Standards:	EN 61810-1, EN 61010-1						

Symbol

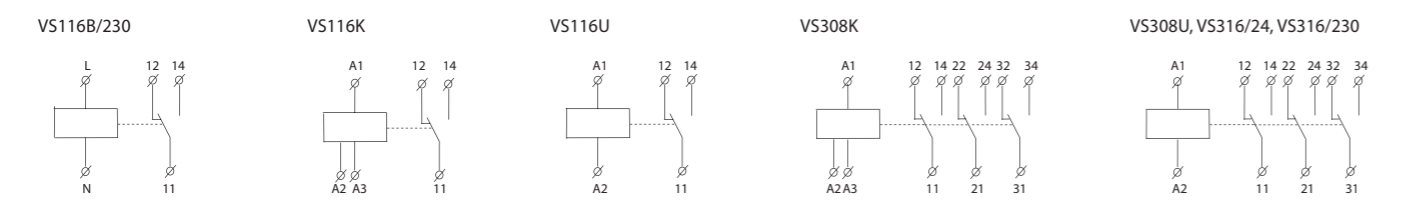

Description

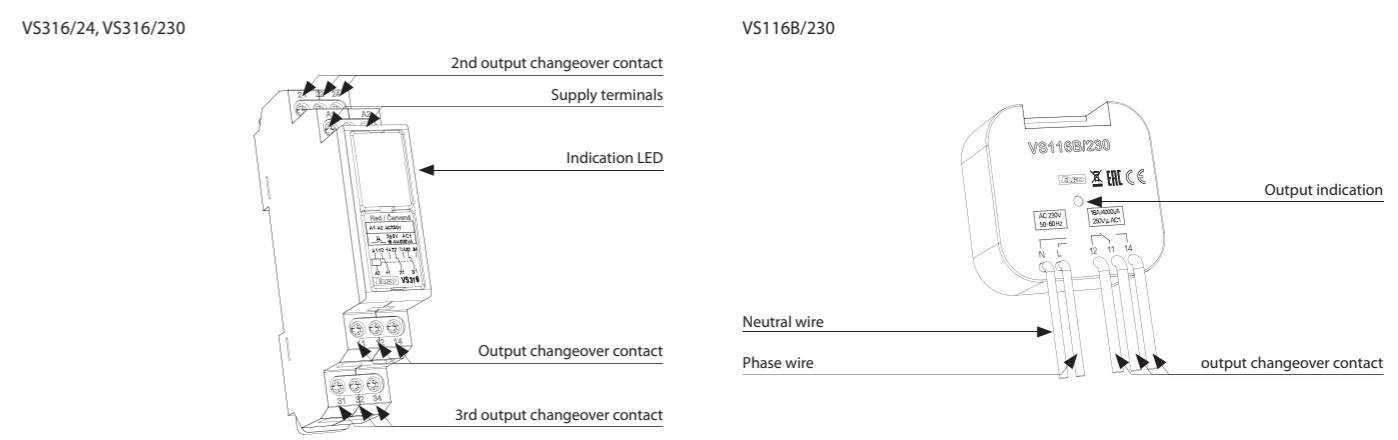
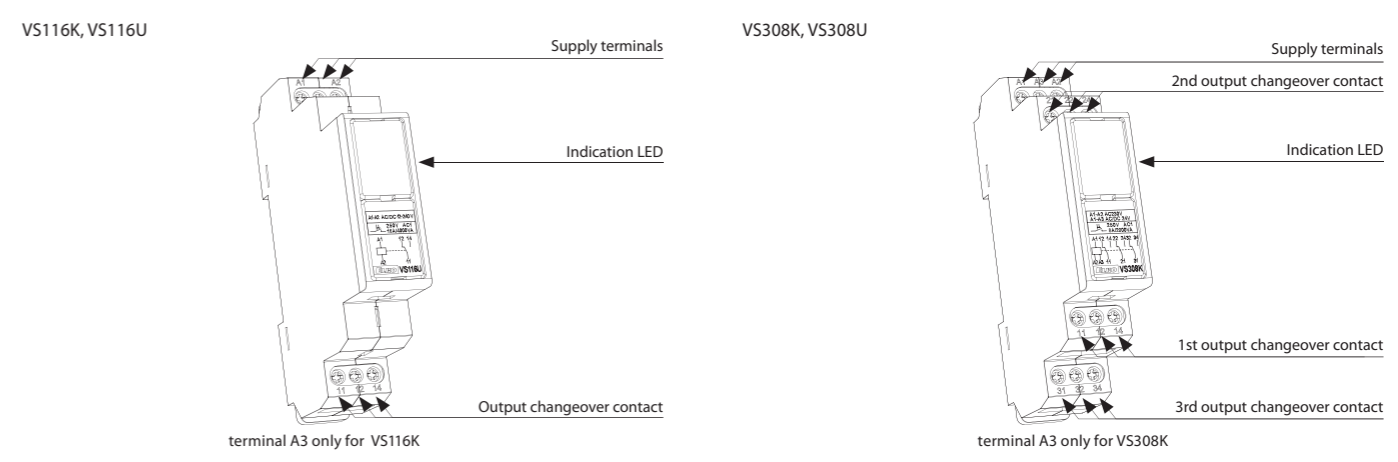

EAN codes

VS116B/230	8595188147545				
VS116K /red	8595188122597	VS308K /red	8595188122696	VS316 /24 red	8595188135771
VS116K /green	8595188122610	VS308K /green	8595188122719	VS316 /24 green	8595188136105
VS116K /yellow	8595188122580	VS308K /yellow	8595188122689	VS316 /24 yellow	8595188136129
VS116K /white	8595188122573	VS308K /white	8595188122672	VS316 /24 white	8595188136099
VS116K /blue	8595188122603	VS308K /blue	8595188122702	VS316 /24 blue	8595188136112
VS116U /red	8595188124607	VS308U /red	8595188130103	VS316 /230 red	8595188135559
VS116U /green	8595188136433	VS308U /green	8595188136440	VS316 /230 green	8595188136075
VS116U /yellow	8595188138499	VS308U /yellow	8595188138529	VS316 /230 yellow	8595188136082
VS116U /white	8595188138482	VS308U /white	8595188138512	VS316 /230 white	8595188136051
VS116U /blue	8595188138475	VS308U / blue	8595188138505	VS316 /230 blue	8595188136068

Notes

Max. time of changeover of contact is 10ms.

VS316/24 or VS316/230 enables switching of different phases or 3 phase voltage.

* possibility to choose blue, white and yellow color of LED for power relays line VS in case of minimal order quantity 100 pcs.



750L 782L

- Used for switching a higher power (load) than the capacity of switched element = amplifier.
- For auxiliary lighting control, signalization, the relay interlockings, boilers, heaters.
- 3x changeover contacts of 10 A (AgNi) for 750L.
- 4x changeover contacts of 6 A (AgNi) for 782L.
- Recommended sockets - ES-11 socket for 750L, ES-15/4N socket for 782L.

Technical parameters	750L	782L
Contacts		
Number of switching contacts:	3	4
Contact material:	AgNi	AgNi
Rated voltage:	AC 250 V/440 V (50 - 60 Hz)	AC 250 V/250 V (50 - 60 Hz)
Rated current:	10 A	6 A
Peak current:	20 A	12 A
Switching capacity (AC1):	10A/250A	6A/250A
Switching capacity (AC3):	370W	125W
Switching capacity (AC15):	(single-phase motor) 3A/120 V/1.5A/240 V	(single-phase motor) 1.5A/120 V/0.75A/240 V
Switching capacity (DC1):	10 A / 24 V DC	6 A / 24 V DC
Switching capacity (DC13):	0.22 A / 120 V 0.1 A/250 V	0.22 A / 120 V 0.1 A/250 V
Minimum switching voltage / current:	5 mA / 5 V	5 mA / 5 V
Coil		
	1.5 W / DC	1.5 W / DC
Rated Voltage (DC):	12, 24, 48, 60, 110, 120, 220 V	5, 6, 12, 24, 60, 80, 125, 220 V
Rated voltage (AC, 50-60 Hz):	12, 24, 48, 60, 115, 120, 230, 240 V	12, 24, 42, 60, 80, 110, 115, 127, 230, 240 V
Rated power (AC / DC):	AC 2.8 VA (50 Hz) / 2.5 VA (60 Hz) / DC 1.5 W	AC 1.6 VA / DC 0.9 W
Tolerance of supply voltage:	-20 / +10 %	-20 / +10 %
Isolating data		
Rated insulation voltage (AC):	2500 V	2500 V
Dielectric strength (AC)		
Coil - contact:	2500 V	2500 V
Contact - contact:	1500 V	1500 V
Isolating resistance at 500 V DC:	10 ⁷ Ω	10 ⁷ Ω
Distance contact - coil		
Air:	≥ 3 mm	≥ 1.6 mm
Surface:	≥ 4.2 mm	≥ 3.2 mm
General information		
Mechanical life:	≥ 2x10 ⁷	1x10 ⁷
Electrical life (AC1):	≥ 2x10 ⁵ 10 A / 250 V AC	≥ 10 ⁵ 6 A / 250 V AC
Max. switching frequency		
At rated load:	1200 cycles / hrs	1200 cycles / hrs
Without load:	12000 cycles / hrs	18000 cycles / hrs
Pick-up time / returning contact:	max. 12 / 10 ms	max. 10 / 8 ms
Working temperature:	-40.. +55 °C (-40 to 131 °F)	-40.. +55 °C (-40 to 131 °F)
Storage temperature:	-40 .. +85 °C (-40 to 185 °F)	-40.. +85 °C (-40 to 185 °F)
Protection:	IP40 from the front panel	IP40 from the front panel
Dimensions:	35 x 35 x 54.4 mm	27.5 x 21.2 x 35.6 mm
Weight:	84 g (3 oz)	31 g (1.1 oz)
Standards:	EN 60947-4-1, EN 60947-5-1	EN 61810-1, EN 60255-1-00, EN 61810-7

Coil data for 750L

Product Type	Voltage [V]	Resistance [Ω]
AC voltage		
5012	AC 12	18.5
5024	AC 24	75
5048	AC 48	305
5060	AC 60	475
5115	AC 115	1 840
5120	AC 120	1 910
5230	AC 230	7 080
5240	AC 240	7 760
DC voltage		
1012	DC 12	110
1024	DC 24	430
1048	DC 48	1 750
1060	DC 60	2 700
1110	DC 110	9 200
1120	DC 120	11 000
1220	DC 220	37 000

Coil data for 782L

Product Type	Voltage [V]	Resistance [Ω]
AC voltage		
5006	AC 6	9.8
5012	AC 12	39.5
5024	AC 24	158
5042	AC 42	470
5060	AC 60	930
5080	AC 80	1 720
5110	AC 110	3 450
5115	AC 115	3 610
5127	AC 127	4 000
5230	AC 230	16 100
5240	AC 240	16 800
DC voltage		
1005	DC 5	28
1006	DC 6	40
1012	DC 12	160
1024	DC 24	640
1060	DC 60	4 000
1080	DC 80	7 100
1125	DC 125	16 000
1220	DC 220	15 400

Connection

750L

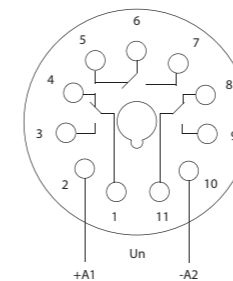

782L

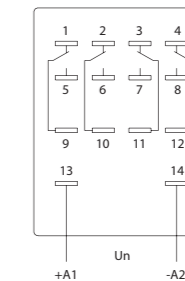

Socket

ES-11 for 750 L

Max. Current: 10A
Weight: 60 g (2.1 oz.)
Mounting on DIN rail
Designed for 3- relay contacts



ES-15/4N - for 782L

Max. Current: 12A
Weight: 59 g (2 oz.)
Mounting on DIN rail
Designed for 4- relay contacts



EAN code

750L/110 V DC	8595188129992	782L/12V AC	8595188119085	ES-15/4N	8595188119245
750L/120 V AC	8595188130028	782L/12V DC	8595188119030	ES-11	8595188129879
750L/12V AC	8595188130011	782L/230 V AC	8595188119115	ES8	8595188136167
750L/12V DC	8595188129978	782L/24V AC	8595188119092	Clip to relay 750L	8595188119283
750L/230 V AC	8595188119221	782L/24V DC	8595188119047	Clip to relay 782L	8595188119276
750L/24V AC	8595188119207	782L/6V DC	8595188129909		
750L/24V DC	8595188125147				
750L/48V DC	8595188129985				

Accessories

To ES-11 socket - for 750L

Clip to relay 750L: 16-1351



To ES-15/4N socket - for 782L

Swivel label - TR1
The LED module, the protective diode and R/C member can be assigned into the slot.



DIMMERS

MODULAR

R, L, LED¹



DIM-2

Staircase switch with gradual dimming up/down, level and time of illumination, all values are adjustable.
R = 10 -500 VA
L = 10 -250 VA.



DIM-5

Control by a button/ buttons (connected in parallel), short pressing ON/OFF, long pressing regulates brightness, memory storing.
R = 10 -500 VA
L = 10 -250 VA.

R, L, C, LED²



DIM-14

As DIM-5 but dims all types of loads, in-built protection against temperature and current overload, electronic fuse.
R = 500 VA
L = 500 VA
C = 500 VA.



DIM-15

Designated for dimming of: dimmable energy saving fluorescent lamps, LED lamps.
R,L,C, - resistive, inductive and capacitive loads.

R, L, C, ESL, LED²



LIC-1

Intensity controller for maintaining the constant illumination level. Dimmable energy saving fluorescent lamps, LED lamps.
R,L,C, - resistive, inductive and capacitive loads.



LIC-2

Serves as control unit for dimmers or electronic ballasts with analog control 0-10 V / 1-10 V.

R, L, C, LED²

MODULAR



DIM-6

Power dimming to 2kW. Can be controlled by button, external potentiometer, 0-10 V (1-10 V) system INELS.
R = 2000 VA
L = 2000 VA
C = 2000 VA.



DIM6-3M-P

DIM6-3M-P is a power module expansion unit for DIM-6. It cannot be operated independently.
R = 1000 VA
L = 1000 VA
C = 1000 VA.

R, L, LED¹

MINI



SMR-S

As DIM-5, but for mounting under a wall-switch into an installation box KU-68 (or the similar), 3 wire connection (without neutral).
R = 10-300 VA
L = 10-150 VA.



SMR-U

As DIM-14, but for mounting under a wall-switch into an installation box KU-68 (or the similar).
R = 1000 VA
L = 1000 VA
C = 1000 VA.

R, L, C, ESL, LED²



SMR-M

For mounting under a wall-switch into an installation box KU-68 (or similar). Dimmable energy saving fluorescent lamps, LED lamps.
R,L,C, - resistive, inductive and capacitive loads.

Overview table

Type	Design	Supply voltage	Type of dimmed load						Output unit	Output			Method of phase regulation		Control principal 0-10 V / 1-10V	Designation	Catalogue page
			R resistive (el. bulbs, halogen lights)	L inductive (wound transformers)	C capacitive (electronic transformers)	ESL energy saving fluorescent lamps	LED ^{1,2} LED lamps	Rated load			ON-DIMMER	OFF-DIMMER					
								R		L			C				
DIM-2	1M-DIN	AC 230 V	●	●	x	x	●	triac	10-500 VA*	10-250 VA	x	●	x	x	Stairway automaton with progressive illumination on / off, adjustable rise time, delay, deceleration, maximum brightness. Dimmer R, L, LED ¹ .	42	
DIM-5	1M-DIN	AC 230 V	●	●	x	x	●	triac	10-500 VA*	10-250 VA	x	●	x	x	Universal dimmer R, L, LED ¹ , button control.	43	
DIM-14	1M-DIN	AC 230 V	●	●	●	x	●	2x MOSFET	500 VA*	500 VA*	500 VA*	●	●	x	Universal dimmer R, C, L, LED ² , button control, automatic switching of the dimming mode according to the connected load	48	
DIM-15	1M-DIN	AC 230 V	●	●	●	●	●	2x MOSFET	300 VA	300 VA	300 VA	●	●	x	Universal dimmer R, C, L, ESL, LED ² , button control,	46	
DIM-6	6M-DIN	AC 230 V	●	●	●	x	●	4x MOSFET	2 000 VA*	2 000 VA*	2 000 VA*	●	●	●	Universal dimmer 2kW R, C, L, LED ² , power expandable, pushbutton control / 0-10V / 1-10V / potentiometer / INELS bus.	44	
DIM6-3M-P	3M-DIN	AC 230 V	●	●	●	x	●	2x MOSFET	1 000 VA*	1 000 VA*	1 000 VA*	●	●	x	Expansion power module 1kW to DIM-6 dimmer.	45	
SMR-S	BOX	AC 230 V	●	●	x	x	●	triac	10-300 VA*	10-150 VA	x	●	x	x	Like DIM-5, but for mounting under the push-button into the installation box (e.g. KU-68).	49	
SMR-U	BOX	AC 230 V	●	●	●	x	●	2x MOSFET	500 VA*	500 VA*	500 VA*	●	●	x	Like DIM-14, but for mounting under the push-button into the installation box (e.g. KU-68).	49	
SMR-M	BOX	AC 230 V	●	●	●	●	●	2x MOSFET	160 VA	160 VA	160 VA	●	●	x	Like DIM-15, but for mounting under the push-button into the installation box (e.g. KU-68).	46	
LIC-1	1M-DIN	AC 230 V	●	●	●	●	●	2x MOSFET	300 VA*	300 VA*	300 VA*	●	●	x	Universal dimmer R, C, L, ESL, LED ² , button control, constant light level control.	50	
LIC-2	1M-DIN	AC 100 -250 V	x	x	x	x	x	x	x	x	x	x	x	●	Controller for dimmers or electronic ballasts with 0-10 V / 1-10V control, button control, constant light level control.	51	

* with load over 300 VA is necessary to ensure sufficient cooling

Key to symbols

TYPE OF LOAD (symbols)	bulbs, halogen lamps	low-voltage el.bulbs 12/24V wound transformers	low-voltage el.bulbs 12/24V electronic transformers	ESL dimmable compact fluorescent lamps	Dimmable LED bulbs
	R	L	C	ESL	LED ^{1,2}

Demonstrated symbols are informative

Expansatory:

- Dimmer with designated load:
- R - resistive
- L - inductive
- C - capacitive
- ESL - energy saving bulbs
- LED¹ - dimmable LED bulbs, designed for dimmers with phase-controlled rising edge (triac dimmers)
- LED² - dimmable LED bulbs designed for dimmers with phase or phase-to-phase phase control (dimmers with MOSFET)

IPxx protection - under normal conditions: normal conditions are understood as such conditions of operating an electrical device, installation and power supply network for which the entire device is designed, produced and installed. Upon these normal conditions of use and upon normal maintenance, all protective devices must be effective throughout the entire expected service life of the product.

Recommendation for mounting modular dimmers: leave a gap of min. 0.5 module (approx. 9 mm / 0.4") on side of the device to ensure better cooling of the device.



EAN code
DIM-2 /230 V: 8595188112475
DIM-2-1h /230 V: 8595188135740

Technical parameters DIM-2

Supply terminals:	A1 - A2
Voltage range:	AC 230 V / 50 Hz
Burden (unloaded):	max. 8 VA / 0.6 W
Max. dissipated power:	1.5 W
Supply voltage tolerance:	-15 %; +10 %
Supply indication:	green LED
Time setting by:	potentiometers
Time deviation:	10 % - mechanical setting
Repeat accuracy:	5 % - set value stability
Temperature coefficient:	0.01 % / °C, at = 20 °C (0.01 % / °F, at = 68 °F)
Recovery time:	max. 80 ms

Controlling T1 (button)

Terminals:	T1 - A1
Voltage:	AC 230 V
Power on control input:	max. 1.5 VA
Impulse length:	min.100 ms / max. unlimited
Glow-lamps:	Yes
Max. amount of glow lamps connected to controlling input:	230 V - max. amount 50 pcs (measured with glow lamp 0.68 mA / 230 V AC)

Controlling T2 (switch)

Terminals:	T2 - A1
Voltage:	AC 230 V
Power on control input:	0.1 VA
Impulse length:	min.100 ms / max. unlimited

Output

Current rating:	2 A
Resistance load:	10 - 500 VA
Inductive load:	10 - 250 VA

Other information

Operating temperature:	-20 °C to +55 °C (-4 °F to 131 °F)
Storage temperature:	-30 °C to +70 °C (-22 °F to 158 °F)
Operating position:	any
Mounting:	DIN rail EN 60715
Protection degree:	IP40 from front panel / IP10 terminals
Overvoltage category:	III.
Pollution degree:	2
Max. cable size (mm ²):	solid wire max. 2x 2.5 or 1x 4 / with sleeve max. 1x 2.5 or 2x 1.5 (AWG 12)
Dimensions:	90 x 17.6 x 64 mm (3.5" x 0.7" x 2.5")
Weight:	64 g (2.3 oz.)
Standards:	EN 60669-2-1, EN 61010-1

Symbol

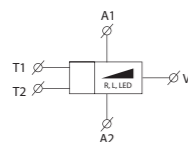

- Designated for dimming el. bulbs, halogen lights and halogen lights with winding transformers and Dimmable LED¹.
 - Intelligent control of halogen lights, function of gradual switching on and dimming.
 - Controlling inputs for push button and switch.
 - Values are set by potentiometers on front panel of the product, adjustable:
 - maximum dim-up
 - speed (fluency) of dim-up
 - speed (fluency) of dim-down
 - time for which a light is on with maximum dim-up.
 - Output without contact: 1x triac.
 - Clamp terminals.
 - Parallel connection of controlling pushbuttons is possible.
 - Protection against over-temperature inside the product - switches output off + signalizes overheating by LED flashing.
 - Note: possibility of start and finish adjustment up on 1 hour, device has description DIM-2 1h.
 - 1-MODULE, DIN rail mounting.
- ¹ For more information, see page 41

Description

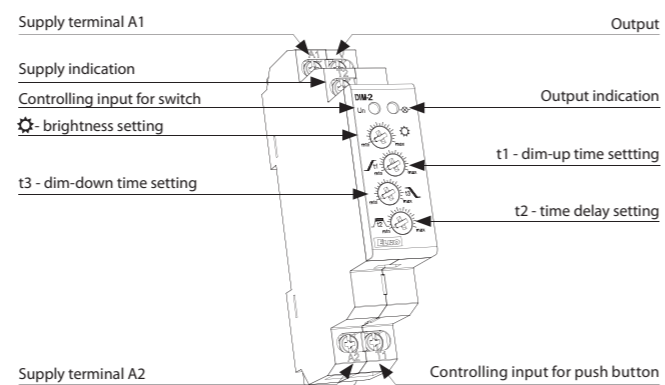

Recommendation for mounting: leave a gap of min. 0.5 module (approx. 9 mm) on side of the device to ensure better cooling of the device.

Connection

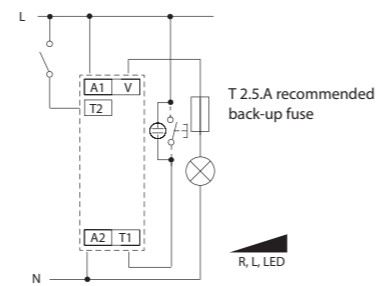

Function

Controlled via input T1(button)

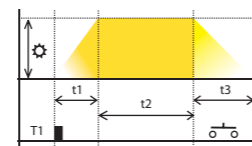

Dim-up delay-down is started by a button. Cycle extension - by re-pressing button (during the cycle).

Controlled via input T2 (switch)

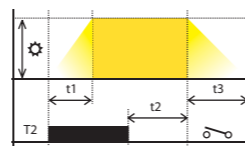

The switch starts the cycle and it stops on max.set brightness. After the switch is off, the cycle will continue until completed.

Legend:
 ⚙ Brightness: 10 - 100 %
 t1 Dim-up time: 1 - 40 s
 t2 Time delay: 0 s - 20 min
 t3 Dim-down time: 1 - 40 s



EAN code
DIM-5 /230V: 8595188115612

Technical parameters DIM-5

Supply terminals:	A1 - A2
Voltage range:	AC 230 V / 50 Hz
Burden (unloaded):	max. 7.5 VA / 0.6 W
Max. dissipated power:	1 W
Supply voltage tolerance:	-15 %; +10 %
Supply indication:	green LED

Controlling

Control terminals:	T - A1
Control voltage:	AC 230 V
Power control input:	max. 1.5 VA
Impulse length:	min. 80 ms / max. unlimited
Glow-lamps:	Yes
Max. amount of glow lamps connected to controlling input:	230 V - max. amount 50 pcs (measured with glow lamp 0.68 mA / 230 V AC)

Output

Current rating:	2 A
Resistance load:	10 - 500 VA
Inductive load:	10 - 250 VA
Output indication:	red LED

Other information

Operating temperature:	-20 °C to +55 °C (-4 °F to 131 °F)
Storage temperature:	-30 °C to +70 °C (-22 °F to 158 °F)
Operating position:	any
Mounting:	DIN rail EN 60715
Protection degree:	IP40 from front panel / IP10 terminals
Overvoltage category:	III.
Pollution degree:	2
Max. cable size (mm ²):	solid wire max. 2x 2.5 or 1x 4, with sleeve max. 1x 2.5 or 2x 1.5 (AWG 12)
Dimensions:	90 x 17.6 x 64 mm (3.5" x 0.7" x 2.5")
Weight:	58 g (2 oz.)
Standards:	EN 60669-2-1, EN 61010-1

Recommendation for mounting: leave a gap of min. 0.5 module (approx. 9 mm / 0.4") on side of the device to ensure better cooling of the device.

- Designated for dimming el. bulbs, halogen lights and halogen lights with winding transformers and Dimmable LED¹.
- Short press turns light on/off, longer press (> 0.5 s) provides dim up / dim down.
- When switched off, brightness level is stored in a memory and when ON again it restores last brightness level.
- Voltage range: AC 230 V.
- Contactless output.
- LED output indication (with any level of brightness).
- Possibility to connect control buttons in parallel.
- 1-MODULE, DIN rail mounting.
- Clamp terminals.
- Protection against over-heating inside the product - switches output off + signalizes overheating by LED flashing.

¹ For more information, see page 41

Description

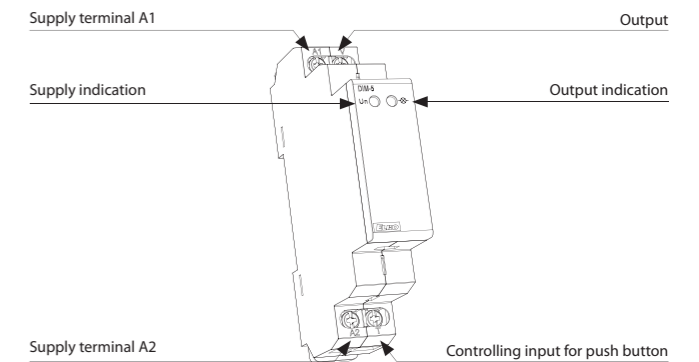

Connection

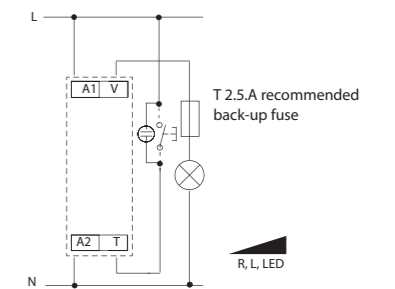

Function

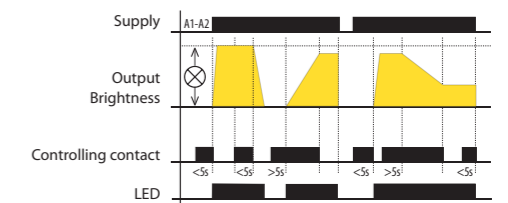

Symbol

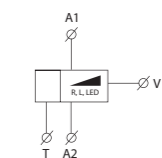



EAN code
DIM-6 / 230 V: 8595188136914

Technical parameters	DIM-6
Supply terminals:	L, N
Supply voltage:	AC 230 V / 50 Hz
Burden (unloaded):	max. 4 VA / 3.2 W
Max. dissipated power:	6 W
Tolerance of voltage range:	-15 %; +10 %
Max. output power:	max. 2 000 VA
Module extendable:	to 10 000 VA
Galvanic separation of BUS and power output:	Yes
Isul. volt. between outputs and inner circuits:	3.75 kV, SELV according to EN 60950
Control - button type	
Control voltage:	AC 12 - 240 V
Control terminals:	S - S, galvanically separated
Power of control input:	AC 0.53VA (AC 230 V), AC 0.025-0.2VA (AC 12-240 V)
Length of control impulse:	min. 25 ms / max. unlimited
Recovery time:	max. 150 ms
Connection of glow lamps:	No
Control 0(1)-10 V	
Control terminals:	0(1)-10 V, GND
Control voltage:	0-10 V or 1-10 V
Min. current of control input:	1 mA
BUS control:	
Control terminals:	BUS+, BUS-
BUS voltage:	27 V DC
Current of control input:	5 mA
Indication of data transmission:	yellow LED
Output	
Contactless:	4 x MOSFET
Current rating:	10 A
Resistive load:	2 000 VA*
Inductive load:	2 000 VA*
Capacitive load:	2 000 VA*
Indication of output state:	yellow LED, according to load type
Other information	
Operating temperature:	-20 °C to +35 °C (-4 °F to 95 °F)
Storing temperature:	-30 °C to +70 °C (-22 °F to 158 °F)
Operating position:	vertical
Mounting:	DIN rail EN 60715
Protection degree:	IP40 from front panel
Purpose of control device:	operative control device
Construction of control device:	individual control device
Char. of automatic operation:	1.B.E
Heat and fire resistance cat.:	FR-0
Anti-stroke category (immunity):	class 2
Rated impulse voltage:	2.5 kV
Overvoltage category:	III.
Pollution level:	2
Profile of connecting wires (mm ²)	
- output part:	max.1x2.5, max. 2x1.5/ with sleeve max. 1x1.5 (AWG 12)
- control part:	max.1x2.5, max. 2x1.5/ with sleeve max. 1x2.5 (AWG 12)
Dimensions:	90 x 105 x 65 mm (3.5" x 4.1" x 2.6")
Weight:	392 g (13.8 oz.)
Standards:	EN 60669-2-1, EN 61010, EN 55014

- Designed for dimming of incandescent bulbs and halogen lights with wound or electronic transformer and Dimmable LED².
- DIM-6 control options:
 - button (parallel button connection)
 - external potentiometer
 - analog signal 0-10 V (1-10 V)
 - iNELS BUS system.
- The DIM-6 can connect up to 8 pieces of DIM6-3M-P and control up to 10.000 VA.
- Electronic overcurrent protection, overvoltage and short-circuit protection.
- Protection against over-heating inside device - switch off output + signalize overheat by flashing red LED.
- 6-MODULE version, DIN rail mounting.
- ² For more information, see page 41

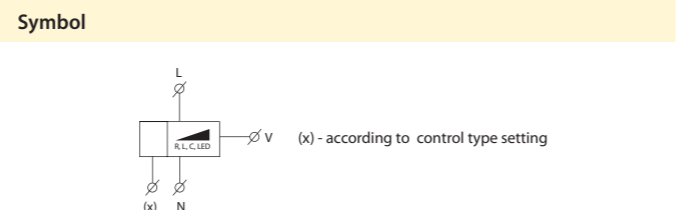
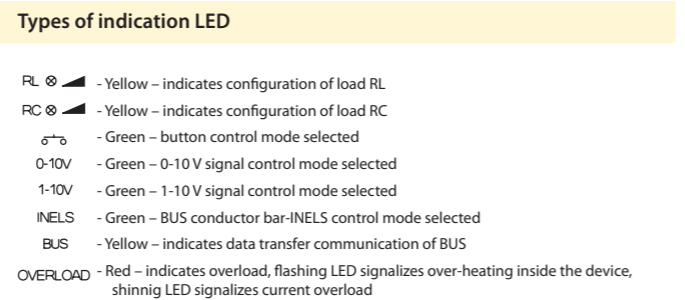
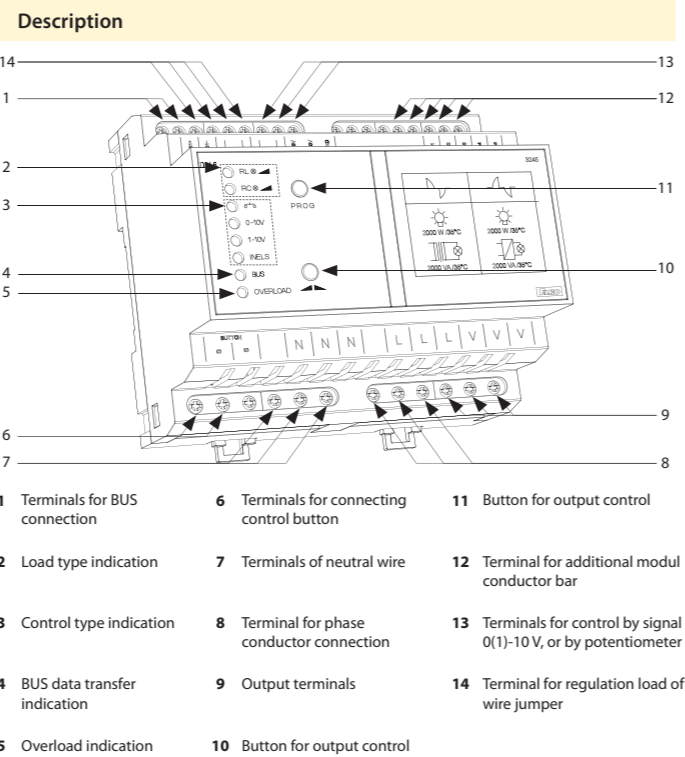

* Warning: it is not allowed to connect inductive and capacitive loads at the same time.



EAN code
DIM6-3M-P: 8595188139106

Technical parameters	DIM6-3M-P
Load:	max. 1 000 VA
Max. dissipated power:	6 W
Output	
Contactless:	2 x MOSFET
Current rating:	5 A
Resistive load:	1 000 VA*
Inductive load:	1 000 VA*
Load capacity:	1 000 VA*
Other information	
Operating temperature:	-20 °C to +35 °C (-4 °F to 95 °F)
Storing temperature:	-30 °C to +70 °C (-22 °F to 158 °F)
Operating position:	vertical
Mounting:	DIN rail EN 60715
Protection degree:	IP40 from front panel
Controlling device purpose:	operating control device
Controlling device construction:	additional control device
Automatic operating char.:	1.B.E
Heat and fire resistance category:	FR-0
Immunity category:	class 2
Rated impuls voltage:	2.5 kV
Overvoltage category:	III.
Pollution level:	2
Profile of connecting wires (mm ²)	
- output part:	max.1x2.5, max. 2x1.5 / with sleeve max. 1x1.5 (AWG 12)
- control part:	max.1x2.5, max. 2x1.5 /with sleeve max. 1x2.5 (AWG 12)
Size:	90 x 52 x 65 mm (3.5" x 2" x 2.6")
Weight:	130 g (4.5 oz.)
Standards:	EN 60669-2-1, EN 61010, EN 55014

Connection

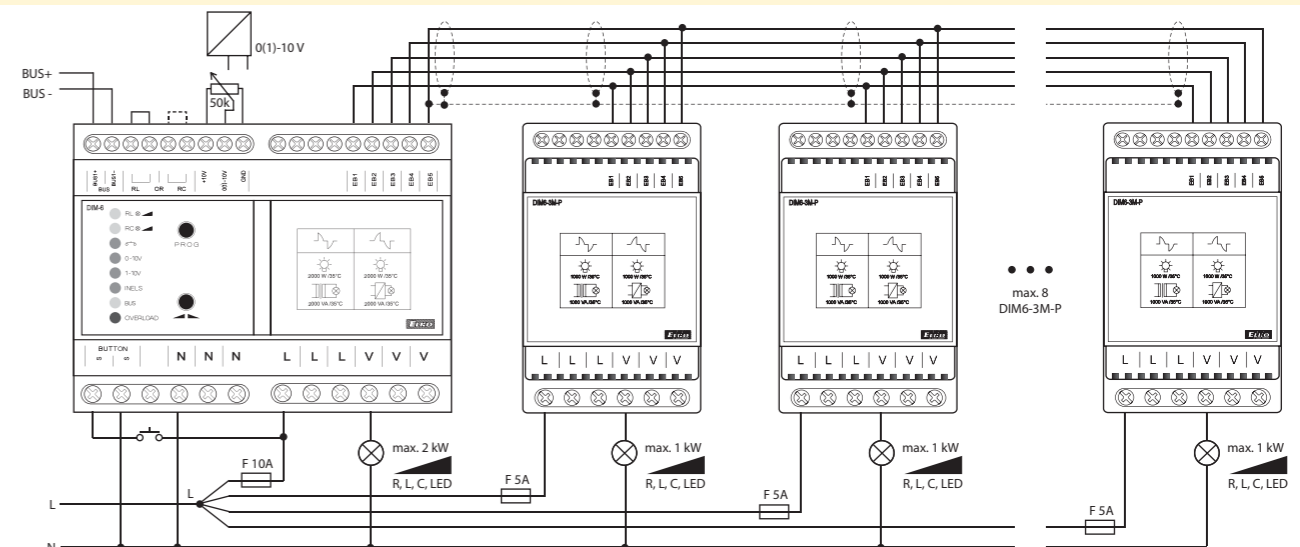

A quick fuse corresponding to the power of each module must be included in the L supply for each module.

- Expanding power module only for use in combination with DIM-6.
- DIM6-3M-P provides power increase (of about 1 000 VA) of load connected to DIM-6 (it means: 2 000 VA (DIM-6) + 1 000 VA (DIM6-3M-P) = 3 000 VA).
- The DIM-6 can connect up to 8 pieces of DIM6-3M-P and control up to 10.000 VA (the load must be divided into individual power blocks so that their maximum power is not exceeded).
- Attention-device has to be protected by circuit breaker accordant to the load connected to device.
- DIM-6 in installation is cooled by natural air flow. If the natural air flow access is reduced, cooling has to be provided by ventilator. Rated operating temperature is 35 °C / 95 °F.
- If there are several DIM6-3M-P connected to DIM-6, the distance between them has to be min. 2 cm / 0.8".
- Max. length of BUS EB is 1 m / 39.4" and the connection has to be realized by shielded cable.

Device description

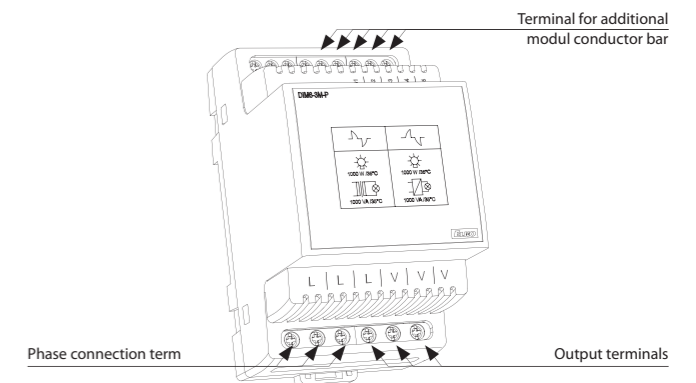

Note

The DIM-6 dimmer (L, V) terminals and the DIM6-3M-P expansion module are three-fold for easier multi-part loads.

* Warning: it is not allowed to connect loads of inductive and capacitive character at the same time.

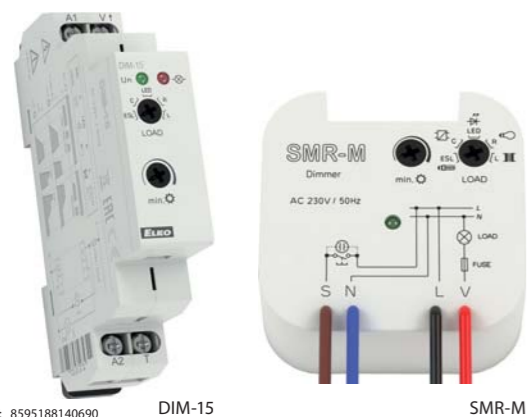

EAN code
DIM-15/230 V: 8595188140690
SMR-M: 8595188143776

Technical parameters	DIM-15	SMR-M
Supply terminals:	A1 - A2	x
Voltage range:	x	4-wire, with neutral
Operating range:	AC 230 V / 50 Hz	
Burden (unloaded):	max. 2 VA / 0.55 W	max. 0.66 VA / 0.55 W
Max. dissipated power:	2 W	3 W
Supply voltage tolerance:	-15 %; +10 %	
Supply indication:	green LED	
Control		
Control terminals:	A1 - T	x
Control wire:	x	L - S
Control voltage:	AC 230 V	
Control input power:	AC 0.3 - 0.6 VA	
Control impulse lenght:	min. 80 ms / max. unlimited	
Glow tubes connection:	Yes	
Max. amount of glow lamps connected to controlling input:	max. 15 pcs (measured with glow lamp 0.68 mA / 230 V AC)	max. 10 pcs (measured with glow lamp 0.68 mA / 230 V AC)
Output		
Contactless:	2 x MOSFET	
Load:	300 W (at cos φ = 1)*	160 W (at cos φ = 1)*
Output status indication:	red LED	x
Other information		
Operating temperature:	-20 °C to +35 °C (-4 °F to 95 °F)	
Storing temperature:	-20 °C to +60 °C (-4 °F to 140 °F)	
Operating position:	any	
Mounting:	DIN rail EN 60715	free at connecting wires
Protection degree:	IP40 from front panel / IP10 clips	IP 30 in standard conditions**
Overvoltage category:	III.	
Pollution level:	2	
Terminal wire capacity (mm ²):	max. 2x2.5, max. 1x4 with sleeve max. 1x2.5, max. 2x1.5 (AWG 12)	x
Connection wires (cross-section / lenght):	x	CY, 0.75 mm ² (AWG 18) / 90 mm (3.5")
Dimensions:	90 x 17.6 x 64 mm	49 x 49 x 21 mm
Weight:	58 g (2 oz.)	33 g (1.2 oz.)
Standards:	EN 60669-2-1, EN 61010-1	

* Due to a large number of light source types, the maximum load depends on the internal construction of dimmable light sources and their power factor cos φ. The power factor of dimmable LEDs and ESL bulbs ranges from cos φ = 0.95 to 0.4. An approximate value of maximum load may be obtained by multiplying the load capacity of the dimmer by the power factor of the connected light source.
** For more information see page 41.

Warning: it is not allowed to connect inductive and capacitive loads at the same time.

- Designed for dimming of incandescent bulbs and halogen lights with wound or electronic transformer, dimmable light bulbs and dimmable LED².
- Enables gradual setting of luminance by push-button (non-detent) or parallel buttons.
- Returns to last state upon re-energization.
- Type of light source is set by switch-over on the front panel of device.
- Min. luminance, set by potentiometer on the front panel, eliminates flashing of light sources.

DIM-15

- Output status is indicated by red LED:
 - shines when output is active.
 - flashes while heating overload, at the same time output is disconnected.
- 1-MODULE version, DIN rail mounting, saddle terminals.

SMR-M

- Button-controlled dimmer intended to be installed in an installation box into the existing electrical wiring.
- Protection against excessive temperature inside the device - switches off the output.

² For more information, see page 41

Connection

DIM-15

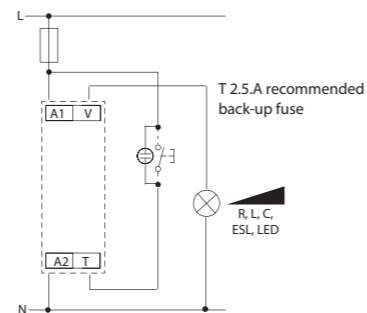

SMR-M

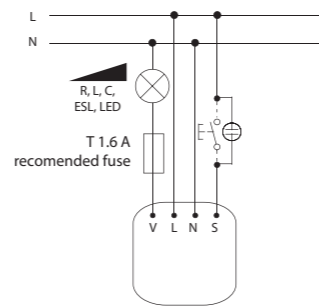

Symbol

DIM-15 (SMR-M)

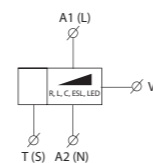

Light source type setting

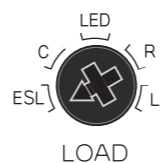

Device description

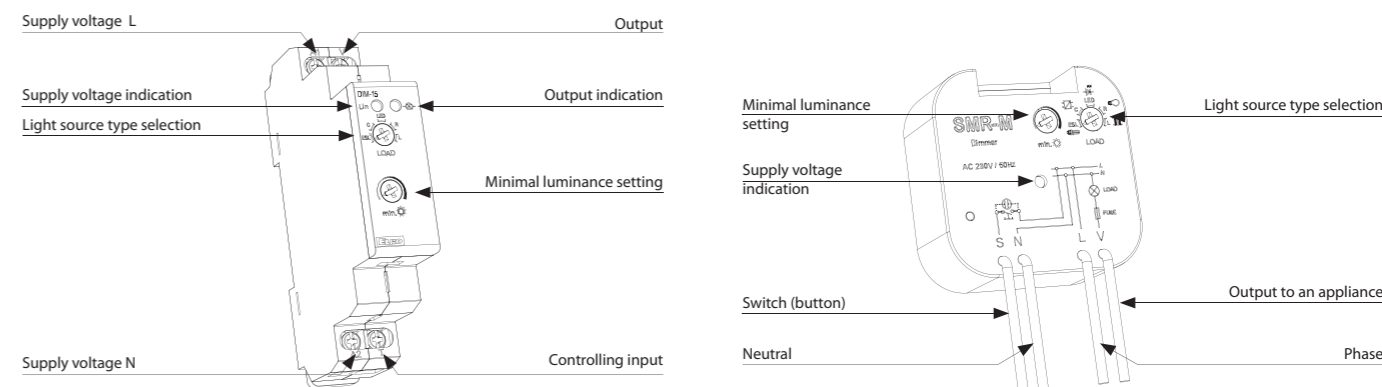

Functions and controlling

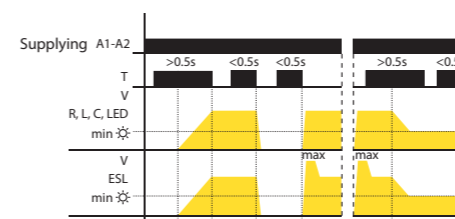

- short button press (<0.5s) turns the light off or on
 - long press (>0.5s) enables slight regulation of light intensity
 - setting of minimal luminance is possible only during decreasing of luminance by long button press
 - setting of minimal luminance by saving fluorescent lamps serves for harmonizing of lowest light intensity prior its unprompted switching off
- Luminance setting:**
LED, R, L, C:
- if the light is turned off, short press (<0.5s) switches the light onto last set luminance level
- ESL:**
- when light is off, short impulse turns lamp on and then luminance is decreased to set level

Connection example

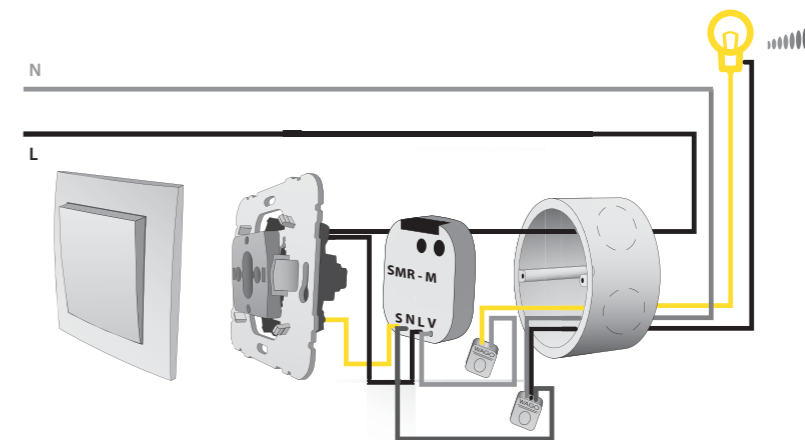

Additional information

- it is not possible to dim energy-saving lamps without marking: dimmable
 - an incorrect setting of light source has effect only on dimming range, it means neither dimmer or load get damaged
 - max. number of dimmable light sources depends on their internal structure
 - it is not recommended to connect light sources with different types and brands, to one dimmer
- list of dimmable sources on page 161



EAN code
DIM-14 /230 V: 8595188135955

Technical parameters	DIM-14
Supply terminals:	A1 - A2
Voltage range:	AC 230 V / 50 Hz
Burden (unloaded):	max. 11 VA / 1 W
Max. dissipated power:	1.5 W
Supply voltage tolerance:	-15 %; +10 %
Indication output:	green LED
Controlling	
Control terminals:	A1 - T
Control voltage:	AC 230 V
Power control input:	AC 0.3-0.6 VA
Impulse length:	min. 80 ms / max. unlimited
Glow-lamps:	Yes
Max. amount of glow lamps connected to controlling input:	230 V - max. amount 20 pcs (measured with glow lamp 0.68 mA / 230 V AC)
Output	
Contactless:	2 x MOSFET
Current rating:	2 A
Resistance load:	500 VA*
Inductive load:	500 VA*
Capacitive load:	500 VA*
Output state indication:	red LED
Other information	
Operating temperature:	-20 °C to +35 °C (-4 °F to 95 °F)
Storage temperature:	-20 °C to +60 °C (-4 °F to 140 °F)
Operating position:	any
Mounting:	DIN rail EN 60715
Protection degree:	IP40 from front panel / IP10 terminals
Overvoltage category:	III.
Pollution degree:	2
Max. cable size (mm ²):	solid wire max. 2x 2.5 or 1x 4 with sleeve max. 1x 2.5 or 2x 1.5 (AWG 12)
Dimensions:	90 x 17.6 x 64 mm (3.5" x 0.7" x 2.5")
Weight:	61 g (2 oz.)
Standards:	EN 60669-2-1, EN 61010-1

* When load is above 300 VA it is necessary to ensure sufficient cooling.

Recommendation for mounting: leave a gap of min. 0.5 module (approx. 9 mm / 0.4") on side of the device to ensure better cooling of the device.

Warning for DIM-14: it is not allowed to connect together loads of inductive and capacitive type in the same time.

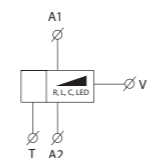

- designated for dimming of el. bulbs and halogen lights with wound or electronic transformer and Dimmable LED².
- for switching and dimming of lights, control inputs for a button
- short pressing switches ON/OFF, longer pressing (> 0.5 s) enables gradual light intensity setting
- when switched off, brightness level is stored in a memory and when switched on again this last brightness level is restored
- supply voltage: AC 230 V
- output without contacts: 2x MOSFET
- LED output indication (with any level of brightness) possibility of parallel connection of control buttons
- Electronic overvoltage protection.
- Protection against over-heating inside the device - output off.
- Resistive, inductive or capacitive load, up to 500 W.
- 1-MODULE, DIN rail mounting.

² For more information, see page 41

Description

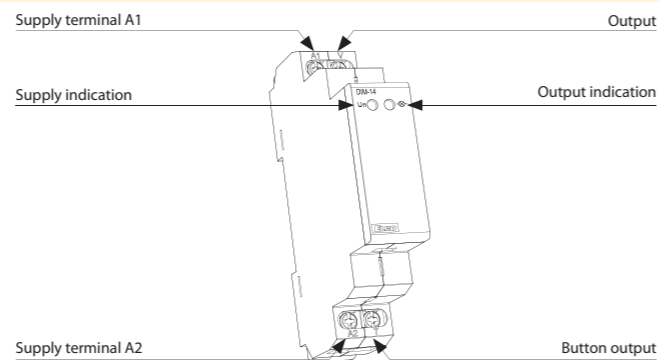

Connection

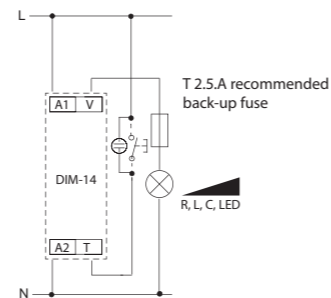

Function

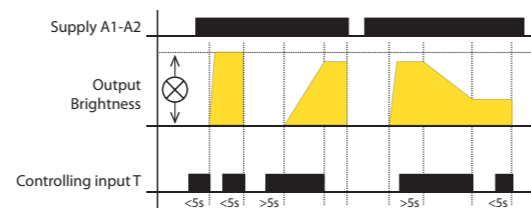

Symbol

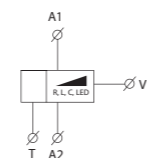

EAN code
SMR-S /230 V: 8595188123518
SMR-U /230 V: 8595188130738

Technical parameters	SMR-S	SMR-U
Connection:	3-wire con., without neutral	4-wire con., with neutral
Voltage range:	230 V AC / 50 Hz	
Burden (unloaded):	max. 0.66 VA / 0.55 W	
Max. dissipated power:	3 W	
Supply voltage tolerance:	-15 %; +10 %	
Output		
Resistive load:	10 - 300 VA	500 VA*
Inductive load:	10 - 150 VA	500 VA*
Capacitive load:	x	500 VA*
Control		
Control voltage:	AC 230 V	
Current:	max. 3 mA	
Impulse length:	min. 50 ms / max. unlimited	
Glow tubes connection:	Yes	
Max. amount of glow lamps connected to controlling input:	230 V - max. amount 10 pcs (measured with glow lamp 0.68 mA / 230 V AC)	
Other information		
Operating temperature:	0 °C to +50 °C (32 °F to 122 °F)	
Operating position:	any	
Mounting:	free at connecting wires	
Protection degree:	IP30 in standard conditions**	
Overvoltage category:	III.	
Pollution degree:	2	
Fuse:	F 1.6 A / 250 V	x
Connection wires:	solid wires 0.75 mm ² (AWG 18) / 90 mm (3.5")	
Glow lamps in a button:	max. number 10	
Dimensions:	49 x 49 x 13 mm (1.9" x 1.9" x 0.5")	
Weight:	30 g (1.06 oz.)	32 g (1.13 oz.)
Standards:	EN 61010-1, EN 60669-2-1	

* with load over 300 VA is necessary to ensure sufficient cooling.

** for more information see page 41

Function

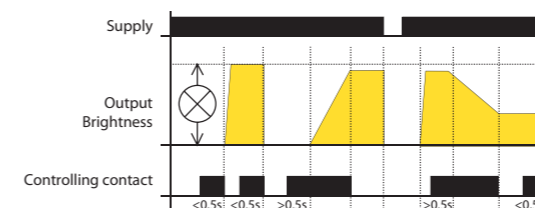

- Button-controlled dimmers designated for flush mounting into a wiring box.
 - Possible to control from more places (parallel connections).
 - Protection against temperature overrun inside the device.
 - **SMR-S:**
 - Designated for dimming el. bulbs, halogen lights and halogen lights with winding transformers and Dimmable LED¹.
 - 3-wire connection, functional without neutral
 - max. load: 300 VA (el. bulbs or halogen lights with wound transformer)
 - contactless output -1x triac
 - with exchangeable fuse.
 - **SMR-U:**
 - Designed for dimming of incandescent bulbs and halogen lights with wound or electronic transformer and Dimmable LED².
 - 4-wire connection
 - max. load: 500 VA (el. bulbs or halogen lights with electronic or wound transformer)
 - contactless output - 2x MOSFET
 - electronic over-heating protection - output off in case of short-circuit or overload.
- ^{1,2} For more information, see page 41

Description of SMR-S

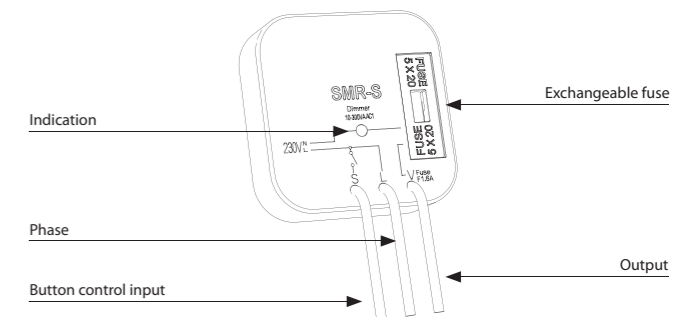

Connection

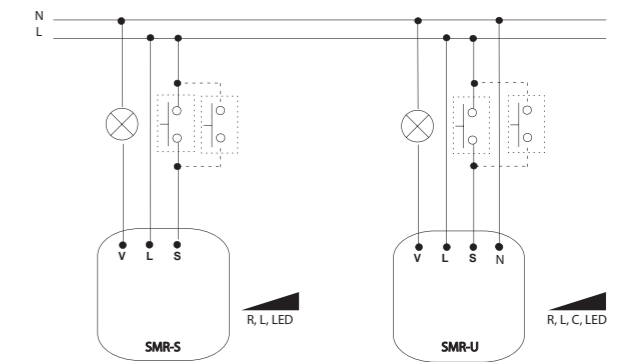

Typical connection of SMR-S - dimmer of lights

Typical connection of SMR-U - dimmer of lights

Warning: it cannot be used for fluorescent lights and energy saving lights!

SMR-U: It is not allowed to connect together loads of inductive and capacitive type in the same time.

Short press (<0.5s) turns a light on, another short press turns it off. A longer press (>0.5s) causes a gradual regulation of light intensity min-max-min round until the button is released. After releasing a set intensity is kept in memory, further short presses turn the light on/off keeping the set intensity. The intensity can be changed by further long press. After de-energising the relay remembers the set value.

LIC-1 | Lighting intensity controller



EAN code LIC-1 + SKS: 8595188144933 SKS photosensor: 8594030337288

Technical parameters		LIC-1
Supply terminals:	A1 - A2	
Supply voltage:	AC 230 V / 50 - 60 Hz	
Burden (unloaded):	max. 1.6 VA / 0.8 W	
Max. dissipated power:	1 W	
Supply voltage tolerance:	±15 %	
Power supply indication:	green LED	
Control		
Button - control terminals:	A1 - T	
Control voltage:	AC 230 V	
Control input power:	max. 0.6 VA	
Control impulse length:	min. 80 ms / max. unlimited	
Glow tubes connection (terminals: A1 - T):	Yes	
Maximum number of connected glow lamps the control input:	230 V - max. amount 50 pcs (measured with glow lamp 0.68 mA / 230 V AC)	
Blocking input - terminals:	A1 - B	
Control. voltage:	AC 230 V	
Supply:	max. 0.1 VA	
Connect glow-lamps (terminals A1 - B):	No	
Impulse length:	min. 80 ms / max. unlimited	
Output		
Output status indication:	red LED	
Load capacity:*	300 W (at cos φ = 1)	
Other information		
Operating temperature:	-20 °C to +35 °C (-4 °F to 95 °F)	
Storage temperature:	-20 °C to +60 °C (-4 °F to 140 °F)	
Operating position:	any	
Mounting:	DIN rail EN 60715	
Ingress protection:	IP40 from front panel / IP10 terminals	
Overvoltage category:	III.	
Contamination degree:	2	
Connecting conductor cross-section (mm²):	solid wire max. 2x 2.5 or 1x 4 with sleeve max. 1x 2.5 or 2x 1.5 (AWG 12)	
Dimensions:	90 x 17.6 x 64 mm (3.5" x 0.7" x 2.5")	
Weight:	66 g (2.33 oz.)	

* Due to a large number of light source types, the maximum load depends on the internal construction of dimmable LEDs and ESL bulbs and their power factor cos φ. The power factor of dimmable LEDs and ESL bulbs ranges from cos φ = 0.95 to 0.4. An approximate value of maximum load may be obtained by multiplying the load capacity of the dimmer by the power factor of the connected light source.

- Overview of dimmable light sources on page 157

Warning: it is not allowed to connect inductive and capacitive loads at the same time.

- Designed for dimming of incandescent bulbs and halogen lights with wound or electronic transformer, dimmable light bulbs and dimmable LED².
 - Automatically regulates the intensity of light in a room.
 - External sensor scans the intensity and based on the preset value it decreases or increases the brightness of light.
 - Operating status:
 - 1 - Off.
 - 2 - Automatic regulation.
 - 3 - Cleaning (maximum level of illumination).
 - 4 - Setting the minimum lighting brightness.
 - 5 - Setting the desired level of illumination.
 - Optional connection of buttons with 50 neon lamps.
 - Blocking the automatic control via external signal.
 - Power supply 230 V AC.
 - 1-MODULE, DIN rail mounting, clamping terminals.
- ² For more information, see page 41

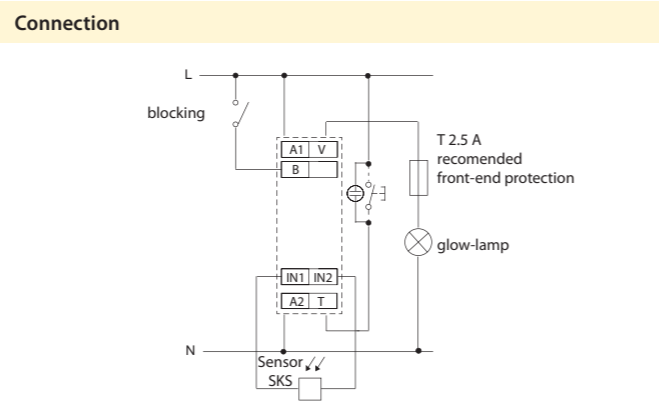
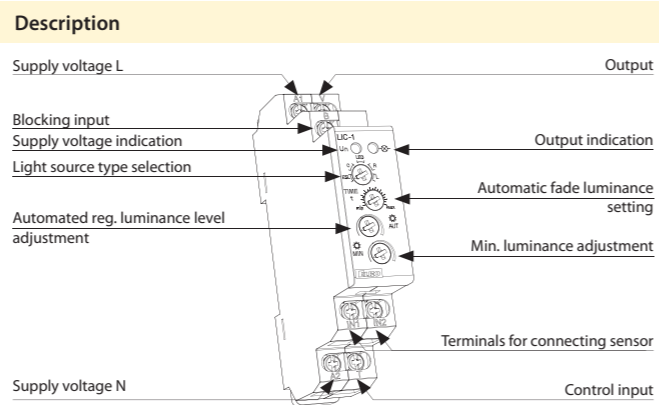

Function

T-button control:
 - pressing button shortly (< 0.5s) always turns of lamp
 - pressing button longer (0.5... 3s) turns on lamp in automatic regulation mode
 - pressing button long (> 3s) turns on lamp to full illumination - „cleaner“ mode
 - after turning on the power supply, the dimmer is always turned off

Thyristor B:
 serves to block automatic regulation (lamp turns off).
 WARNING! The lamp may be turned on in “cleaner” mode even while blocked.
 After ending block mode, the lamp remains off.

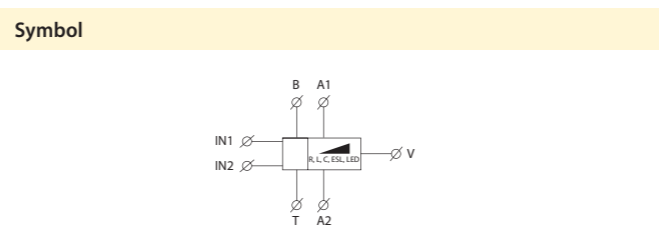

LIC-2 | Lighting intensity controller



EAN code LIC-2 + SKS: 8595188145312 SKS photosensor: 8594030337288

Technical parameters		LIC-2
Supply terminals:	L - N	
Supply voltage:	AC 100 - 250 V / 50 - 60 Hz	
Consumption apparent / loss:	max. 2.7 VA / 1.4 W	
Max. dissipated power (Un + terminals):	4 W	
Power supply indication:	green LED	
Control		
Button - control terminals:	L - T	
Control voltage:	AC 100 - 250 V	
Impulse length:	min. 80 ms / max. unlimited	
Glow tubes connection:	No	
Button - control terminals:	L - B	
Glow tubes connection:	No	
Duration of control pulse:	min. 80 ms / max. unlimited	
Output 1		
Analog:	0 - 10 V / 10 mA max. or 1 - 10 V / 10 mA max.	
Terminals:	OUT+, OUT-	
Galvanically separated:	Yes	
Output 2		
Number of contacts:	1x switching (AgSnO₂)	
Current rating:	16 A / AC1	
Switching capacity:	4000 VA / AC1, 384 W / DC	
Peak current:	30 A / < 3 s	
Switching voltage:	250 V AC1 / 24 V DC	
Output indication:	red LED	
Mechanical life:	3x10⁷	
Electrical life (AC1):	0.7x10⁵	
Other information		
Operating temperature:	-20.. +55 °C (-4 to 131 °F)	
Storage temperature:	-20.. +60 °C (-4 to 140°F)	
Operating position:	any	
Mounting:	DIN rail EN 60715	
Ingress protection:	IP40 from front panel / IP20 terminals	
Overvoltage category:	III.	
Contamination degree:	2	
Connecting cond. cross-section (mm²):	max. 1x 2.5, max. 2x 1.5, with sleeve max. 1x 2.5 (AWG 12)	
Dimensions:	90 x 17.6 x 64 mm (3.5" x 0.7" x 2.5")	
Weight:	79 g (2.8 oz.)	
Standards:	EN 60669-2-1, EN 61010-1, EN 60929	

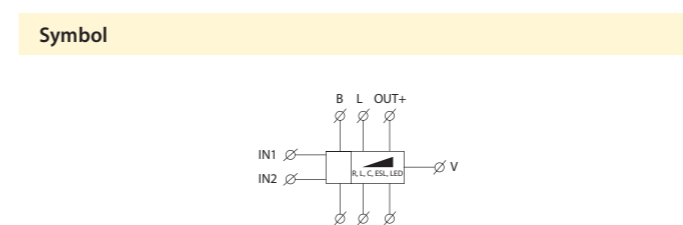

- Serves as control unit for dimmers or electronic ballasts with analog control 0-10 V / 1-10 V.
- Keeps a preset lighting intensity (automatic regulation).
- Control operating modes using existing button:
 - switch OFF
 - automatic regulation
 - cleaning (maximum illumination level)
- Setting the basic parameters of lighting is performed by potentiometers:
 - min. brightness of illumination
 - maximum illumination level
 - speed of dimming / illumination
- Blocking the automatic control using external signal.
- Power supply AC 100 - 250 V.
- 1-MODULE, DIN rail mounting.

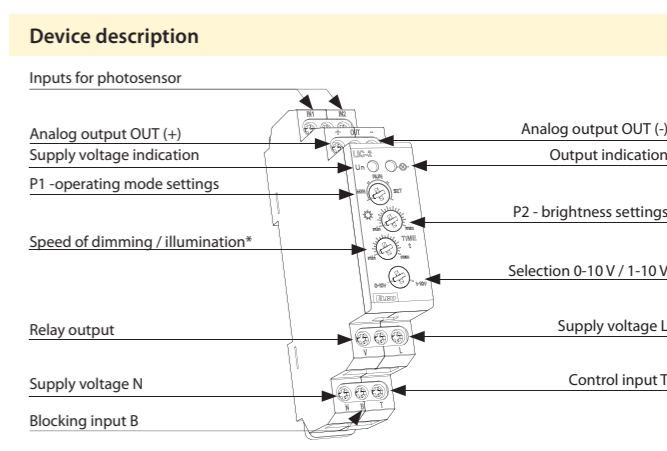

* if the level of brightness on P2 is set on maximum the range is 24...120s

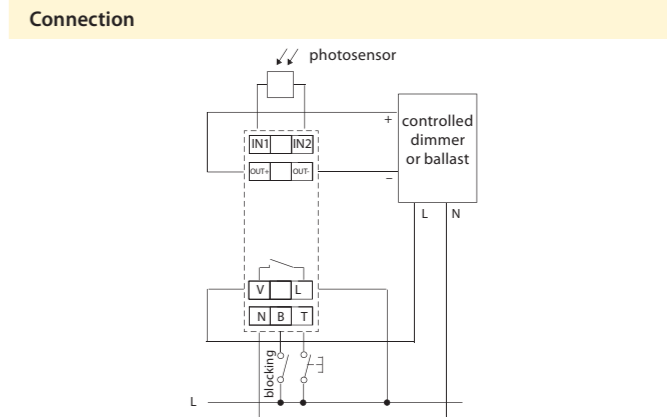

Functions

Control button functions
 - short press (< 0.5s) - always switches off output (relay and output voltage)
 - longer press (0.5...3s) - runs automatic regulation of brightness level (according to sensor)
 - long press (> 3s) - sets the max. brightness level (CLEANING mode).

Blocking input function
 - switches off lighting - only in automatic regulation mode (has no influence in CLEANING mode), e.g. for central switching off of lighting.

Output relay
 - switches on always upon switching on the lighting using the button if the DC output voltage is greater than 0.1V (for the mode 0-10 V) or 1V (for the mode 1-10 V)
 - upon switching off the light, the relay opens if the output voltage drops below the stated limits

Red LED
 - illuminates upon active output (at any brightness level)
 - flashes upon activation of blocking

Stabilized DC - switching

Voltage 12 V



PSB-10-12
IN: AC 110-250 V
OUT: DC 12V stabil
LOAD: 0.84 A / 10 W
- galvanically separated
- electronic fuse
- thermo protection
- MINI, into an installation box (such as KU-68).



PS-10-12
IN: AC 184-250 V
OUT: DC 12 V stabil
LOAD: 0.84 A / 10 W
- galvanically separated
- fusion safety
- electronic fuse
- thermo protection
1 MODULE.



PS-30-12
IN: AC 100-250 V
OUT: DC 12 V stabil
LOAD: 2.5A / 30 W
- galvanically separated
- electronic fuse
- thermo protection
3 MODULE.



DR-60-12
IN: AC 100-240 V
OUT: DC 12 V stabil
LOAD: 4.5A / 54 W
- galvanically separated
- electronic fuse
- range of incoming voltage
4.5 MODULE.



PS-100-12
IN: AC 100-250 V
OUT: DC 12 V stabil
LOAD: 8,4A / 100 W
- galvanically separated
- fusion safety
- electronic fuse
- thermo protection
6 MODULE.

Voltage 24 V



PSB-10-24
IN: AC 110-250 V
OUT: DC 24 V stabil
LOAD: 0.42A / 10 W
- galvanically separated
- electronic fuse
- thermo protection
MINI, into an installation box (such as KU-68).



PS-10-24
IN: AC 184-250 V
OUT: DC 24 V stabil
LOAD: 0.42A / 10 W
- electronic fuse
- thermo protection
1 MODULE.



PS-30-24
IN: AC 100-250 V
OUT: DC 24 V stabil
LOAD: 1.25A / 30W
- galvanically separated
- electronic fuse
- thermo protection
3 MODULE.



DR-60-24
IN: AC 100-240 V
OUT: DC 24 V stabil
LOAD: 2.5A / 60W
- galvanically separated
- electronic fuse
4.5 MODULE.



PS-100-24
IN: AC 100-250 V
OUT: DC 12 V stabil
LOAD: 4,2A / 100 W
- fusion safety
- electronic fuse
- thermo protection
6 MODULE.

Regulated



PS-30-R
IN: AC 100-250 V
OUT: DC 12-24 V regul., stab.
LOAD: 2.5-1.25A / 30W
- galvanically separated
- electronic fuse
- thermo protection
3 MODULE.



ZSR-30
IN: AC 230 V
OUT: DC 5-24 V reg., stab.
OUT: AC 24V, DC24V
LOAD: 1.6-0.3A/10 VA
- range of incoming voltage
- current restrictor
- electronic fuse
3 MODULE.

Nonstabilized AC

Bell transformer



ZTR-8-8
Output voltage 8 V.
Power: 8W.



ZTR-8-12
Output voltage 12 V.
Power: 8W.



ZTR-15-12
Output voltage 4-8-12 V.
Power: 4V 5VA;
8V 10 VA; 12V 15VA.

Stabilized DC - linear

Nonstabilized AC+DC

Type	Design	Input voltage	Output				Protection against overload			Designation	Page in catalogue		
			AC	DC	Stabilized	Output voltage	Output current	Switching (S) / Linear (L)	Safety fuse			Electronic fuse	Short-circuit-proof
ZNP-10-24	3M-DIN	AC 230 V, -15/+10%	●	●	x	AC 24V DC 24V	0.4 A	x	●	x	x	DC and AC nonstabilized output voltage 24 V – where it is not required or is stabilized later	57
ZSR-30	3M-DIN	AC 230 V, -15/+10%	●	●	●	DC 5-24V AC 24 V	1.6 A- 0.3 A	S	●	●	x	regulated output voltage in a wide range DC 5-24 V; possibility to adjust output voltage with load according to request...	57
PSB-10-12	MINI-BOX	AC 110-250 V	x	●	●	DC 12 V	0.84 A	S	x	●	●	stabilized switching power supply with fixed output voltage 12 V / 10 W, box	54
PSB-10-24	MINI-BOX	AC 110-250 V	x	●	●	DC 24V	0.42 A	S	x	●	●	stabilized switching power supply with fixed output voltage 24 V / 10 W, box	54
PS-10-12	1M-DIN	AC 184-250 V, -20/+10%	x	●	●	DC 12 V	0.84 A	S	●	●	●	stabilized switching power supply with fixed output voltage 12 V / 10 W, 1 module	54
PS-10-24	1M-DIN	AC 184-250 V, -20/+10%	x	●	●	DC 24V	0.42 A	S	●	●	●	stabilized switching power supply with fixed output voltage 24 V / 10 W, 1 module	54
PS-30-12	3M-DIN	AC 100-250 V, -20/+10%	x	●	●	DC 12 V	2.5 A	S	●	●	●	stabilized switching power supply with fixed output voltage 12 V / 30 W, 3 module	54
PS-30-24	3M-DIN	AC 100-250 V, -20/+10%	x	●	●	DC 24V	1.25 A	S	●	●	●	stabilized switching power supply with fixed output voltage 24 V / 30 W, 3 module	54
PS-30-R	3M-DIN	AC 100-250 V, -15/+10%	x	●	●	DC 12-24V	2.5 A- 1.25A	S	●	●	●	stabilized switching power supply with fixed output voltage 12-24 V / 30 W, 3 module	54
PS-100-12	6M-DIN	AC 100-250 V, -20/+10%	x	●	●	DC 12 V	8,4A	S	●	●	●	stabilized switching power supply with fixed output voltage 12 V / 100 W, 6 module	54
PS-100-24	6M-DIN	AC 100-250 V, -20/+10%	x	●	●	DC 24V	4.2 A	S	●	●	●	stabilized switching power supply with fixed output voltage 24 V / 100W, 6 module	54
DR-60-12	4.5M-DIN	AC 100-240 V DC 124-370 V	x	●	x	DC 12 V	4.5 A	S	x	x	x	efficient switching power supply of DC voltage 12V / 54 W, wide range of input voltage (AC 100-240 and DC 124-370 V)	56
DR-60-24	4.5M-DIN	AC 100-240 V DC 124-370 V	x	●	x	DC 24V	2.5 A	S	x	x	x	efficient switching power supply of DC voltage 24V / 60 W, wide range of input voltage (AC 100-240 and DC 124-370 V)	56
ZTR-8-8	2M-DIN	AC 230 V, -15/+10%	●	x	x	8V	1A	x	x	x	●	bell transformer (short-circuit-proof) for supplying of bells, door openers, home call-boxes	58
ZTR-8-12	2M-DIN	AC 230 V, -15/+10%	●	x	x	12V	0.66A	x	x	x	●		58
ZTR-15-12	3M-DIN	AC 230 V, +/- 10%	●	x	x	4-8-12V	2-1.5-1A	x	x	x	●		58



- **PSB-10:** switching stabilized power supplies with fixed output voltage, for mounting into an installation box.
 - PSB-10-12 - stabilized power supply 12V/10W.
 - PSB-10-24 - stabilized power supply 24V/10W.
- **PS-10:** switching stabilized power supplies with fixed output voltage, version 1-module.
 - PS-10-12 - stabilized power supply 12 V/10 W.
 - PS-10-24 - stabilized power supply 24 V/10 W.
- **PS-30:** switching stabilized power supplies, version 3-module.
 - PS-30-12 - stabilized power supply with fixed output voltage 12V/30W.
 - PS-30-24 - stabilized power supply with fixed output voltage 24V/30W.
 - PS-30-R - stabilized regulated power supply 12-24 V/30 W.
- **PS-100:** stabilized power supply with fixed output voltage, version 6-module.
 - PS-100-12 - stabilized power supply 12 V/100 W.
 - PS-100-24 - stabilized power supply 24 V/100 W.
- Output current is limited by electronic fuse, in case maximal current is exceeded, the device switches off and after a shot time interval it again switches on.
- Indication of output voltage by green LED on front panel (except PSB-10).
- Temperature protection - if temperature is exceeded, the device switches off and after cooled down, it switches on again.

EAN code

PSB-10-12: 8595188145022	PS-30-12V: 8595188137966
PSB-10-24: 8595188143783	PS-30-24V: 8595188139045
PS-10-12V: 8595188139052	PS-30-R: 8595188136655
PS-10-24V: 8595188139069	PS-100-12V: 8595188137195
	PS-100-24V: 8595188139021

Technical parameters	PSB-10-12	PSB-10-24	PS-10-12	PS-10-24	PS-30-12	PS-30-24	PS-30-R	PS-100-12	PS-100-24
Input									
Voltage range:	AC 110 - 250 V / 50 - 60 Hz		AC 184 - 250 V / 50 - 60 Hz		AC 100 - 250 V / 50 - 60 Hz			AC 100 - 250 V / 50 - 60 Hz	
Burden without load (max.):	3 VA / 0.5 W		5 VA / 2 W		9 VA / 1 W	10 VA / 1.5 W	10 VA / 1.7 W	12 VA / 2 W	
Burden with full load (max.):	26 VA / 13 W		25 VA / 13 W		70 VA / 37 W			195 VA / 121 W	
Protection:	x		fuse T1A		fuse T2A			fuse T 3.15A	
Output									
Output voltage DC / max. current:	12 V / 0.84 A	24 V / 0.42 A	12.2 V / 0.84 A	24.2 V / 0.42 A	12.2 V / 2.5 A	24.2 V / 1.25 A	12.2 V / 2.5 A	12.2 V / 8.4 A	24.2 V / 4.2 A
Tolerance of output voltage:	± 2 %		± 2 %		± 2 %			± 3 %	
Output indication:	x		green LED						
Wave of off-load output voltage:	40 mV		80 mV		30 mV	40 mV	1 V		
Wave of output voltage with max load:	380 mV		20 mV		80 mV	500 mV	40 mV		
Time delay after connection:	max. 1s		max. 1s		max. 5s	max. 1s	max. 3s		
Time delay after over-load:	max. 1s		max. 1s		max. 1s			max. 0.5s	
Efficiency:	> 75 %		> 75 %		> 82 %	> 81 %	>82 %		
Electronic fuse:	electronic protections short-circuit, over load, over voltage (from 120% of rated output)								
Other information									
Working humidity:	20 .. 90% RH								
Operating temperature:	-20 °C to +40 °C (-4 °F to 104°F)								
Storage temperature:	-40 °C to +85 °C (-40 °F to 185 °F)		-40 °C to +85 °C (-40 °F to 185 °F)		-25 °C to +70 °C (-13 °F to 158 °F)			-40 °C to +85 °C (-40 °F to 185 °F)	
Electrical strength input- output:	4kV								
Protection degree:	IP 30		IP40 device/ IP20 in-built in distribution board						
Overvoltage category:	II.								
Polution degree:	2								
Max. cable size (mm ²):	x		solid wire max. 1x 2.5 or 2x 1.5 / with sleeve max. 1x 1.5 (AWG 12)						
Connection wires:	solid wire CY, 4x 0.75mm ² (AWG 18), 90 mm (3.5")		x						
Dimensions:	49 x 49 x 21 mm (1.9 x 1.9 x 0.8")	90 x 17.6 x 64 mm (3.5" x 0.7" x 2.5")	90 x 52 x 65 mm (3.5" x 2.1" x 2.6")	90 x 105 x 65 mm (3.5" x 4.1" x 2.6")					
Weight:	78 g (2.6 oz)	78 g (2.6 oz)	65 g (2.3 oz.)	65 g (2.3 oz.)	160 g (5.6 oz.)	160 g (5.6 oz.)	163 g (5.8 oz.)	377 g (13.3 oz.)	377 g (13.3 oz.)
Standards:	EN 61204-1, EN 61204-3, EN 61204-7								

Device description

PSB-10-12

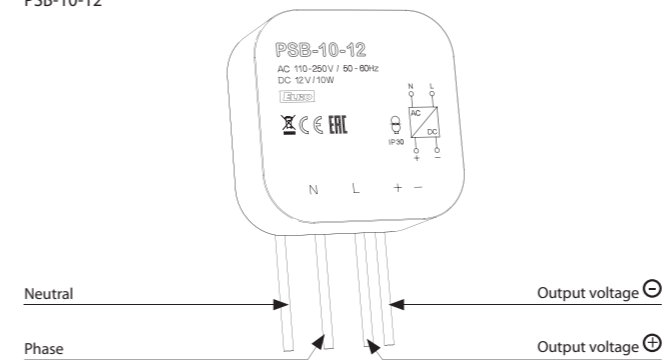

PSB-10-12 / PSB-10-24 designated for installation into an installation box. Suitable for controlling of lighting sources, thermo valves, shutter engines, etc.

PS-10-12

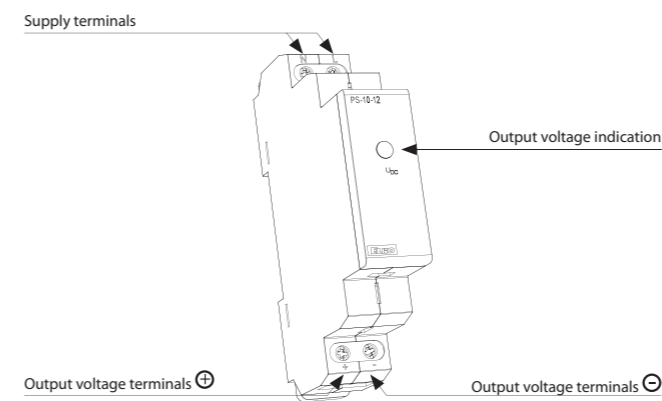

PS-30-12

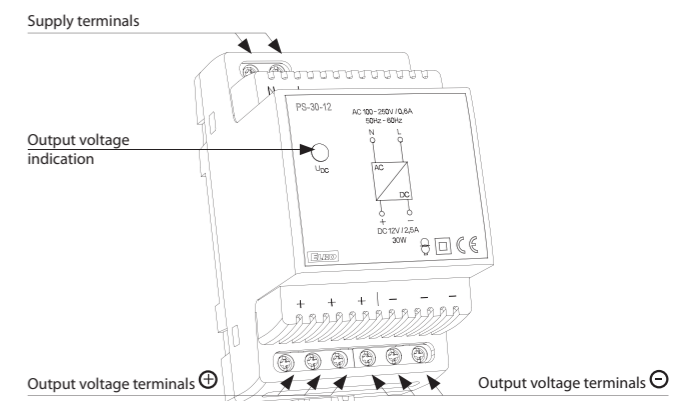

PS-100-12

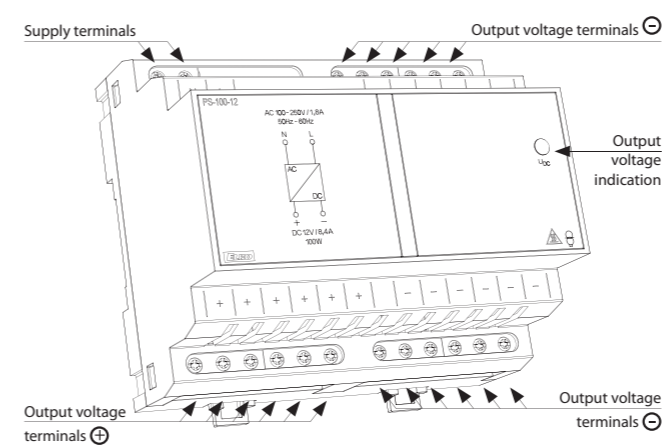

PS-30-R

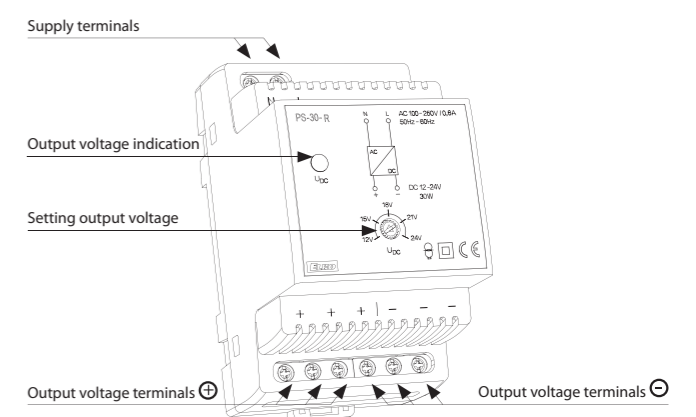

Connection

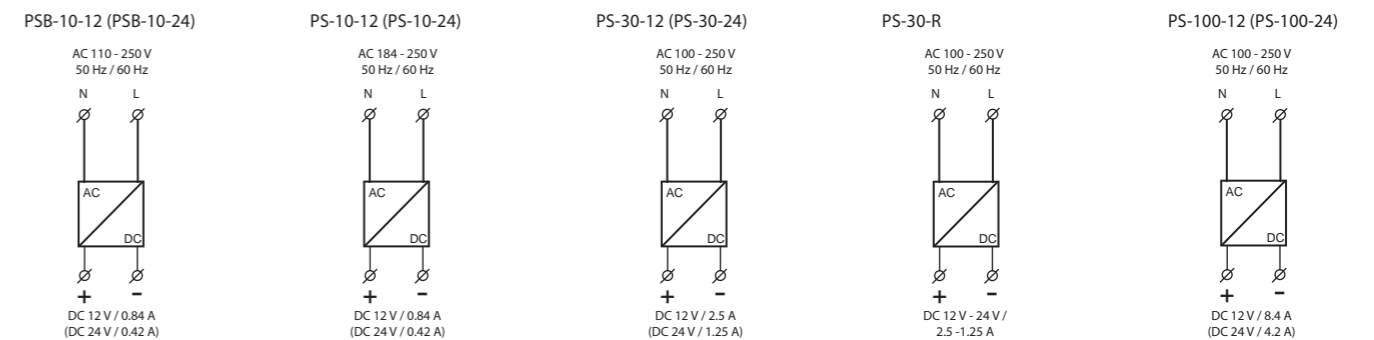



EAN code
DR-60-12V: 8595188125048
DR-60-24V: 8595188125055

Technical parameters	DR-60-12	DR-60-24
Input (U prim)		
Voltage range:	100 - 240 V AC	
Consumption without load (max):	13 VA / 4 W	
Consumption with full load (max):	94 VA / 60 W	
Output (Usec)		
Output voltage:	12 V ±10 %	24 V ±10 %
Max. load:	4.5 A / 54 W	2.5 A / 60 W
Output voltage-no load DC:	12 V ±10 %	24 V ±10 %
Wave of output voltage:	0.12 V	0.15 V
Efficiency:	83.5 %	86 %
Tolerance of output voltage:	±1 %	
Electronic fuse:	electronic protections short-circuit, over load, over voltage	
Fine adjustment of output voltage:	±10 % - rotary potentiometer	
Overload protection:	to 105 - 160 % of rated output	
Time delay after connection:	100 ms for 100 % loading and AC 230 V	
Other information		
Working humidity:	20 - 90 % RH	
Thermal coefficient:	0.03 % / °C (0 to 50 °C) (0.03 % / °F (32 °F to 122 °F))	
Operating temperature:	-20 °C to +60 °C (-4 °F to 140 °F)	
Storage temperature:	-40 °C to +85 °C (-40 °F to 185 °F) / (10 - 95 % RH)	
Electrical strength (prim/sec):	3 kV	
Protection degree:	IP20 device / IP40 in-built in distribution board	
Max. cable size (mm ²):	solid wire max. 1x 2.5 or 2x 1.5 / with sleeve max. 1x 1.5 (AWG 10)	
Dimensions:	78 x 93 x 56 mm (3.1" x 3.7" x 2.2")	
Weight:	258 g (9.1 oz.)	261 g (9.2 oz.)
Standards:	EN 61010-1, EN 61558-1, EN 61558-2-17	

- Stabilized switching power supply.
- Input voltage (Uprim) in a wide range 100 - 240 V AC.
- **DR-60-12:** power supply with fixed output voltage DC 12 V, stabilized 54 W.
- **DR-60-24:** power supply with fixed output voltage DC 24 V, stabilized 60 W.
- Max. load 12 V-4.5 A, 24 V-2.5 A.
- Electronic protection of short-circuit, over-loading, over-voltage, fine setting of output voltage by trimmer in a range ±10%.
- LED power indicator light, viewable from the front panel.
- Ambient air cooled through the perforated housing.
- 4.5-MODULE, DIN rail mounting, isolation class II.

Description

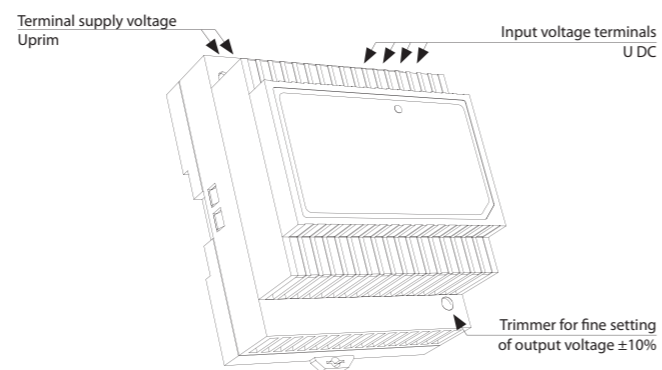

Connection

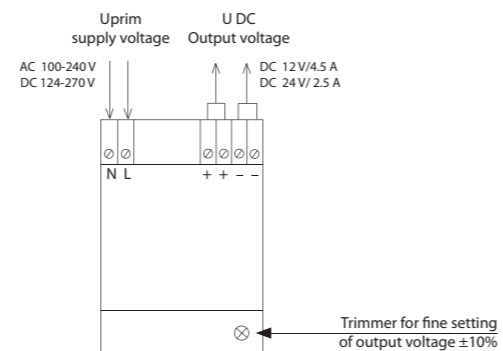

Symbol

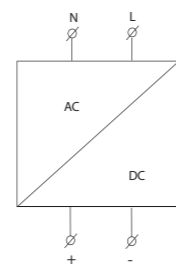

EAN code
ZNP-10-12V: 8594030332733
ZNP-10-24V: 8594030334089
ZSR-30: 8594030331750

Technical parameters	ZSR-30	ZNP-10-24V
Entry (U prim)		
Voltage range:	AC 230 V / 50-60 Hz	
Consumption without load (max):	9 VA / 2.5 W	9 VA / 2 W
Consumption with load (max):	11.5 VA / 8 W	
Supply voltage tolerance:	-15 %; +10 %	
Output (Usec)		
Output voltage:	DC 5-24 V stab. DC 24 V nonstab. AC 24 V	DC 24 V nonstab. AC 24 V
Output voltage-no load AC:	32 V	
Output voltage-no load DC:	44 V	
Fuse:	primary wind T100 mA	
Wave of output voltage:	300 mV	max. 3 V
Efficiency:	75 %	x
Tolerance of output voltage:	±5 %	x
Electronic fuse:	Towards black-out and and current overloading	x
Other information		
Operating temperature:	-20.. +40 °C	
Storing temperature:	-20.. +60 °C	
Electrical strenght (prim/sec):	4 kV	
Protection degree:	IP40 from front panel / IP20 terminals	
Max. cable size (mm ²):	solid wire max. 1x 2.5 or 2x 1.5 / with sleeve max. 1x 1.5 (AWG 12)	
Dimensions:	90 x 52 x 65 mm (3.5" x 2" x 2.6")	
Weight:	398 g (14 oz.)	368 g (13 oz.)
Standards:	EN 61010-1, EN 61558-2-1, EN 61558-1	

WARNING!

Values of max. load are valid for (operational) temperature.
Total loads on all output terminals may not exceed this values:
- by supplying 230 V-253 V - 8W
- from 230 V...207 V output power is proportionately decreasing onto 5 W

Regulated stabilized power supply ZSR-30

- Supply of various devices and appliances by safe voltage with fully galvanic separation from the main.
- Input voltage: AC 230 V.
- Output voltage: DC 5-24 V stab., DC 24 V unstab. and AC 24 V.
- Exceeded current limit values is indicated by LED flashing.
- When there is full short-circuit, output is disconnected, output current is limited by an electronic fuse.
- 3-MODULE, DIN rail mounting.

Nonstabilized power supply ZNP-10-24V

- AC and DC output voltage 24 V, nonstabilized.
- Power supply with fixed output voltage.
- Protection against short-circuit and overload by a safety fuse.
- Input voltage: AC 230 V.
- 3-MODULE, DIN rail mounting.

Description

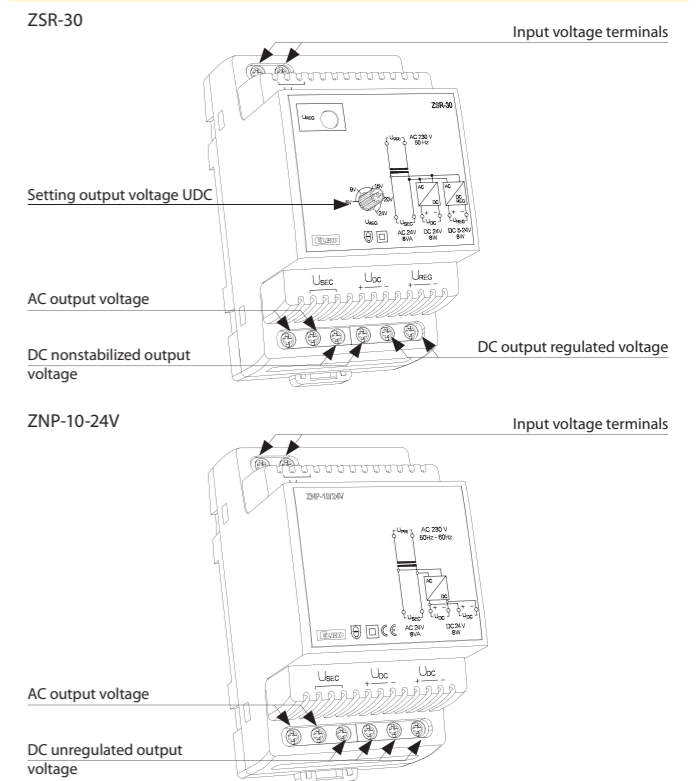

Connection

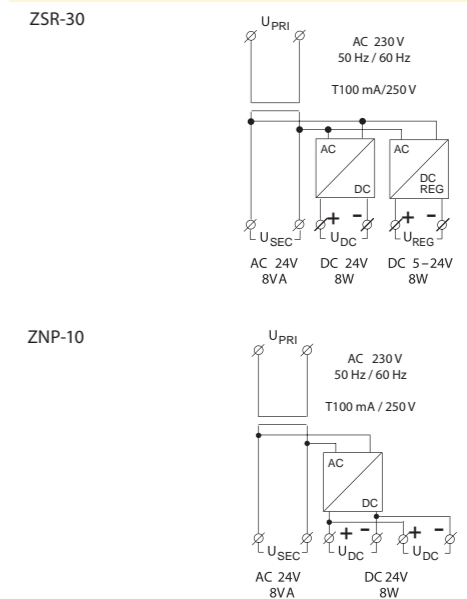



- Designated for general use – e.g. for home bells supply, door locks supply.
 - Input voltage: AC 230 V.
 - Universal power supply with AC input voltage.
 - Short-circuit-proof, doubled output terminals.
- 2-MODULE, DIN rail mounting.
ZTR-8-8: output voltage 8 V.
ZTR-8-12: output voltage 12 V.
- 3-MODULE, DIN rail mounting.
ZTR-15-12: output voltage 4, 8,12V.

EAN code
ZTR-8-8V: 8595188136808
ZTR-8-12V: 8595188136815
ZTR-15-12V: 8595188139281

Technical parameters ZTR-8-8 ZTR-8-12 ZTR-15-12

Entry (U prim)			
Voltage range:	AC 230 V / 50 Hz		
Supply voltage tolerance:	± 10 %		
Consumption without load (max):	70 %		
Output (Usec)			
Output voltage:			AC 4 V AC 8 V AC 12 V
	AC 8 V	AC 12 V	
Output voltage-no load AC:	12 V	16 V	16 V
Max.loability:	8 A	8 VA	4V 5VA, 8V 10 VA, 12 V 15VA
Fuse:	short-circ.resistant		
Other information			
Operating temperature:	-20.. +40°C (-4 °F to 104 °F)		
Storing temperature:	-20.. +60°C (-4 °F to 140 °F)		
Electrical strenght (prim/sec):	4 kV		
Protection degree:	IP20 / 40		
Max. cable size (mm ²):	solid wire max. 1x 2.5 or 2x 1.5 / with sleeve max. 1x 1.5 (AWG 12)		
Dimensions:	90 x 35.6 x 64 mm (3.5" x 1.4" x 2.6")	90 x 52 x 65 mm (3.5" x 2" x 2.6")	
Weight:	337 g (11.9 oz.)	345 g (12.2 oz.)	624 g (22 oz.)

Connection

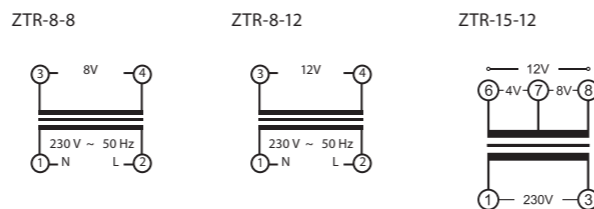

SOU



SOU-1
Twilight switch.
Voltage range:
AC 230 V or
AC/DC 12-240 V
Output contact:
1x changeover/SPDT
16 A.



SOU-2
Twilight switch with
digital time clock.
Voltage range:
AC 230 V / 50 - 60 Hz
Output contact:
1x changeover/SPDT 8 A.



SOU-3
Twilight and light switch.
Voltage range:
AC 230 V / 50 - 60 Hz
Output contact:
1x NO/SPST 16 A.

Accessories of twilight switches



Photosensor SKS
Protection degree: IP44.
It is suitable for mounting on
the wall or in panel.

MEMORY RELAYS

MR



MR-41
Voltage range:
AC 230 V or
AC/DC 12-240 V
Output contact:
1x changeover/SPDT
16 A.



MR-42
Voltage range:
AC 230 V or
AC/DC 12-240 V
Output contact:
2x changeover/DPDT
16 A.

CONTROL AND SIGNALLING DEVICES

USS



USS
Designated for switching,
controlling and signalling
by auxiliary any power
circuits.

- SWITCHES, PUSH BUT-TONS
- SWITCHES WITH GLOW LAMP
- SIGNALLING LIGHT
- BLIND FLANGE

Type	Design	Power supply	Output contact	Other				Designation	Page of catalogue
				LED indication	Display	Internal sensor	External sensor		
SOU-1	1M-DIN	AC 230 V/50-60 Hz	1x 16 A changeover	●	x	x	●	Is used to control lights on the basis of ambient light intensity	61
		AC/DC 12-240 V (AC 50-60 Hz)							
SOU-2	2M-DIN	AC 230 V/50-60 Hz	1x 8 A changeover	x	●	x	●	Is used for control of lights on the basis of ambient light intensity and real time (combination of SOU-1 and time switch clock SHT-1 in one device)	62
SOU-3	IP65	AC 230 V/50-60 Hz (AC 50-60 Hz)	1x 16 A NO-SPST	x	x	●	x	Is used as control of the device on the basis of ambient light intensity	63

Type	Design	Power supply	Output contact	Other			Designation	Page of catalogue
				LED indication	Control output	Function		
MR-41	1M-DIN	AC 230 V/50-60 Hz	1x 16 A changeover	●	●	1	Latching relays, controlled by buttons from several locations can replace three way switches or cross bar switches thanks to control by buttons (unlimited number, connected in parallel by 2 wires), installation gets more transparent and faster for mounting.	64
		AC/DC 12-240 V (AC 50-60 Hz)						
MR-42	1M-DIN	AC 230 V/50-60 Hz	2x 16 A changeover	●	●	2		64
		AC/DC 12-240 V (AC 50-60 Hz)						



EAN code
 SOU-1/230V + SKS: 8595188121002
 SOU-1/UNI + SKS: 8595188121019
 Photosensor SKS: 8594030337288

Technical parameters		SOU-1
Supply terminals:		A1 - A2
Voltage range:	UNI	AC/DC 12 - 240 V (AC 50 - 60 Hz)
Burden (max.):		AC 0.7 - 3 VA / DC 0.5 - 1.7 W
Voltage range:	230	AC 230 V / 50 - 60 Hz
Power input (apparent/loss):		AC max. 12 VA / 1.8 W
Max. dissipated power (Un + terminals):		3.5 W
Supply voltage tolerance:		-15 %; +10 %
Supply indication:		green LED
Time delay:		0 - 2 min
Time delay setting:		potentiometer
Illumination rang 1):		1 - 100 lx
Illumination rang 2):		100 - 50000 lx
Output		
Number of contacts:		1x changeover / SPDT (AgSnO ₂)
Current rating:		16 A / AC1
Breaking capacity:		4000 VA / AC1, 384 W / DC
Inrush current:		30 A / < 3 s
Switching voltage:		250 V AC1 / 24 V DC
Output indication:		red LED
Mechanical life:		3x10 ⁷
Electrical life (AC1):		0.7x10 ⁵
Control		
Power the control input:		0.8 - 530 mVA
Load between S-A2:		Yes
Control. terminals:		A1-S
Glow tubes connctions:		230 V - Yes / UNI - No
Max. amount of glow lamps connected to controlling input:		UNI - glow lamps cannot be connected, 230 V - max. amount 20 pcs (measured with glow lamp 0.68 mA / 230 V AC)
Impulse length:		min. 25 ms / max. unlimited
Reset time:		150 ms
Other information		
Operating temperature:		-20 °C to +55 °C (-4 °F to 131 °F)
Storage temperature:		-30 °C to +70 °C (-22 °F to 158 °F)
Electrical strength:		4 kV (supply - output)
Operating position:		any
Mounting:		DIN rail EN 60715
Protection degree:		IP40 from front panel / IP20 terminals
Sensor cable length:		max. 50 m (standard wire)
Overvoltage category:		III.
Pollution degree:		2
Max. cable size (mm ²):		solid wire max. 1x 2.5 or 2x 1.5 / with sleeve max. 1x 2.5 (AWG 12)
Dimensions of the sensor SKS:		66 x Ø 23.5 mm (2.6" x Ø 0.9")
Weight of sensor SKS:		15 g (0.5 oz.)
Dimensions:		90 x 17.6 x 64 mm (3.5" x 0.7" x 2.5")
Weight:		(UNI) - 76 g (2.7 oz.), (230) - 73 g (2.6 oz.)
Standards:		EN 60255-6, EN 61010-1

- Is used to control lights on the basis of ambient light intensity.
- Used for switching street illumination and garden lights, illumination of advertisements, shop windows, etc.
- Level of ambient intensity is monitored by an external sensor and output is switched according to set level on the device.
- Control input for additional control, e.g. time switch, preswitch etc.
- Level of illumination adjustable in two ranges:
 - 1 - 100 lx and 100 - 50000 lx.
- Adjustable time delay to eliminate short term fluctuation in illumination.
- External sensor IP44 suitable for mounting on the wall (cover and holder of a sensor are a part of the package).
- Supply voltage AC 230 V or AC/DC 12 - 240 V.
- Output contact: 1x changeover/ SPDT 16 A.
- Red LED output indication.
- 1-MODULE, DIN rail mounting.

Description

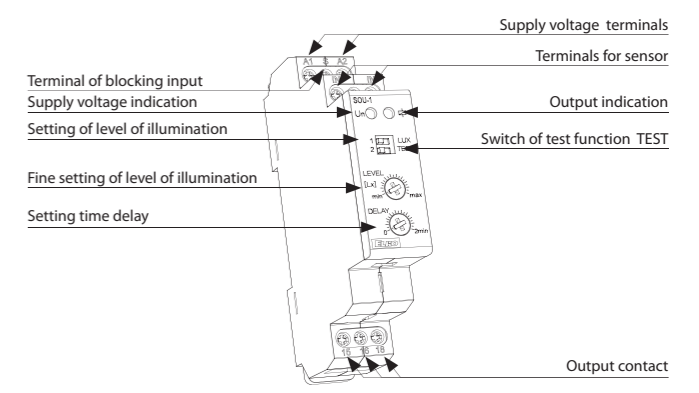

Connection

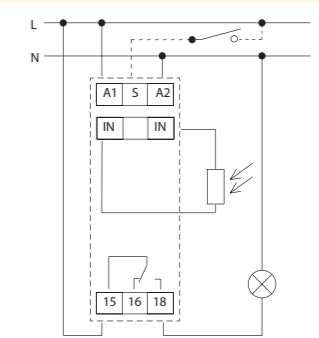

Description of DIP switch

- DIP 1 - LUX
 - ON: 100 - 50000 lx
 - OFF: 1 - 100 lx
- DIP 2 - TEST
 - ON: TEST ON
 - OFF: NORMAL

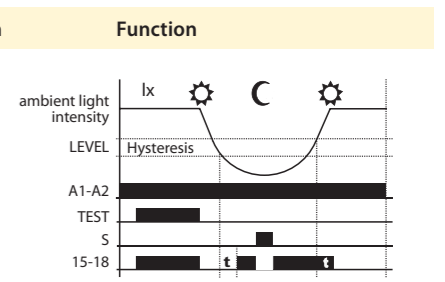

Symbol

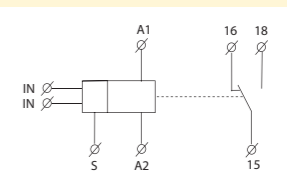



EAN code
SOU-2 + SKS: 8595188130523
SOU-2: 8595188121644
Photosensor SKS: 8594030337288

Technical parameters	SOU-2
Supply terminals:	A1 - A2
Voltage range:	AC 230 V / 50 - 60 Hz
Burden:	max. 4 VA / 1.5 W
Max. dissipated power (Un + terminals):	3 W
Voltage range:	-15 %; +10 %
Back-up supply:	yes
Type of backup battery:	CR 2032 (3V)
Summer / winter time:	automatic

Output	SOU-2
Number of contacts:	1x changeover / SPDT (AgSnO ₂)
Current rating:	8 A / AC1
Breaking capacity:	2000 VA / AC1, 240 W / DC
Switching voltage:	250 V AC1 / 30 V DC
Mechanical life:	3x10 ⁷
Electrical life (AC1):	1x10 ⁵

Time circuit	SOU-2
Power back-up:	3 years
Accuracy:	max. ±1 s day (23 °C / 73.4 °F)
Minimum interval:	1 min
Data stored for:	min. 10 years

Program circuit	SOU-2
Illumination range:	10-50000 lx
Sensor failure indication:	displayed on LCD*
Program place number:	100
Program period:	daily, weekly, yearly
Data readout:	LCD display, illuminated by back up

Other information	SOU-2
Operating temperature:	-10 °C to +55 °C (-4 °F to 131 °F)
Storage temperature:	-30 °C to +70 °C (-22 °F to 158 °F)
Electrical strength:	4 kV (supply - output)
Operating position:	any
Mounting:	DIN rail EN 60715
Protection degree:	IP40 from front panel / IP20 terminals
Overvoltage category:	III.
Pollution degree:	2
Max. cable size (mm ²):	solid wire max. 1x 2.5 or 2x 1.5, with sleeve max. 1x 1.5 (AWG 12)
Dimensions:	90 x 35.6 x 64 mm (3.5" x 1.4" x 2.5")
Weight:	139 g (4.9 oz.)
Dimensions of the sensor SKS:	66 x Ø 23.5 mm (2.6" x Ø 0.9")
Weight of sensor SKS:	15 g (0.5 oz.)
Standards:	EN 61812-1, EN 61010-1, EN 60255-6; EN 60730-1; EN 60730-2-7

- Is used for control of lights on the basis of ambient light intensity and real time (combination of SOU-1 and time switch clock SHT-1 in one device).
- Time clock can override the light sensor for applications when lights are not required.
- Adjustable light intensity 10-50000 lx.
- Function „random switching“ enables simulation of presence in a house when nobody is at home.
- Switching: according to a program (AUTO) / permanently manual / random (CUBE).
- External sensor IP44 issuitable for mounting on the wall / in panel (cover and sensors are part of delivery).
- Sealable transparent cover of front panel.
- Backup of data and time by battery (reserve battery up to 3 years).
- Easy replacement of backup battery with plug-in module located on front panel of device (no disassembly required).
- 2-MODULE, DIN rail mounting .

Description

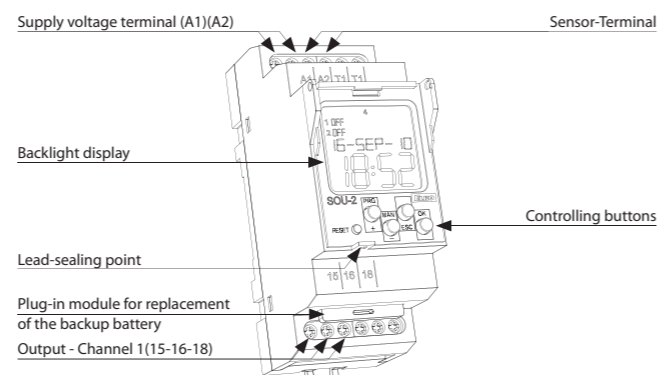

Description of visual elements on the display

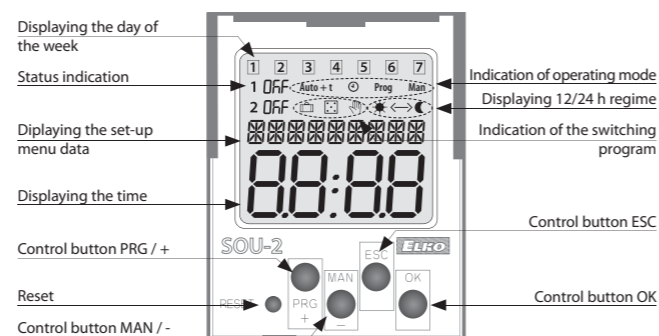

Connection

Symbol

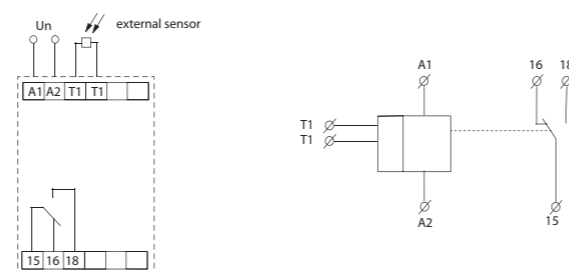

Plug-in module



* ERROR - sensor short circuit



EAN code
SOU-3 /230 V: 8595188140560

Technical parameters	SOU-3
Supply terminals:	L - N
Voltage range:	AC 230 V / 50 - 60 Hz
Input (apparent/loss):	max. 6 VA / 0.7 W
Max. dissipated power (Un + terminals):	2.5 W
Tolerance of voltage range:	-15 % .. +10 %

Setting the scale level of lighting	SOU-3
Function ☾ (twilight switch)	by jumper J2
- range 1:	1 ... 10 lx
- range 2:	10 ... 100 lx
- range 3:	100 ... 1.000 lx
Function ☀ (light switch)	
- range 1:	100 ... 1.000 lx
- range 2:	1.000 ... 10.000 lx
- range 3:	10.000 ... 100.000 lx
Setting function	by jumper J3
Level of light-slight:	0.1 ... 1 x range
Slight setting of light level:	potentiometer
Time delay t:	0 / 1 min. / 2 min.
Delay setting t:	by jumper J1

Output	SOU-3
Output contact:	1x NO- SPST (AgSnO ₂)
Current rating:	12 A / AC1
Switching output:	3000 VA / AC1, 384 W / DC
Peak current:	30 A / < 3 s
Switched voltage:	250 V AC / 24 V DC
Mechanical life:	3 x 10 ⁷
Electrical life:	0.7 x 10 ⁵

Other information	SOU-3
Operation temperature:	-30 °C to +60 °C (-22 °F to 140 °F)
Storing temperature:	-30 °C to +70 °C (-22 °F to 158 °F)
Electrical strength:	4 kV (supply-output)
Operation position:	sensor-side down or on the sides
Protection degree:	IP 65
Overvoltage category:	III.
Pollution level:	2
Max. cable size (mm ²):	max. 1x 2.5, max. 2x 1.5 / with sleeve max. 1x 2.5 (AWG 12)
Suggested power-supply cable:	CYKY 3x 2.5 (CYKY 4x 1.5)
Dimensions:	98 x 62 x 34 mm (3.9" x 2.4" x 1.3")
Weight:	117 g (4.1 oz.)
Standards:	EN 60255-6, 61010-1

Device is standardly supplied with jumper L-15 (3-wire connection). For the correct function of device is necessary sensor-side down device mounting.

- Is used as control of the device on the basis of ambient light intensity.
- External version in IP65, box for mounting on the wall, front cover removable without screws.
- Built in high resolution light sensor.
- Two devices in one, function is set by jumper:
 - twilight switch - contact closes by decreasing of ambient light intensity, and opens by its increasing.
 - light switch - contact closes by increasing ambient light intensity, and opens by decreasing light intensity. Used for switching of devices by reaching of pre-set ambient light level, usually sun shine (pulling down the shutters or blinds, activation of solar panels).
- 3 adjustable (by jumper) ranges of light level.
- 3 adjustable levels of time delay (for elimination of short-term fluctuations of light intensity - for short increases in light intensity).
- Supply voltage 230 V AC.
- Potential-free output contact 12 A / AC1 switching.

Description

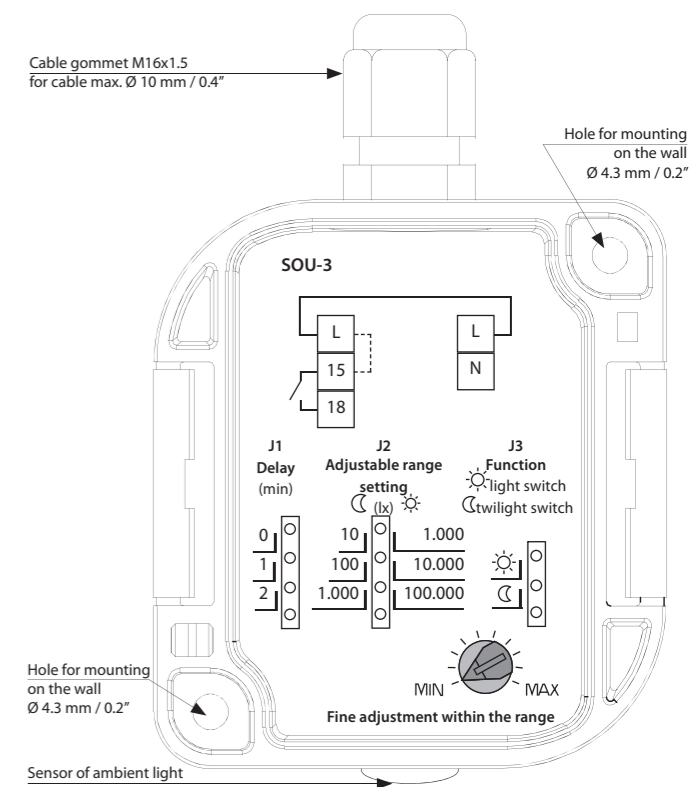

Connection

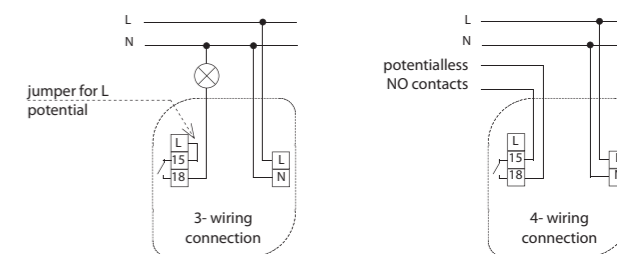

Function

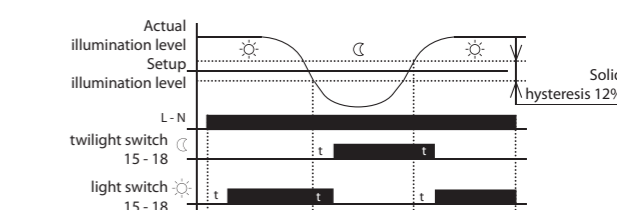



EAN code
MR-41 /230 V: 8595188115889
MR-41 /UNI: 8595188115896
MR-42 /230 V: 8595188115902
MR-42 /UNI: 8595188115919

Technical parameters	MR-41	MR-42
Number of functions:	1	2
Supply terminals:	A1 - A2	
Voltage range:	UNI AC/DC 12 - 240 V (AC 50 - 60 Hz)	
Burden (max.):	AC 0.17 - 3 VA / DC 0.1 - 1.2 W	AC 0.17 - 12 VA / DC 0.11 - 1.9 W
Voltage range:	230 AC 230 V / 50 - 60 Hz	
Consumption (apparent/loss):	AC max. 12 VA / 1.2 W	AC max. 12 VA / 1.9 W
Max. dissipated power (Un + terminals):	3 W	4.5 W
Supply voltage tolerance:	-15 %; +10 %	
Supply indication:	green LED	
Output		
Number of contacts:	1x changeover / SPDT (AgSnO ₂) 2x changeover/ DPDT (AgSnO ₂)	
Current rating:	16 A / AC1	
Breaking capacity:	4000 VA / AC1, 384 W / DC	
Inrush current:	30 A / < 3 s	
Switching voltage:	250 V AC1 / 24 V DC	
Output indication:	red LED	
Mechanical life:	3x10 ⁷	
Electrical life (AC1):	0.7x10 ⁵	
Controlling		
Consumption of input:	AC 0.025 - 0.2 VA / DC 0.1 - 0.7 W (UNI), AC 0.53 VA (AC 230 V)	
Load between A2-ON/OFF:	Yes	
Control terminals:	A1 - ON/OFF	
Glow tubes connections:	230 V - Yes / UNI - No	
Max. amount of glow lamps connected to controlling input:	UNI - glow lamps cannot be connected, 230 V - max. amount 5 pcs (measured with glow lamp 0.68 mA / 230 V AC)	
Impulse length:	min. 25 ms / max. unlimited	
Other data		
Operating temperature:	-20 °C to +55 °C (-4 °F to 131 °F)	
Storage temperature:	-30 °C to +70 °C (-22 °F to 158 °F)	
Electrical strength:	4 kV (supply - output)	
Operating position:	any	
Mounting:	DIN rail EN 60715	
Protection degree:	IP40 from front panel / IP20 terminals	
Overvoltage category:	III.	
Pollution degree:	2	
Max. cable size (mm ²):	solid wire max. 1x 2.5 or 2x 1.5 / with sleeve max. 1x 2.5 (AWG 12)	
Dimensions:	90 x 17.6 x 64 mm (3.5" x 0.7" x 2.5")	
Weight:	(UNI)-64 g (2.3 oz.), (230)-61 g (2.2 oz.)	(UNI)-88 g (3.1 oz.), (230)-85 g (3 oz.)
Standards:	EN 61810-1, EN 61010-1	

- Latching relays, controlled by buttons from several locations can replace three way switches or cross bar switches thanks to control by buttons (unlimited number, connected in parallel by 2 wires), installation gets more transparent and faster for mounting.
- Relays MR-41/UNI, MR-42/UNI memorize its last state even after supply failure. During the failure relay will turn off and after re-energizing will automatically turns on.
- MR-41**
 - output contact: 1x changeover / SPDT 16 A
- MR-42**
 - options - 2x parallel contacts or the other relay is latching
 - function selected via external jumper between B1 - B2
 - output contact: 2x changeover /DPDT 16 A
 - Supply voltage AC 230 V or AC/DC 12-240 V
- 1-MODULE version, DIN rail mounting, controlling by buttons

Connection

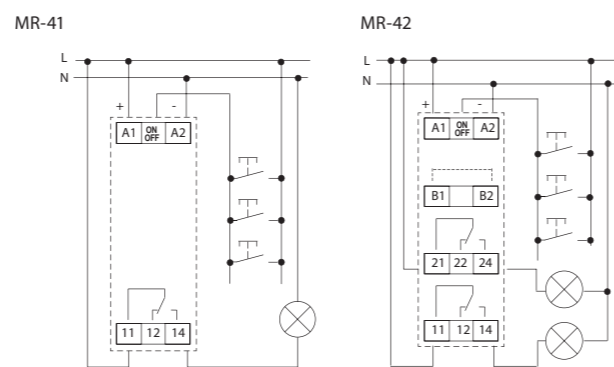

Function

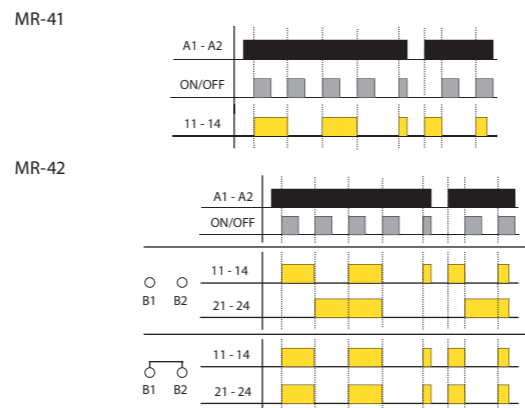

Symbol

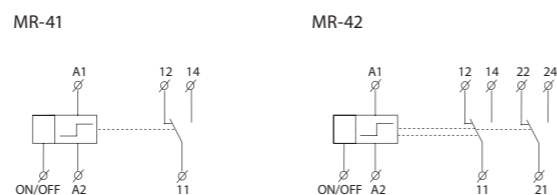

EAN code
USS-ZM: 8595188124577
USS-00: 8595188124614
USS-01: 8595188124621
USS-02: 8595188124638
USS-03: 8595188124645
USS-04: 8595188124652
USS-05: 8595188124669
USS-06/S: 8595188124676
USS-06/R: 8595188136372
USS-07: 8595188124683
USS-08: 8595188124690
USS-09: 8595188124706
USS-10: 8595188124331
USS-11: 8595188124348
USS-12: 8595188124355
USS-13: 8595188124362
USS-14: 8595188124898
USS-15: 8595188124379

Units			
NAME	CONNECTION	RATED CURRENT/VOLTAGE (FOR SWITCHES) SUPPLY VOLTAGE (FOR SIGNALLING LIGHTS)	DESCRIPTION
USS-ZM	MODUL	-	Basic MODULE (housing with terminals and contacts)
USS-00		-	Blind flange
USS-01		6 A / 250 V AC	Switch
USS-02		8 A / 250 V AC	Alternation switch
USS-03		6 A / 250 V AC	Switch with central position
USS-04		6 A / 250 V AC	Switch + button with central position
USS-05		6 A / 250 V AC	Switching button with central position
USS-06/S		8 A / 250 V AC	NO switch
USS-06/R		8 A / 250 V AC	NC switch
USS-07		10 A / 250 V AC	Switch with glow lamp (red)
USS-08		10 A / 250 V AC	Switch with glow lamp (green)
USS-09		10 A / 250 V AC	Switch with glow lamp (yellow)
USS-10		A1-A2, AC 250 V A1-A3, AC/DC 24 V	Signalling LED (red)
USS-11		A1-A2, AC 250 V A1-A3, AC/DC 24 V	Signalling LED (green)
USS-12		A1-A2, AC 250 V A1-A3, AC/DC 24 V	Signalling LED (yellow)
USS-13		A1-A2, AC 250 V A1-A3, AC/DC 24 V	Signalling LED (white)
USS-14		A1-A2, AC 250 V A1-A3, AC/DC 24 V	Signalling LED flashing (red)
USS-15		A1-A2, AC 250 V A1-A3, AC/DC 24 V	Signalling LED (blue)

- Independent switch units designed for flexible controlling and switching of power circuits.
- USS - "Do It Yourself" = it is possible to "click into" different types of switches and signalling units into the basic module.
- Units are delivered as components and configured by the user.
- 15 types of units: switches, push buttons, signal lights of different colours including flashing lights units are replaceable also for future (for example when an application is changed, extended, etc...).
- It is possible to place up to two units into one MODULE (for example 2x switch, 2x signalling lights or combinations) = saves space in switch-board panels.
- 1-MODULE (90 x 17.6 x 64 mm / 3.5" x 0.7" x 2.5"), DIN rail mounting.
- Operating temperature -20 °C to +55 °C (-4 °F to 131 °F).
- M3 screw with clamp terminals.



Switching units (01-09) are made by reputable French company - APEM. The quality of switch-buttons is guaranteed by long-term experiences in the field (from 1952) and by world-recognized certificates VDE and UL. Unique switching mechanism ensures long life of switching at constant parameters.

Make your own device USS - easy and intelligent solution!

- BLIND FLANGE**
Used to fill in an empty position in the front panel of the USS Module. Dimensions: 21 x 15 x 7 mm (0.83" x 0.59" x 0.28"). Color: Grey, RAL7035 (the same as the housing). Unit: 00
- SWITCHES, PUSH BUTTONS**
They have a low uplift and a large fingerboard. High quality contacts, easy rock switch and large button area provide years of useful life. Dimensions: 21 x 15 x 20 mm (0.83" x 0.59" x 0.79"). Unit: 01-06
- SWITCHES WITH GLOW LAMP**
Switch and signalization in one unit. Signalization is carried out by a glow lamp in dolly including series resistance. It is possible to instal it for permanent indication or for an intermitted by contact of the switch. Dimensions: 21 x 15 x 20 mm (0.83" x 0.59" x 0.79"). Colours: red, green, yellow. Supply voltage of the signalling light: AC 250 V. Unit: 07-09
- SIGNALLING LIGHT**
High luminescence SMD/LED that illuminates the entire button area surface. Input voltage can be either AC 230 V or AC/DC 24 V (output light may vary). Red sig. light is delivered also in a flashing version. Unit: 14 Colours: red, green, yellow, white, blue. Unit: 10-15 Dimensions: 21 x 15 x 14 mm (0.83" x 0.59" x 0.55").

Terminal connection Laser marking

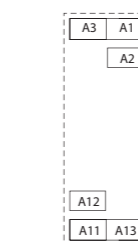

Switches and buttons are marked by laser according to your request in case you order 50 pcs and more.

Example of an order:

USS - ZM
+ USS - 07
+ USS - 11

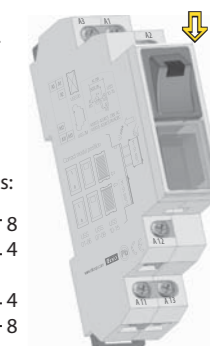

V Voltage

1 phase

AC/DC



HRN-41
(Hysteresis) monitoring DC and AC voltage 10-500 V, divided into 3 inputs and 3 ranges, 2 independent outputs 16 A, 2x time delay.



HRN-42
(Window) as HRN-41 but function WINDOW. Other functions (applicable for HRN-41): faulty state memory, hysteresis, galv. separated supply.



HRN-34
as HRN-33 but in voltage range DC 6-30 V for monitoring battery circuits (6, 12, 24 V).



HRN-64
as HRN-63 but in voltage range DC 6-30 V for monitoring battery circuits (6, 12, 24 V).

AC



HRN-33
Supply and monitored voltage in range AC 48-276 V, 1x output for Umax and Umin adjustable level.



HRN-35
As HRN-33 but individual output for each level (Umax/Umin). Adjustable time delay to eliminate voltage peaks.



HRN-37
As HRN-33, but in voltage range AC 24-150 V.



HRN-63
Supply and monitored voltage in range AC 48-276 V, 1x output for Umax and Umin adjustable level.



HRN-67
as HRN-63, but in voltage range AC 24-150 V.

3 phase



HRN-55
Supply from all phases.



HRN-55N
Supply L1-N (monitors also disconnection of neutral wire). Time delay to eliminate peaks.



HRN-57
Supply from all phases.



HRN-57N
Supply L1-N (monitors also neutral wire disconnection). Adjustable voltage level.



HRN-54
Supply from all phases.



HRN-54N
Supply L1-N (monitors also disconnection of neutral wire). All parameters adjustable by potentiometers.



HRN-56/120
Adjustable level Umin.



HRN-56/208
Adjustable level Umin.



HRN-56/240
Adjustable level Umin.



HRN-56/400
Adjustable level Umin.



HRN-56/480
Adjustable level Umin.



HRN-56/575
Adjustable level Umin.



HRN-43
Galvanically separated supply AC 230V, AC 400 or AC/DC 24V, memory, adjustable hysteresis and delay, 2 x independent output.



HRN-43N
Galvanically separated supply AC 230V, AC 400 or AC/DC 24V, memory, adjustable hysteresis and delay, 2 x independent output.



MPS-1
Optical signaling of three-phase network.

Hz Frequency



HRF-10
for monitoring the frequency of AC voltage. The monitored frequency 50/60/400 Hz is selected by a switch.

Power factor



COS-2
monitors and scores power factor (phase shift between current and voltage $\cos \phi$) in 3phase/1phase circuits (motors, pumps etc.).

A Current

AC/DC



PRI-41
(Hysteresis) 3 inputs divided into 3 ranges (selectable by a switch).



PRI-42
(Window) as PRI-41 but function "WINDOW".

AC



PRI-32
Monitoring by current transformer (wire through an opening, galv. separated, without heat loss), adjust. current 1-20A, multivoltage AC 24-240 and DC 24V, output 8A changeover.



PRI-51
Monitoring of current by in-built transformer, 5 ranges (in versions 1/2/5/8/16A), range 5A is suitable for current transformer (X/5), supply and output as PRI-32, difference from PRI-32: direct monitoring and finer ranges (higher sensitivity) = higher accuracy in measuring.



PRI-52
For scanning the current up to 25 A. Long distance device diagnostics (black-off) Priority relay. Supplying voltage AC 230 V. Output 8A/ SPST switching over.



PRI-53
For scanning the current in three-phase devices. Power supply: 24-240 V AC/DC, galvanically separated from the circuit of the monitored current 2 types depending on the strength of rated current In (1A, 5A).

Level



HRH-8
8 functions, advanced setting for various combinations, galvanically separated supply AC 230 V or AC/DC 24 V, 2 output contacts / 2PDT 16A.



HRH-5
Simple version, 2 functions, galvanically separated supply voltage UNI 24.. 240 V AC/DC.



HRH-6
Device monitors 5 levels by using six probes. Supply voltage: 12-24 V DC or galvanically separated 230 V AC.



HRH-6/S
Additional signalization to HRH-6 with 6 control lights on the front panel of device.



HRH-7
Suitable to operate in harsh conditions due to the high degree of protection IP65. Switch monitors the level changes in wells, reservoirs, tanks, tankers etc.

Level sets



HRH-4
A set of level relay HRH-5 and a contactor VS425. For automatic operation 1-phase and 3-phase pumps. 2 function. IP55.



HRH-VS
Level sets are used to monitor fluid levels.



HRH-MS-1A
HRH-MS-1.6A
Level sets are used to monitor fluid levels.



HRH-MS-VS-2.5A
HRH-MS-VS-4A
HRH-MS-VS-6.3A
Level sets are used to monitor fluid levels.

Accessories



SHR
Level sensors
SHR-1 (M, N) - for monitoring flooding.
SHR-2 - for level detection.
SHR-3 - for demanding and industrial environment.



Cable, wire
D03VV-F 3x0,75/3,2 - cable to SHR-1 and SHR-2 probes.
D05V-K 0,75/3,2 - wire to SHR-1 and SHR-2 probes.

Relays monitor voltage

Type	Design	Voltage	Secure variables						Setting			Description	Page	
			Phases	Range	> U	< U	Failure	Phase sequence	Asymmetry	Delay	Hysteresis			Memory Errors
HRN-33	1-M	from monitored	1	AC 48 - 276 V	•	•	x	x	x	•	x	x	For all types, the delay is adjustable from 0 - 10 seconds (to eliminate short-term outages or peaks). The lower voltage level (Umin) is set in % of the upper level (Umax).	70
HRN-34	1-M	from monitored	1	DC 6 - 30 V	•	•	x	x	x	•	x	x		
HRN-35	1-M	from monitored	1	AC 48 - 276 V	•	•	x	x	x	•	x	x		
HRN-37	1-M	from monitored	1	AC 24 - 150 V	•	•	x	x	x	•	x	x		
HRN-63	1-M	from monitored	1	AC 48 - 276 V	•	•	x	x	x	•	x	x		
HRN-64	1-M	from monitored	1	DC 6 - 30 V	•	•	x	x	x	•	x	x		
HRN-67	1-M	from monitored	1	AC 24 - 150 V	•	•	x	x	x	•	x	x		
HRN-41/230V HRN-41/110V HRN-41/400V HRN-41/24V	3-M	AC 230 V AC 110 V AC 400 V AC/DC 24 V	1	AC/DC 50 V AC/DC 160 V AC/DC 500 V	•	•	x	x	x	•	•	•	Second relay function (independent/parallel). Galvanically separated power supply from measuring inputs.	72
HRN-42/230V HRN-42/110V HRN-42/400V HRN-42/24V	3-M	AC 230 V AC 110 V AC 400 V AC/DC 24 V	1	AC/DC 50 V AC/DC 160 V AC/DC 500 V	•	•	x	x	x	•	•	•	2 output relays, functions of the second relay may be selected (independent/parallel). Galvanically separated power supply.	74
HRN-43/230V HRN-43/110V HRN-43/400V HRN-43/24V	3-M	AC 230 V AC 110 V AC 400 V AC/DC 24 V	3	AC 3 x 84 - 480 V	•	•	•	•	•	•	•	•		
HRN-43N/230V HRN-43N/110V HRN-43N/400V HRN-43N/24V	3-M	AC 230 V AC 110 V AC 400 V AC/DC 24 V	3	AC 3 x 48 - 276 V	•	•	•	•	•	•	•	•	Power supply from all phases, i.e. the relay function is preserved even if one phase fails.	77
HRN-55	1-M	from monitored	3	AC 3 x 300 - 500 V	x	x	•	•	x	•	x	x		
HRN-55N	1-M	from monitored	3	AC 3 x 172 - 287 V	x	x	•	•	x	•	x	x	Power supply L1-N, i.e. the relay also monitors the neutral wire interruption.	77
HRN-57	1-M	from monitored	3	AC 3 x 300 - 500 V	•	•	•	x	x	•	x	x	Power supply from all phases, i.e. the relay function is preserved even if one phase fails.	79
HRN-57N	1-M	from monitored	3	AC 3 x 172 - 287 V	•	•	•	x	x	•	x	x	Power supply L1-N, i.e. the relay also monitors the neutral wire interruption, replacement for HRN-52.	79
HRN-54	1-M	from monitored	3	AC 3 x 300 - 500 V	•	•	•	•	x	•	x	x	If the supply voltage falls below 60% of Un (OFF lower level), the relay will immediately disconnects with no delay. Power supply from all phases, i.e. the relay function is preserved even if one phase fails.	76
HRN-54N	1-M	from monitored	3	AC 3 x 172 - 287 V	•	•	•	•	x	•	x	x	If the supply voltage falls below 60% of Un (OFF lower level), the relay will immediately disconnects with no delay. Power supply L1-N, i.e. the relay also monitors the neutral wire interruption.	76
HRN-56/120 HRN-56/208 HRN-56/240 HRN-56/400	1-M	from monitored	3	AC 3 x 72 - 160 V AC 3 x 125 - 276 V AC 3 x 144 - 276 V AC 3 x 240 - 460 V	x	•	•	•	x	•	x	x	Thanks to the power supply from all three phases, the relay is operational even if one phase fails.	78
HRN-56/480 HRN-56/575	3-M	from monitored	3	AC 3 x 228 - 550 V AC 3 x 345 - 660 V	x	•	•	•	x	•	x	x		

Signal relays

MPS-1	1-M	from monitored	3	AC 3 x 50 - 253 V	x	•	•	•	x	x	x	x	Optical signaling of three-phase network.	80
-------	-----	----------------	---	-------------------	---	---	---	---	---	---	---	---	---	----

Relay for frequency monitoring

Type	Design	Supply voltage	Secure variables				Setting				Description	Page	
			Phases	Frequency Range	Frequency >	Frequency <	Delay	Hysteresis	Frequency >	Frequency <			
HRF-10	3-M	AC 161 - 346 V	1	40 - 60 Hz 48 - 72 Hz 320 - 480 Hz	•	•	•	•	•	•	•	Switchable ranges of rated frequency .	81

Relay for factor cos-φ monitoring

Type	Design	Supply voltage	Secure variables				Setting			Description	Page	
			Phases	cos φ range	> cos φ	< cos φ	Delay	Hysteresis	Memory Errors			
COS-2/230V COS-2/110V COS-2/400V COS-2/24V	3-M	AC 230 V AC 110 V AC 400 V AC/DC 24 V	3	0.1 - 0.99	•	•	•	•	•	•	Two output relays, one independent relay for each level Galvanically separated power supply.	82

Relay for current monitor

Type	Design	Supply voltage	Secure variables				Setting				Description	Page	
			Phases	Range	> I	< I	Delay	Hysteresis	Memory Errors	> I			< I
PRI-32	1-M	AC 24-240 V DC 24 V	1	AC 1-20 A	•	x	x	x	x	•	x	Exceeding the current value - the current flowing through the monitored conductor must not exceed 100 A even on a short-term basis.	84
PRI-41/230V PRI-41/24V	3-M	AC 230 V AC/DC 24 V	1	AC/DC 1.6 A AC/DC 5 A AC/DC 16 A	•	•	•	•	•	•	•	The adjustable delay for elimination of short-term outages and peaks for every level. Galvanically separated power supply.	86
PRI-42/230V PRI-42/24V	3-M	AC 230 V AC/DC 24 V	1	AC/DC 1.6 A AC/DC 5 A AC/DC 16 A	•	•	•	•	•	•	•	The adjustable delay for elimination of short-term outages and peaks for every level. Galvanically separated power supply.	86
PRI-51/0.5 PRI-51/1 PRI-51/2 PRI-51/5 PRI-51/8 PRI-51/16	1-M	AC 24-240 V DC 24 V	1	AC 0.05 - 0.5 A AC 0.1 - 1 A AC 0.2 - 2 A AC 0.5 - 5 A AC 0.8 - 8 A AC 1.6 - 16 A	•	x	•	x	x	•	x	May be used for scanning the current from the current transformer - up to 600A. Power supply is galvanically separated from the measured current.	85
PRI-52	1-M	AC 230 V	1	AC 0.5 - 25 A	•	x	•	x	x	•	x	May be used for scanning the current from the external current transformer - up to 600A.	88
PRI-53/1 PRI-53/5	6-M	AC/DC 24-240 V	3	AC 3 x 0.4 - 1.2 A AC 3 x 2 - 6 A	•	•	•	x	x	•	•	Monitors the drop in the strength of current below the preset value. Monitors exceeding the preset value.	89

Level switches

Type	Design	Supply voltage	Secure variables		Setting			Description	Page
			Level max.	Level min.	Delay	Sensitivity Probe	Function		
HRH-8/230V HRH-8/110V HRH-8/400V HRH-8/24V	3-M	AC 230 V AC 110 V AC 400 V AC/DC 24 V	•	•	•	•	•	Sensitivity adjustable by potentiometer. Galvanically separated power supply.	96
HRH-4/230V HRH-4/24V	set	AC 230 V AC/DC 24 V	•	•	•	•	•	Unit with no protection devices - adequate protection element needs to be integrated before the unit. Ingress protection of the assembly is IP55.	91
HRH-5	1-M	AC/DC 24-240 V	•	•	•	•	•	Measuring the frequency of 10 Hz will protect liquid from polarisation and measuring probes from increased oxidation. Galv. separated power supply.	90
HRH-6/AC HRH-6/DC	box IP65	AC 230 V AC/DC 12-24V	•	•*	•	•	•	* devices mainly designated for monitoring water level in fire-engine tanks.	92
HRH-7	box IP65	AC/DC 24-240 V	•	•	•	•	•	suitable to work in harsh conditions due to the high degree of protection IP65.	94
HRH-VS	set	230 / 400 V AC 50-60 Hz	•	•	•	•	•	Level sets placed in the control cabinet with IP65 protection (protected against dust and spraying water) where everything is already connected.	98
HRH-MS-1A HRH-MS-1.6A	set	230 / 400 V AC 50-60 Hz	•	•	•	•	•		
HRH-MS-VS-2.5A HRH-MS-VS-4A HRH-MS-VS-6.3A	set	230 / 400 V AC 50-60 Hz	•	•	•	•	•		



EAN code
 HRN-33: 8595188115636
 HRN-34: 8595188115643
 HRN-35: 8595188115650
 HRN-37: 8595188130615
 HRN-63: 8595188130622
 HRN-64: 8595188130639
 HRN-67: 8595188130646

Technical parameters

	HRN-33 / HRN-63	HRN-34 / HRN-64	HRN-35	HRN-37 / HRN-67
Supply and measuring				
Terminals:	A1 - A2	A1 - A2	A1 - A2	A1 - A2
Voltage range:	AC 48 - 276 V / 50-60Hz	DC 6 - 30 V	AC 48 - 276 V / 50-60Hz	AC 24-150 V / 50-60Hz
Burden:	AC max. 1.2 VA / 0.5 W	DC max. 1.2 VA / 0.5 W	AC max. 1.2 VA / 0.5 W	AC max. 1.2 VA / 0.5 W
Max. dissipated power (Un + terminals):	4 W	4 W	6 W	4 W
Upper level (Umax):	AC 160 - 276 V	DC 18 - 30 V	AC 160 - 276 V	AC 80-150 V
Bottom level (Umin):	30-95 % Umax	35-95 % Umax	30-95 % Umax	30-95 % Umax
Max. permanent:	AC 276 V	DC 36 V	AC 276 V	AC 276 V
Peak overload < 1 ms:	AC 290 V	DC 50 V	AC 290 V	AC 290 V
Time delay:	adjustable 0 - 10 s			

Accuracy	
Setting accuracy (mechanical):	5 %
Repeat accuracy:	<1 %
Dependence on temperature:	< 0.1 % / °C (°F)
Tolerance of limit values:	5 %
Hysteresis (from fault to normal):	2 - 6 % of adjusted value (only HRN-33, HRN-34, HRN-35, HRN-37)

Output	
Number of contacts:	1x changeover / SPDT (AgNi / Silver Alloy)
Current rating:	16 A / AC1
Breaking capacity:	4000 VA / AC1, 384 W / DC
Inrush current:	30 A / < 3 s
Switching voltage:	250 V AC1 / 24 V DC
Output indication:	red / green LED
Mechanical life:	3x10 ⁷
Electrical life (AC1):	0.7x10 ⁵

Other information	
Operating temperature:	-20 °C to 55 °C (-4 °F to 131 °F)
Storage temperature:	-30 °C to 70 °C (-22 °F to 158 °F)
Electrical strength:	4 kV (supply - output)
Operating position:	any
Mounting:	DIN rail EN 60715
Protection degree:	IP40 from front panel, IP20 terminals
Overvoltage category:	III.
Pollution degree:	2
Max. cable size (mm ²):	solid wire max. 1x 2.5 or 2x 1.5, with sleeve max. 1x 2.5 (AWG 12)
Dimensions:	90 x 17.6 x 64 mm (3.5" x 0.7" x 2.5")
Weight:	62 g (2.2 oz.) 75 g (2.6 oz.) 86 g (3 oz.) 61 g (2.2 oz.)
Standards:	EN 60255-6, EN 61010-1

- It serves to control supply voltage for appliances sensitive to supply tolerance, protection of the device against under/over voltage.
- HRN-3x is band voltage relay, HRN-6x is over/under voltage relay. For difference - see graph of function.
- HRN-33, HRN-63**
 - monitors voltage in range AC 48 - 276 V
 - Umax and Umin can be monitored independently
- HRN-34, HRN-64**
 - like HRN-33, but voltage range is DC 6 - 30 V
 - monitoring of battery circuits (24 V)
- HRN-35**
 - like HRN-33, but independent output relays for each voltage level
 - switching of other loads possible
- HRN-37, HRN-67**
 - like HRN-33, monitors voltage in range AC 24 - 150 V
 - it is possible to monitor level of overvoltage and undervoltage independently
- Adjustable time delay for all types is 0 - 10 s (to eliminate short voltage drops or peaks).
- Voltage Umin adjusted as % of Umax.
- 3-state indication - LEDs indicating normal state and 2 fault states.
- Supply from monitored voltage (monitors level of its own supply).
- 1-MODULE, DIN rail mounting.

Description

HRN-35

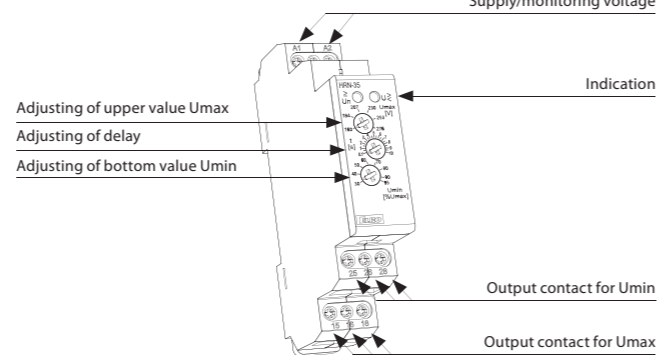

HRN-37

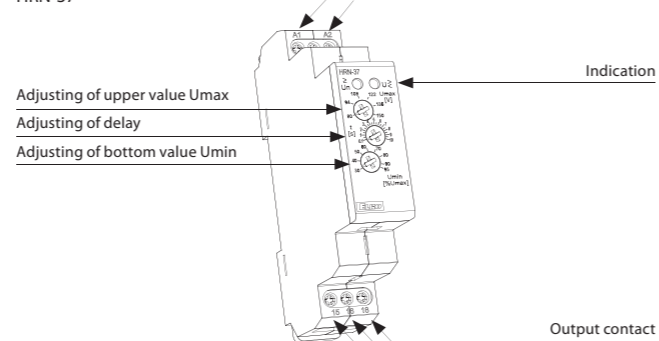

Connection

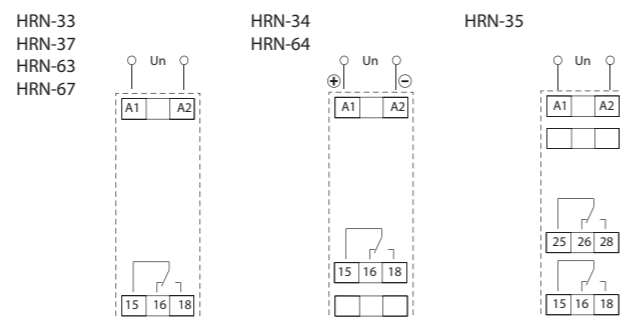

Function HRN-33, 34, 35, 37 (band voltage relay)

HRN-33, HRN-37

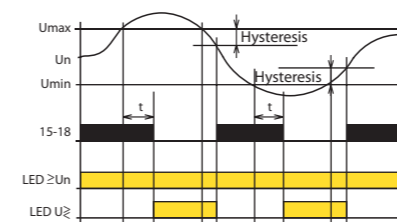

HRN-34

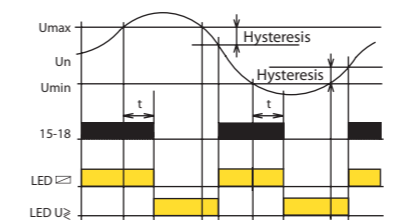

HRN-35

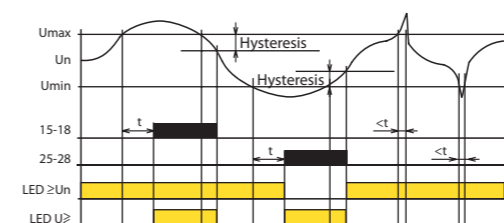

Function HRN-63, 64, 67 (over/under voltage relay)

HRN-63, HRN-64, HRN-67

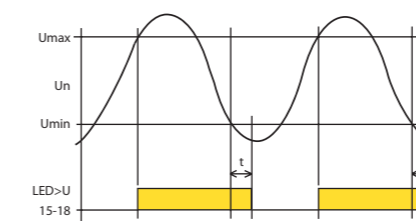

Legend:

Umax - upper adjustable level of voltage
 Un - measured voltage
 Umin - bottom adjustable level of voltage
 15-18 - switching contact of output relay No.1
 25-28 - switching contact of output relay No. 2
 LED ≥ Un - green indicator light
 LED U ≥ - red indicator light
 LED U > - red indicator light

Monitoring relay series HRN-3x monitors level of voltage in single - phase circuits. Monitored voltage serves also as supply voltage. It is possible to set two independent (all occurrences) levels of voltage, when exceeded the output is activated. HRN-33 and HRN-34 - in normal state the output relay is permanently switched. It switches off when there is a limit settings. This combination of linkage of the output relay is advantageous when the full failure of supply (monitored) voltage is considered to be a faulty state in the same way as a decrease of voltage within the set level. Output relay is in both situations always switched off.

Differently HRN-35 version uses independent relay for each level, in normal state it is switched off. If the upper level is exceeded (for example overvoltage) 1 relay switches on, when the bottom level (e.g. undervoltage) is exceeded 2 relay switches. It is thus possible to see the particular faulty state. To eliminate short peaks in the main the time delay, which is possible to be set in range 0 - 10 s, is used. It functions when changing from normal to faulty state and prevents unavailing pulsation of the output relay caused by parasitive peaks. Time delay doesn't apply when changing from faulty to normal state, but hysteresis (1-6% depends on the voltage setting) apply. Thanks to changeover contacts it is possible to get other configurations and functions according to actual requirements of the application.

Monitoring relay line HRN-6x serves to monitor levels of voltage in single-phase or DC circuits. Monitored voltage is in the same time also supply voltage. It is possible to set two independent levels of voltage. When Umax is exceeded, output is activated. In case voltage level falls below Umin, output is deactivated. This combination is advantageous when full absence of supply voltage is understood as faulty state, as well as voltage drop within the set level. To eliminate short voltage peaks in the main there is time delay which can be set in a range of 0-10 sec. Such delay applies in case of going from overvoltage to undervoltage. In case of returning from undervoltage to overvoltage this delay doesn't apply. Thanks to changeover output contacts it is possible to reach various configurations and functions according to requirements or an application.

Symbol

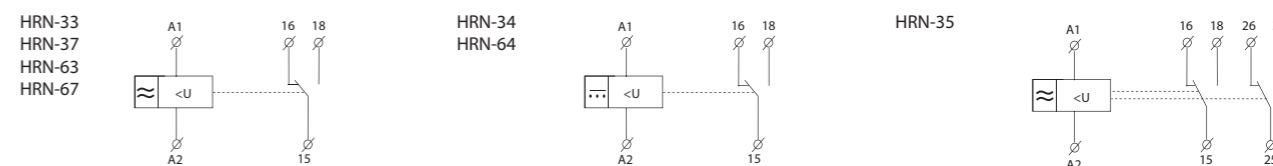

Indication LED

HRN-33, HRN-37

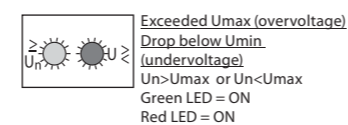
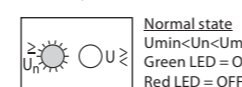

HRN-35

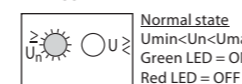

HRN-34

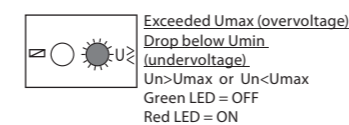
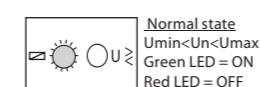

HRN-63, HRN-67

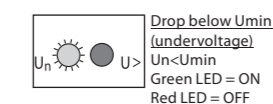
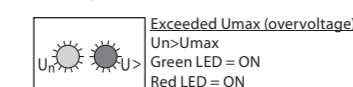

HRN-64

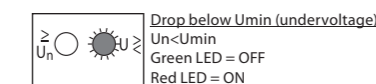
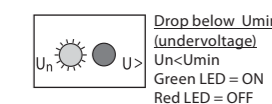
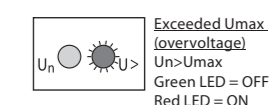



EAN code
 HRN-41 / 110V: 8595188140430
 HRN-41 / 230V: 8595188140409
 HRN-41 / 400V: 8595188140423
 HRN-41 / 24V: 8595188140416
 HRN-42 / 110V: 8595188140478
 HRN-42 / 230V: 8595188140447
 HRN-42 / 400V: 8595188140461
 HRN-42 / 24V: 8595188140454

Technical parameters	HRN-41	HRN-42
Supply		
Supply terminals:	A1 - A2	
Voltage range:	AC 110 V, AC 230 V, AC 400 V or AC/DC 24 V (AC 50-60Hz)	
Burden max.:	5 VA / 2.5 W (AC 110 V, AC 230 V, AC 400 V), 2 VA / 2.5 W (AC/DC 24 V)	
Max. dissipated power (Un + terminals):	7 W (110 V, 230 V, 400 V), 6 W (24 V)	
Supply voltage tolerance:	-15 %; +10 %	
Measuring		
Ranges:*	AC/DC 10 - 50 V (AC 50 - 60 Hz)	AC/DC 32 - 160 V (AC 50 - 60 Hz)
Terminals:	C - B1	C - B2
Input resistance:	212 kΩ	676 kΩ
Max. permanent overload:	100 V	300 V
Peak overload <1ms:	250 V	700 V
Time delay for Umax:	adjustable 0.1 - 10 s	
Time delay for Umin:	adjustable 0.1 - 10 s	
Accuracy		
Setting accuracy (mechanical):	5 %	
Repeat accuracy:	<1 %	
Dependance on temperature:	< 0.1 % / °C (°F)	
Tolerance of limit values:	5 %	
Hysteresis (from fault to normal):	selectable 5 % / 10 % from range	
Output		
Number of contacts:	2x changeover/ SPDT (AgNi / Silver Alloy)	
Current rating:	16 A / AC1	
Breaking capacity:	4000 VA / AC1, 384 W / DC	
Inrush current:	30 A / < 3 s	
Switching voltage:	250 V AC1 / 24 V DC	
Output indication:	yellow LED	
Mechanical life:	3x10 ⁷	
Electrical life (AC1):	0.7x10 ⁵	
Other information		
Operating temperature:	-20 °C to +55 °C (-4 °F to 131 °F)	
Storage temperature:	-30 °C to +70 °C (-22 °F to 158 °F)	
Electrical strength:	4 kV (supply - output)	
Operating position:	any	
Mounting:	DIN rail EN 60715	
Protection degree:	IP40 from front panel / IP20 terminals	
Overvoltage category:	III.	
Pollution degree:	2	
Max. cable size (mm ²):	solid wire max. 1x 2.5 or 2x 1.5 / with sleeve max. 1x 1.5 (AWG 12)	
Dimensions:	90 x 52 x 65 mm (3.5" x 2" x 2.6")	
Weight:	249 g (110V, 230 V, 400 V) (8.8 oz.), 146 g (24 V) (5.1 oz.)	
Standards:	EN 60255-6, EN 61010-1	

- Relay designed for monitoring DC and AC voltage in three ranges.
- The relay controls the size of the voltage in two independent levels (Umin, Umax).
- Setting the monitored level Umax (in % of range.)
- Setting the monitored level Umin (in % of range - for HRN-42 -function WINDOW), (in % of the set upper limit - for HRN-41 - function HYSTERESIS).
- Adjustable function "MEMORY".
- Function of second relay (independently / in parallel).
- Adjustable delay for eliminating short-term outages and surges for every level independently.
- Galvanically separated power supply from monitoring inputs.
- Output contact 2x switching 16 A / 250 V AC1 for each monitored voltage level.
- In 3-MODULE design, fixing to DIN rail.

Description

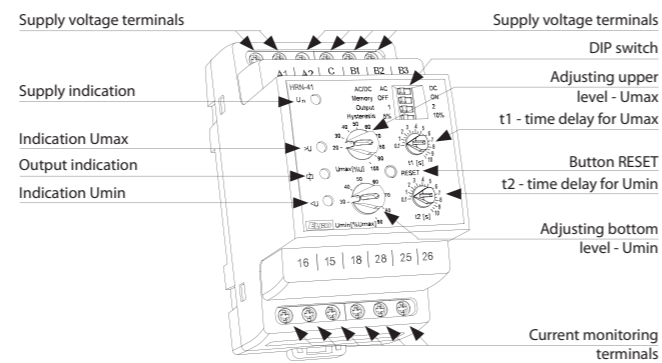

Description and importance of DIP switches

AC/DC AC	<input type="checkbox"/>	DC	← Measured AC / DC voltage
Memory OFF	<input type="checkbox"/>	ON	← MEMORY function
Output 1	<input type="checkbox"/>	2	← Relay function setting
Hysteresis 5%	<input type="checkbox"/>	10%	← Hysteresis setting

Connection

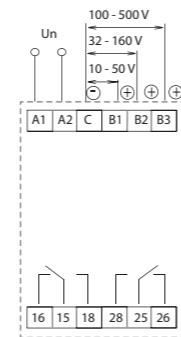

Symbol

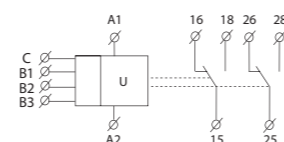

Function

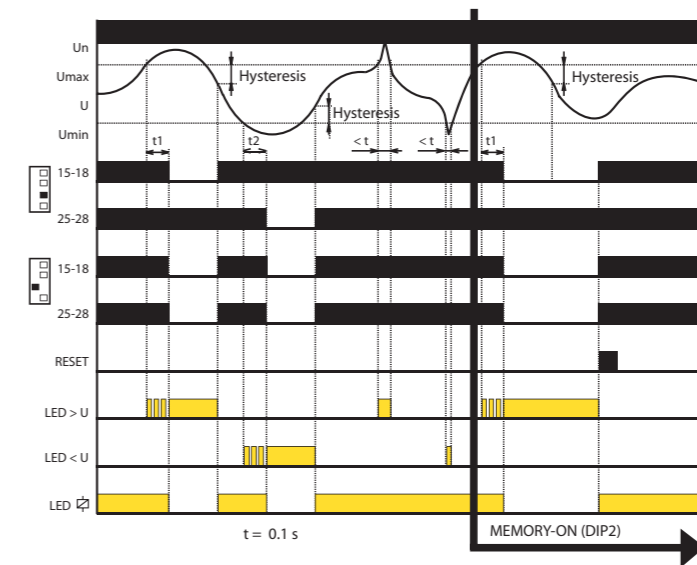

- if the value of the monitored voltage is in the zone between the set upper and lower levels, the status OK occurs - both relays are closed and the yellow LED illuminates. If the value of the monitored voltage is outside the set limits ($> U_{max}$ or $< U_{min}$), an error state occurs.
- when moving to an error state $U > U_{max}$, it times the delay t_1 and a red LED $> U$ simultaneously flashes. After the t_1 time elapses, the red LED $> U$ illuminates and the relevant relay opens.
- when moving to an error state $U < U_{min}$, it times the delay t_2 and a red LED $< U$ simultaneously flashes. After the time t_2 elapses, the red LED $< U$ illuminates and the relevant relay opens.
- when moving from the error status to the OK status, the relevant red LED immediately goes out, and the corresponding relay closes.

* Only one of the inputs can be connected.



EAN code
 HRN-43 / 110V: 8595188130387
 HRN-43 / 230V: 8594030337660
 HRN-43 / 400V: 8595188121316
 HRN-43 / 24V: 8594030338087
 HRN-43N / 110V: 8595188121323
 HRN-43N / 230V: 8594030338216
 HRN-43N / 400V: 8595188120258
 HRN-43N / 24V: 8594030338094

Technical parameters	HRN-43	HRN-43N
Supply		
Supply terminals:	A1 - A2	
Supply voltage:	AC 110 V, AC 230 V, AC 400 V, AC/DC 24 V / (AC 50 - 60 Hz)	
Consumption max.:	5 VA / 2.5 W (AC 110 V, AC 230 V, AC 400 V), 2 VA / 1.4 W (AC/DC 24 V)	
Max. dissipated power	6.5 W (110 V, 230 V, 400 V), (Un + terminals): 5.5 W (24 V)	
Supply voltage tolerance:	-15 %; +10 %	
Measuring circuit		
Voltage set:	3x 400 V / 50 Hz	3x 400 V / 230 V / 50 Hz
Monitored terminals:	L1, L2, L3	L1, L2, L3, N
Upper voltage level:	240 - 480 V	138 - 276 V
Bottom voltage level:	35 - 99 % Umax	
Max. permanent overload:	3x 480 V	
Hysteresis:	adjustable 5 % or 10 % of set value	
Asymmetry:	5 - 20 %	
Peak overload < 1 ms:	600 V < 1 ms	350 V < 1 ms
Time delay t1:	fixed, max. 200 ms	
Time delay t2:	adjustable 0.1-10 s	
Accuracy		
Set. accuracy (mechanical):	5 %	
Repeat accuracy:	< 1 %	
Temperature dependance:	< 0.1 % / °C (°F)	
Limit values tolerance:	5 %	
Output		
Number of contacts:	2x changeover / SPDT (AgNi / Silver Alloy)	
Rated current:	16 A / AC1	
Switching capacity:	4000 VA / AC1, 384 W / DC	
Inrush current:	30 A / < 3 s	
Switching voltage:	250 V AC1 / 24 V DC	
Mechanical life:	3x10 ⁷	
Electrical life (AC1):	0.7x10 ⁹	
Other information		
Operating temperature:	-20 °C to 55 °C (-4 °F to 131 °F)	
Storage temperature:	-30 °C to 70 °C (-22 °F to 158 °F)	
Electrical strength:	4 kV (supply - output)	
Operating position:	any	
Mounting:	DIN rail EN 60715	
Protection degree:	IP40 from front panel / IP20 terminals	
Overtoltage category:	III.	
Pollution degree:	2	
Max. cable size (mm ²):	solid wire max. 1x 2.5 or 2x 1.5 / with sleeve max. 1x 1.5 (AWG 12)	
Dimensions:	90 x 52 x 65 mm (3.5 x 2 x 2.6")	
Weight:	248 g (110V, 230 V, 400 V) (8.7 oz.), 146 g (24 V) (5.1 oz.)	
Standards:	EN 60255-6, EN 61010-1	

- monitoring of 3-phase mains:
 - voltage in 2 levels (undervoltage and overvoltage) in range 138-276 V (3x 400 V / 230 V) or 280-480 V (3x 400 V)
 - phase asymmetry (can be switched off)
 - phase sequence
 - phase failure
- adjustable function „MEMORY“
- function of second relay (independent / parallel)
- adjustable delay for short peaks for each level independently
- **HRN-43:** for circuits 3x 400 V (without neutral)
- **HRN-43N:** for circuits 3x 400 / 230 V (with neutral)
- galvanically separated supply voltage AC 400 V, AC 110 V, AC 230 V, AC/DC 24 V
- output contact: 2x changeover 16 A / 250 V AC1
- 3-MODULE, DIN rail mounting

Description

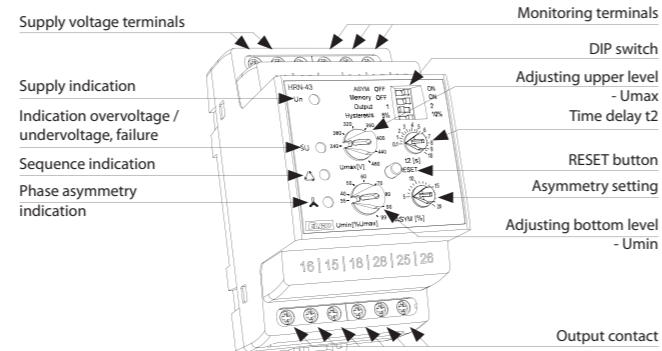

Description and importance of DIP switches

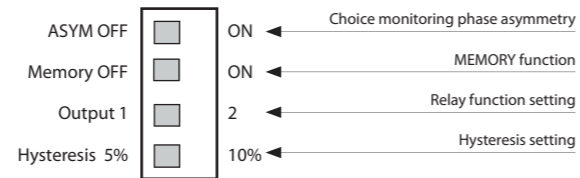

Connection

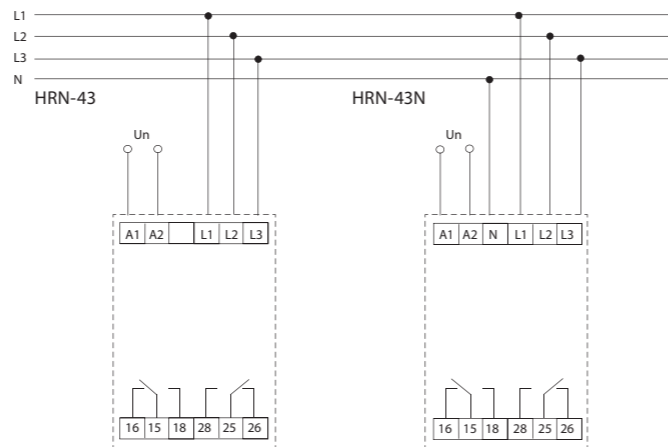

Symbol

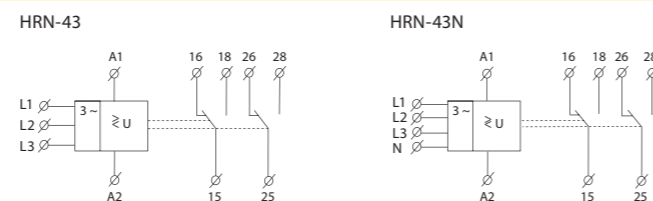

Function

Overtoltage - undervoltage

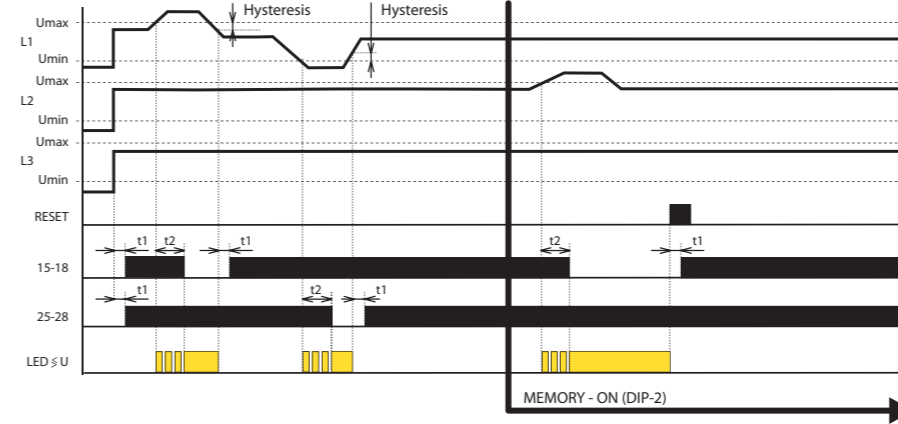

Legend:
 L1, L2, L3 - 3-phase voltage
 RESET - press of the button on frontal panel
 t1 - time delay, fixed
 t2 - time delay, adjustable
 15-18 output relay 1
 25-28 output relay 2
 LED $\geq U$ - indication overvoltage / undervoltage

Selection of 2nd the relay function:
 In order to monitor 2 levels of voltage, it is possible to select if output relay will respond to each level individually (see the diagram) or both relays will switch in parallel way (see diagram "phase sequence").
 Selection via DIP switch Output.

Phase sequence

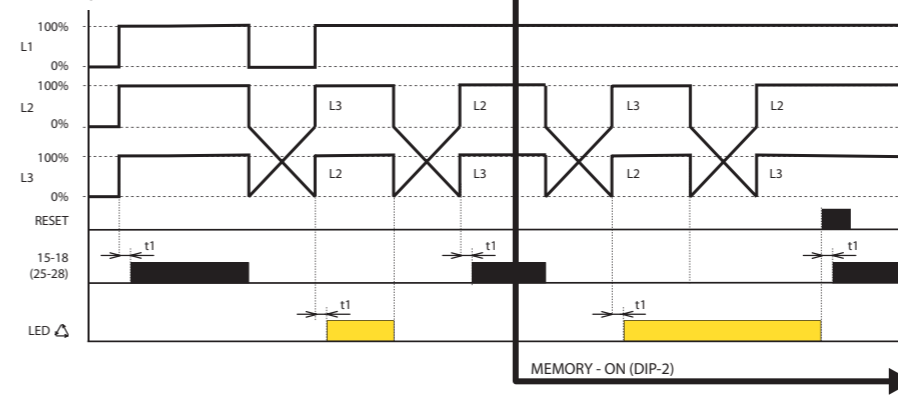

Legend:
 L1, L2, L3 - 3-phase voltage
 RESET - press of the button on frontal panel
 t1 - time delay, fixed
 t2 - time delay, adjustable
 15-18 output relay 1
 25-28 output relay 2
 LED Δ - indication of phase sequence

Selection of 2nd relay function:
 The function is not implied in the monitoring phase sequence, the relays are switched in parallel way.
 DIP switch Output is ignored.

Asymmetry - phase failure

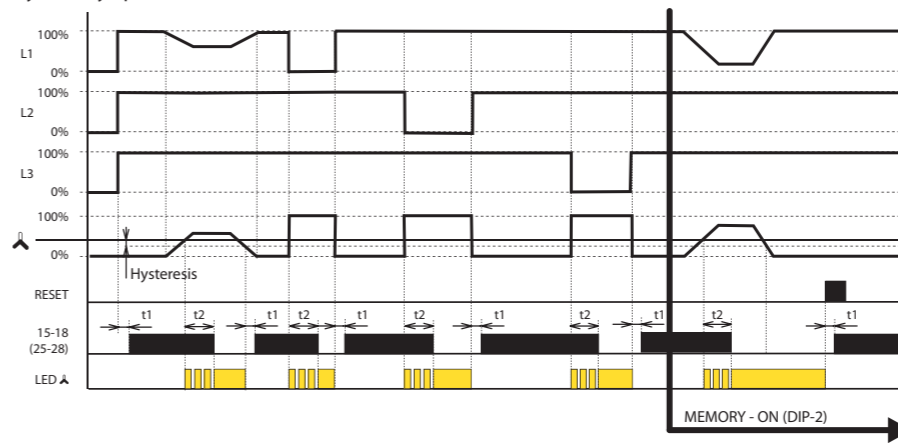

Legend:
 L1, L2, L3 - 3-phase voltage
 RESET - press of the button on frontal panel
 t1 - time pause, fixed
 t2 - time pause, adjustable
 Δ - adjustable asymmetry
 15-18 output contact of relay 1
 25-28 output contact of relay 2
 LED Δ - asymmetry indicator

Selection of 2nd relay function:
 The function is not implied in the monitoring phase sequence, the relays are switched in parallel way.
 DIP switch Output is ignored.

Relay is designated to monitor 3-phase circuits. Type HRN-43N controls voltage towards neutral wire, type HRN-43 controls interphase voltage. Relay can monitor voltage in two levels (overvoltage / undervoltage), phase asymmetry, sequence and failure. Each faulty state is indicated by individual LED. By DIP switch (Output) it is possible to define function of the other relay - independent function (1x for overvoltage, 1x for undervoltage) or in parallel. Time delays t1 (fixed) - when changing from faulty to normal state or when de-energized and t2 (adjustable) when changing from normal to faulty state. These delays prevent incorrect conduct and oscillation of output device during short voltage peaks in the main or during gradual voltage decline into normal.

Operating control

Set upper level Umax in range 138 - 276 V (or 240 - 480 V for HRN-43) and lower level Umin in range 35-99 % Umax. In case any phase passes this range, after a delay which eliminated short voltage peaks, contact opens. Output contact again switches after returning back into monitored voltage range and exceeding fixed hysteresis (which is adjustable in two values by DIP switch). In case of failure of two or three phases, the relay is deactivated immediately regardless of the set delay t2.

Phase sequence

Monitors correctness of phase sequence. In case of unwanted change output contact breaks. In case of energization of a device with incorrect phase sequence, contact stays opened.

Asymmetry

Rate of asymmetry between individual phases is set in a range of 5-20 %. In case set asymmetry is exceeded, output relay breaks and LED indicating asymmetry shines. Delays t1, t2 and hysteric are applicable when returning to normal state. Monitoring asymmetry can be switched off by DIP switch ASYM.



- It serves to monitor voltage, phase failure and sequence in switchboards, protection of devices in 3-phase mains.
- It is possible to set upper and lower level of monitoring voltage.
- Adjustable time delay eliminates short voltage peaks and failures in the main.
- Supplied from monitored voltage.
- Faulty state is indicated by red LED and by opening of output relay contact.
- Output contact 1x changeover / SPDT 8 A / 250 V AC1.
- In case supply voltage falls below 60 %Un (U_{OFF} lower level) relay immediately opens without delay.
- **HRN-54:** supply from all phases which means that relay is functional also in case when one phase is faulty.
- **HRN-54N:** supply L1, L2, L3-N, means that relay monitors also failure of neutral wire.
- 1-MODULE, DIN rail mounting.

Description

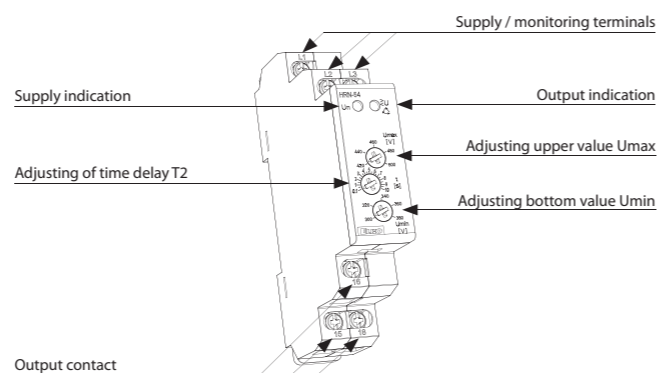

Function

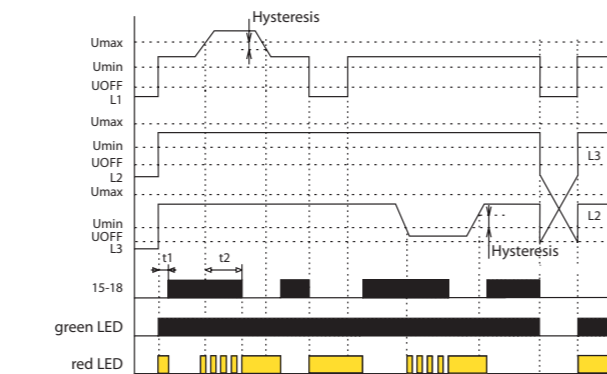

Connection

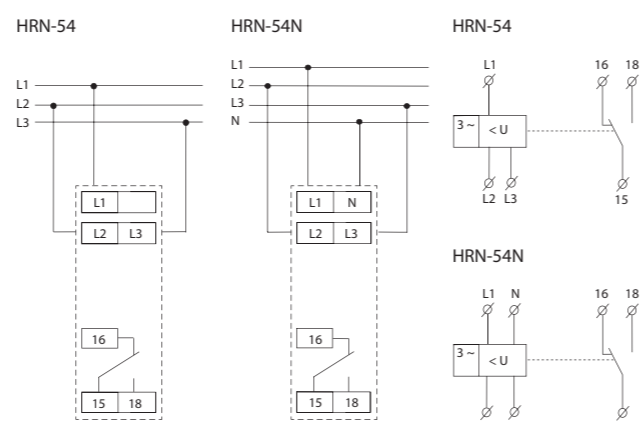

Symbol

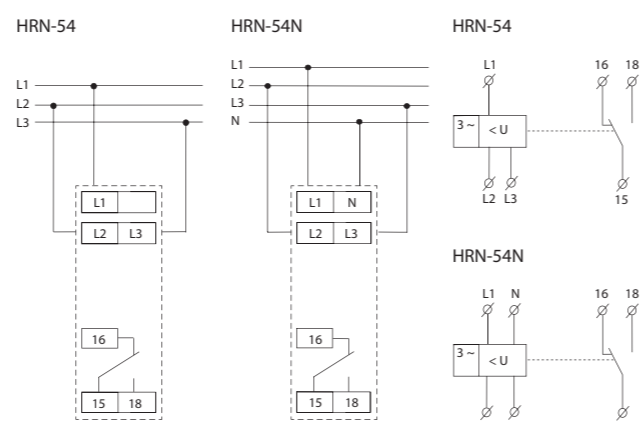

EAN code
HRN-54: 8595188137201
HRN-54N: 8595188137218

Technical parameters	HRN-54	HRN-54N
Supply and measuring:	L1, L2, L3	L1, L2, L3, N
Supply terminals:	L1, L2, L3	L1, L2, L3, N
Supply / measured voltage:	3x 400 V / 50-60 Hz	3x 400 V / 230 V / 50-60 Hz
Burden:	max. 2 VA / 1 W	
Max. dissipated power (Un + terminals):	1 W	
Level Umax:	105 - 125 % Un	
Level Umin:	75 - 95 % Un	
Hysteresis:	2 %	
Max. permanent overload:	AC 3x 460 V	AC 3x 265 V
Peak overload <1ms:	AC 3x 500 V	AC 3x 288 V
Time delay T1:	max. 500 ms	
Time delay T2:	adjustable 0.1-10 s	
Output		
Number of contacts:	1x changeover / SPDT (AgNi / Silver Alloy)	
Current rating:	8 A / AC1	
Breaking capacity:	2000 VA / AC1, 240 W / DC	
Inrush current:	10 A	
Switching voltage:	250 V AC1 / 24 V DC	
Indication of state:	red LED	
Mechanical life:	1x10 ⁷	
Electrical life (AC1):	1x10 ⁵	
Other information		
Operating temperature:	-20 °C to 55 °C (-4 °F to 131 °F)	
Storage temperature:	-30 °C to 70 °C (-22 °F to 158 °F)	
Electrical strength:	4 kV (supply - output)	
Operating position:	any	
Mounting:	DIN rail EN 60715	
Protection degree:	IP40 from front panel / IP10 terminals	
Overvoltage category:	III.	
Pollution degree:	2	
Max. cable size (mm ²):	solid wire max. 2x 2.5 or 1x 4 / with sleeve max. 1x 2.5 or 2x 1.5 (AWG 12)	
Dimensions:	90 x 17.6 x 64 mm (3.5 x 0.7 x 2.5")	
Weight:	67 g (2.36 oz.)	66 g (2.33 oz.)
Standards:	EN 60255-6, EN 61010-1	

Function description

Relay in 3-phase main monitors size of phase voltage. It is possible to set two independent voltage levels and thus it is possible to set two independent voltage levels and monitor e.g. undervoltage and overvoltage independently. In normal state when voltage is within set levels, output relay is closed and red LED shines. In case voltage exceeds or falls below the set levels, output relay opens and red LED shines (LED indicates faulty state - flashes when timing).

In case supply voltage falls below 60 % Un (U_{OFF} lower level) relay immediately opens without delay and faulty state is indicated by red LED.

In case timing is in progress and faulty state is indicated, timing is immediately stopped.



EAN code
HRN-55: 8595188137225
HRN-55N: 8595188137232

Technical parameters	HRN-55	HRN-55N
Monitoring terminals:	L1, L2, L3	L1, L2, L3, N
Supply terminals:	L1, L2, L3	L1, L2, L3, N
Voltage:	3x 400 V / 50-60 Hz	3x 400 V / 230 V / 50-60 Hz
Burden:	max. 2 VA / 1 W	
Max. dissipated power (Un + terminals):	1 W	
Level Umax:	125 % Un	
Level Umin:	75 % Un	
Hysteresis:	2 %	
Max. permanent:	AC 3x 460 V	AC 3x 265 V
Peak overload <1ms:	AC 3x 500 V	AC 3x 288 V
Time delay T1:	max. 500 ms	
Time delay T2:	adjustable 0.1 - 10 s	
Output		
Number of contacts:	1x changeover / SPDT (AgNi / Silver Alloy)	
Current rating:	8 A / AC1	
Breaking capacity:	2000 VA / AC1, 240 W / DC	
Inrush current:	10 A	
Switching voltage:	250 V AC1 / 24 V DC	
Output indication:	red LED	
Mechanical life:	1x10 ⁷	
Electrical life (AC1):	1x10 ⁵	
Other information		
Operating temperature:	-20 °C to 55 °C (-4 °F to 131 °F)	
Storage temperature:	-30 °C to 70 °C (-22 °F to 158 °F)	
Electrical strength:	4 kV (supply - output)	
Operating position:	any	
Mounting:	DIN rail EN 60715	
Protection degree:	IP40 from front panel / IP10 terminals	
Overvoltage category:	III.	
Pollution degree:	2	
Max. cable size (mm ²):	solid wire max. 2x 2.5 or 1x 4 / with sleeve max. 1x 2.5 or 2x 1.5 (AWG 12)	
Dimensions:	90 x 17.6 x 64 mm (3.5 x 0.7 x 2.5")	
Weight:	67 g (2.36 oz.)	65 g (2.29 oz.)
Standards:	EN 60255-6, EN 61010-1	

Function description

Relay in 3-phase main monitors correct phase sequence and failure of any phase. Green LED is permanently ON and indicates presence of power supply voltage. In case of phase failure or exceeding voltage level red LED flashes and relay breaks. When changing to faulty state, time delay applies. Time delay setting is set by a potentiometer on front panel of the device. In case of incorrect phase sequence red LED shines permanently and relay is open. In case supply voltage falls below 60 % Un (OFF lower level) relay immediately opens with no delay and faulty state is indicated by red LED.

HRN-55 - thanks to supply from all phases, this relay is able to stay operational also if one phase is out.

HRN-55N -supply L1, L2, L3-N, means that relay monitor also failure in neutral wire.

- Relay monitors phase sequence and failure, exceeding of monitored voltage in 3 phase main.
- **HRN-55:** supply from all phases, which means that function of relay is applicable also if one phase fails.
- **HRN-55N:** supply L1, L2, L3-N, it means that relay also monitors break of neutral point.
- Fixed delay T1 (500 ms) and adjustable delay T2 (0.1 - 10 s).
- Faulty state is indicated by LED and output contact of relay is OFF.
- Output contact: 1x changeover / SPDT 16 A / 250 V AC1.
- 1-MODULE, DIN rail mounting.

Description

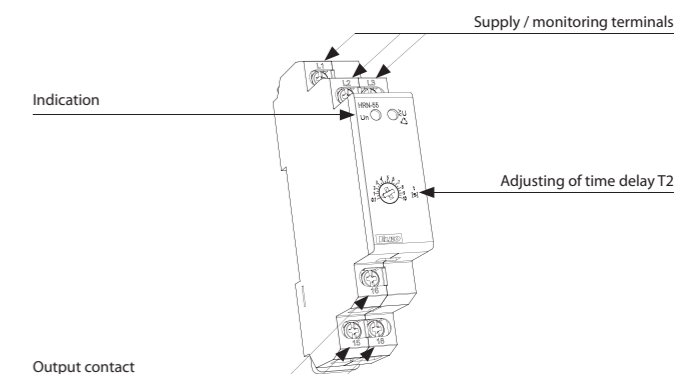

Function

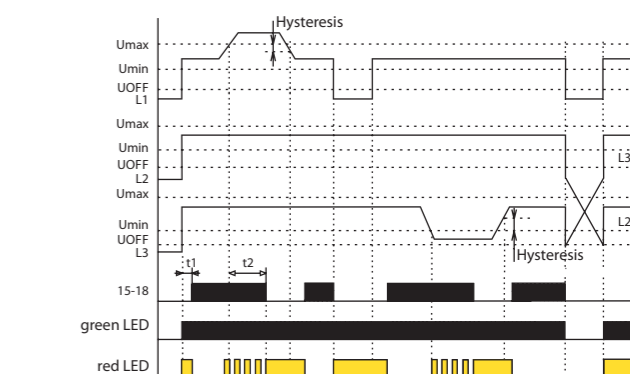

Connection

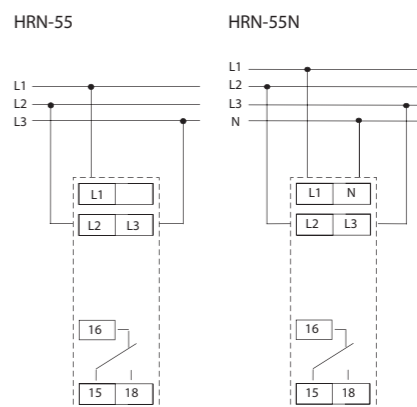

Symbol

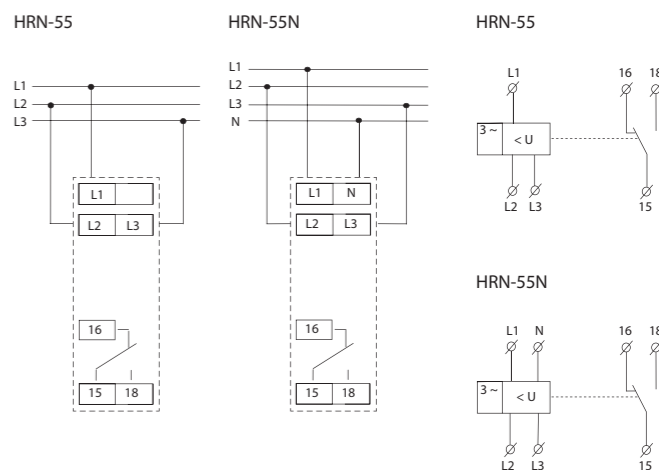



- Relay monitors phase sequence and failure (e.g. control of correct motor winding etc.).
- Relay is designated for monitoring of 3-phase networks.
- Supply from all phases which means that relay is functional also in case of one phase failure.
- Supply and monitored supply U_n :

1-MODUL	3-MODUL
HRN-56/120 - 3x 120 V	HRN-56/480 - 3x 480 V
HRN-56/208 - 3x 208 V	HRN-56/575 - 3x 575 V
HRN-56/240 - 3x 240 V	
HRN-56/400 - 3x 400 V	
- Fixed time delay T1 (500 ms) and adjustable time delay T2 (0 - 10s).
- Faulty state is indicated by LED and by opening of output relay contact.
- Output contact 1x changeover / SPDT 8 A / 250V AC1.
- 1-MODULE, 3-MODULE, DIN rail mounting.

EAN code
 HRN-56 /120V: 8595188130745
 HRN-56 /208V: 8595188130134
 HRN-56 /240V: 8595188137119
 HRN-56 /400V: 8595188137126
 HRN-56 /480V: 8595188130189
 HRN-56 /575V: 8595188130196

Technical parameters	HRN-56					
	120	208	240	400	480	575
Monitoring terminals:	L1, L2, L3					
Supply terminals:	L1, L2, L3					
Supply / measured voltage:	3x120 V L-L (3x69.3V L-N)	3x 208 V L-L (3x120V L-N)	3x 240 V L-L (3x139V L-N)	3x 400 V L-L (3x230V L-N)	3x 480 V L-L (3x277V L-N)	3x 575 V L-L (3x332V L-N)
Burden:	max. 2 VA / 1 W					
Max. dissipated power (Un + terminals):	2 W					
Level Umin:	adjustable 70 - 95 % Un					
Level Uoff:	60 % Un					
Hysteresis:	2 %					
Max. permanent overload:	AC 3x 160 V	AC 3x 276 V	AC 3x 460 V	AC 3x 550 V	AC 3x 660 V	AC 3x 660 V
Peak overload <1s:	AC 3x 180 V	AC 3x 300 V	AC 3x 500 V	AC 3x 600 V	AC 3x 700 V	AC 3x 700 V
Time delay T1:	max. 500 ms					
Time delay T2:	adjustable 0 - 10 s					
Output						
Number of contacts:	1x changeover / SPDT (AgNi / Silver Alloy)					
Current rating:	8 A / AC1					
Breaking capacity:	2000 VA / AC1, 240 W / DC					
Inrush current:	10 A					
Switching voltage:	250 V AC1 / 24 V DC					
Indication of state:	red LED					
Mechanical life:	1x10 ⁷		3x10 ⁷			
Electrical life (AC1):	1x10 ⁵					
Other information						
Operating temperature:	-20 °C to +55 °C (-4 °F to 131 °F)					
Storage temperature:	-30 °C to +70 °C (-22 °F to 158 °F)					
Electrical strength:	4 kV (supply - output)					
Operating position:	any					
Mounting:	DIN rail EN 60715					
Protection degree:	IP40 from front panel / IP10 terminals		IP40 from front panel / IP20 terminals			
Oversvoltage category:	III.		max.1x 2.5, max. 2x 1.5 / with sleeve max. 1x 1.5 (AWG 12)			
Pollution degree:	2					
Max. cable size (mm ²):	solid wire max. 2x 2.5 or 1x 4 / with sleeve max. 1x 2.5 or 2x 1.5 (AWG 12)					
Dimensions:	90 x 17.6 x 64 mm (3.5 x 0.7 x 2.5")			90 x 52 x 65 mm (3.5 x 2 x 2.6")		
Weight:	65 g (2.3 oz)	65 g (2.3 oz)	65 g (2.3 oz)	66 g (2.3 oz)	110 g (3.9 oz)	110 g (3.9 oz)
Standards:	EN 60255-6, EN 61010-1					

Function description

Relay in 3-phase main monitors correct phase sequence and phase failure. Green LED illuminates permanently and indicates energization. In case of phase failure red LED flashes and relay turns off. When changing to faulty state, time delay applies - delay setting is done by potentiometer on the front panel of the device. In case of incorrect phase sequence, red LED shines permanently and relay is open. In case supply voltage falls below 60% U_n (U_{off} lower level) relay immediately opens with no delay and faulty state is indicated by red LED.

HRN-56: Thanks to supply from all phases, relay is functional also in case of one phase failure.

Description

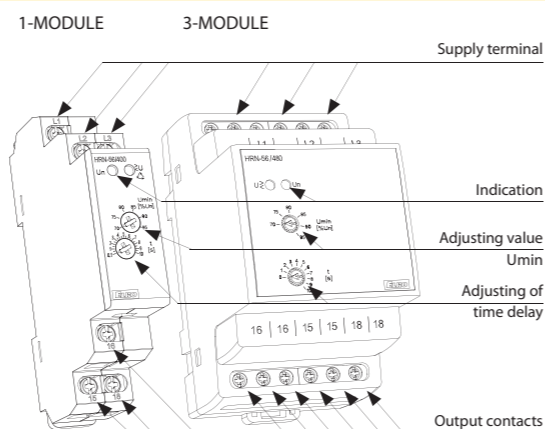

Function

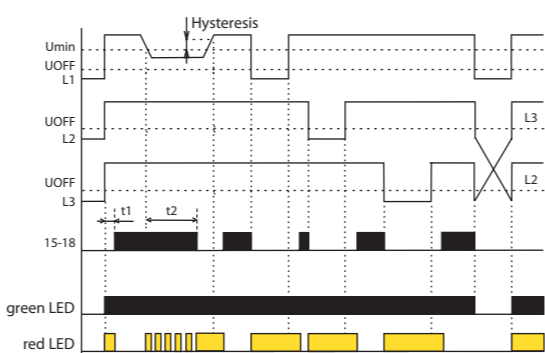

Connection

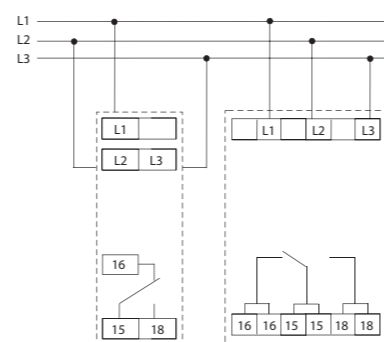

Symbol

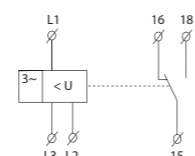

EAN code
 HRN-57: 8595188137256
 HRN-57N: 8595188137249

Technical parameters	HRN-57	HRN-57N
	Monitoring terminals:	L1, L2, L3
Supply terminals:	L1, L2, L3	L1, L2, L3, N
Voltage:	3x 400 V / 50-60 Hz	3x 400 V / 230 V / 50-60 Hz
Burden:	max. 2 VA / 1 W	
Max. dissipated power (Un + terminals):	2 W	
Level Umax:	105 - 125 % Un	
Level Umin:	75 - 95 % Un	
Hysteresis:	2 %	
Max. permanent overload:	AC 3x 460 V	AC 3x 265 V
Peak overload <1ms:	AC 3x 500 V	AC 3x 288 V
Time delay T1:	max. 500 ms	
Time delay T2:	adjustable 0.1-10 s	
Output		
Number of contacts:	1x changeover / SPDT (AgNi / Silver Alloy)	
Current rating:	8 A / AC1	
Breaking capacity:	2000 VA / AC1, 240 W / DC	
Inrush current:	10 A	
Switching voltage:	250 V AC1 / 24 V DC	
Output indication:	red LED	
Mechanical life:	1x10 ⁷	
Electrical life (AC1):	1x10 ⁵	
Other information		
Operating temperature:	-20 °C to 55 °C (-4 °F to 131 °F)	
Storage temperature:	-30 °C to 70 °C (-22 °F to 158 °F)	
Electrical strength:	4 kV (supply - output)	
Operating position:	any	
Mounting:	DIN rail EN 60715	
Protection degree:	IP40 from front panel / IP10 terminals	
Oversvoltage category:	III.	
Pollution degree:	2	
Max. cable size (mm ²):	solid wire max. 2x 2.5 or 1x 4 / with sleeve max. 1x 2.5 or 2x 1.5 (AWG 12)	
Dimensions:	90 x 17.6 x 64 mm (3.5" x 0.7" x 2.5")	
Weight:	67 g (2.4 oz.)	65 g (2.3 oz.)
Standards:	EN 60255-6, EN 61010-1	

Function description

Relay in 3-phase main monitors size of phase voltage. It is possible to set two independent voltage levels and thus it is possible to set two independent voltage levels and monitor e.g. undervoltage and overvoltage independently. In normal state when voltage is within set levels, output relay is closed and red LED shines. In case supply voltage falls below 60% U_n (U_{off} lower level) relay immediately breaks without delay and faulty state is indicated by red LED. In case voltage exceeds or falls below the set levels, output relay breaks and red LED shines (LED indicates faulty state - flashes when timing).

In case timing is in progress and faulty state is indicated, timing is immediately stopped.

- It serves to monitor voltage in a switchboard, protection of devices in 3-phase main.
- It monitors value of voltage in 3-phase main.
- It is possible to set upper and lower level independently.
- Adjustable time delay eliminated short voltage peaks and failures in the main.
- The device is supplied from monitored voltage.
- Faulty state is indicated by red LED and by breaking output relay contact.
- Output contact 1x changeover / SPDT 8 A / 250 V AC1.
- Relay doesn't monitor phase sequence.
- HRN-57:** supply from all phases, means that relay is functional also in case of failure in one phase.
- HRN-57N:** supply L1, L2, L3-N, means that relay monitors also failure of neutral wire.
- 1-MODULE, DIN rail mounting.

Description

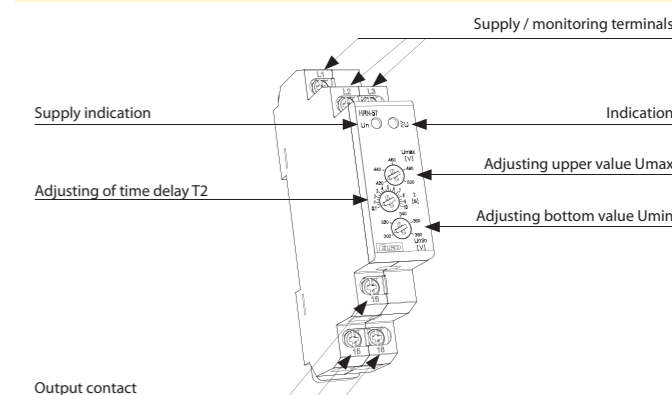

Function

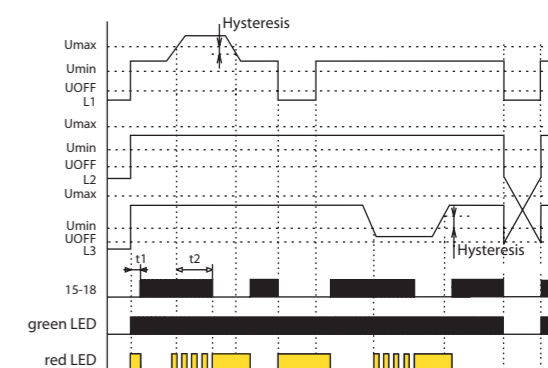

Connection

HRN-57

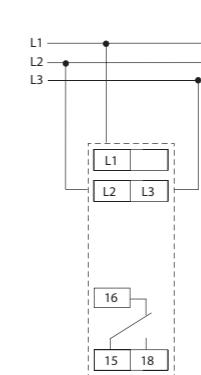

HRN-57N

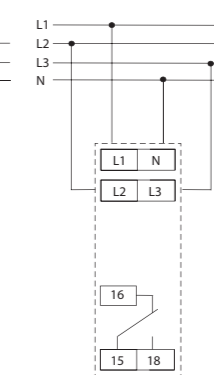

Symbol

HRN-57

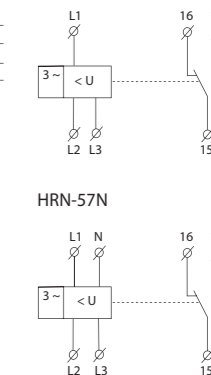

HRN-57N

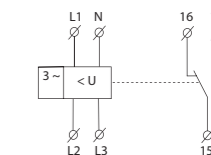



- Used for optical signaling of the voltage level in three phases.
- Each phase features LED signaling broken is divided by color into voltage levels:
 - voltage in tolerance of $\pm 15\%$ - green
 - overvoltage - red
 - undervoltage - yellow
 - voltage $< 50\text{ V}$ - LED not illuminated.
- Four-wire connection - L1, L2, L3, N.
- Monitors phase voltages against neutral wire.
- Not dependent upon order of phases.
- Four-wire connection - L1, L2, L3, N.
- In 1-MODULE design, DIN rail mounting.

Description of device

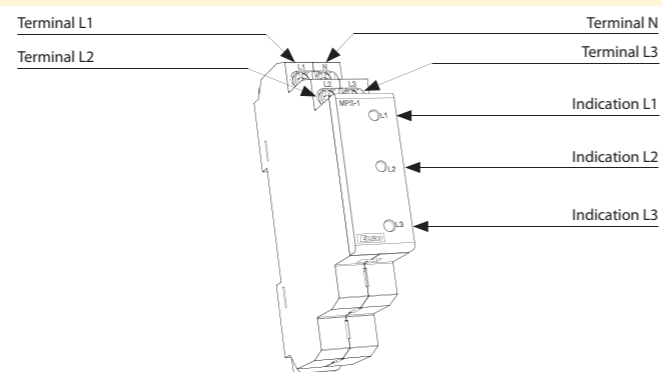

Function

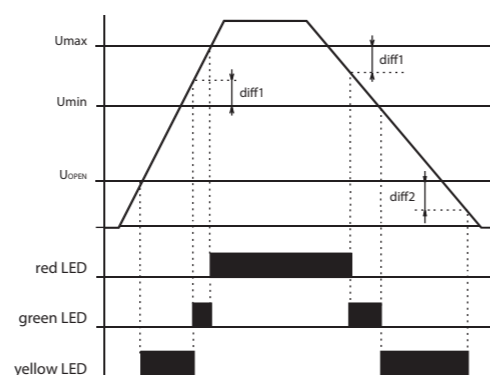

After connecting the supply voltage, the LED illuminates - the color corresponds to the voltage size of individual phases. If the phase voltage drops under 40 V (phase outage), the corresponding LED is not illuminated.

Connection

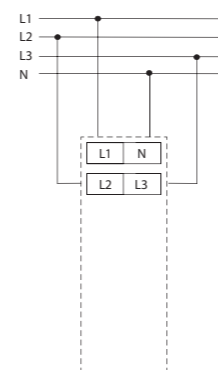

EAN code
MPS-1: 8595188145978

Technical parameters		MPS-1
Supply voltage:	AC 3x 400/230 V / 50 - 60 Hz	
Supply voltage tolerance:	+20 %, -75 %	
Power consumption:	max. 1 VA / 0.5 W	
Indication		
LED not illuminated:	0.. 50 V / 45.. 0 V	
LED illuminated		
- yellow:	50.. 207 V / 195.5.. 45 V	
- green:	207.. 264.5 V / 253.. 195.5 V	
- red:	264.5.. 276 V / 276.. 253 V	
Other information		
Design:	1 MODULE	
Mounting:	DIN rail EN60715	
Operating position:	any	
Coverage:	panel IP40, terminals IP10	
Overtoltage category:	III.	
Contamination level:	2	
Max. cable size (mm ²):	solid wire max. 2x 2.5 or 1x 4 / with sleeve max. 1x 2.5 or 2x 1.5 (AWG 12)	
Working temperature:	-20 °C to 55 °C (-4 °F to 131 °F)	
Storage temperature:	-30 °C to 70 °C (-22 °F to 158 °F)	
Dimensions:	90 x 17.6 x 64 mm (3.5 x 0.7 x 2.5")	
Weight:	48 g (1.7 oz.)	
Standards:	EN60947-1, EN60947-5-1	



EAN code
HRF-10: 8595188144827

Technical parameters		HRF-10
Supply and monitoring terminals:	L, N	
Supply voltage:	161 - 346 V	
Rated frequency Fn:	50 / 60 / 400 Hz	
Burden (max):	1.7 VA / 1.1 W	
Max. dissipated power (Un + terminals):	2 W	
Overload capacity		
- continuous:	346 V	
- max.10 s:	416 V	
Frequency Fmax:	adjustable 80 - 120 % Fn	
Frequency Fmin:	adjustable 80 - 120 % Fn	
Difference:	adjustable 0.5 - 5 % Fn	
Delay (until failure):	adjustable 0.5 - 10 s	
Opening level (Uopen):	161 V	
Output relay - contact:	2x changeover / SPDT (AgNi) gilded	
AC contact capacity:	250 V / 8 A, max. 2000 VA	
DC contact capacity:	30 V / 8 A	
Mechanical life:	3x10 ⁶ at rated load	
Other information		
Operational temperature:	-20 °C to 55 °C (-4 °F to 131 °F)	
Storing temperature:	-30 °C to 70 °C (-22 °F to 158 °F)	
Electrical strength (supply - relay contact):	4 kV / 1 min.	
Protection degree:	III.	
Overtoltage category:	2	
Pollution degree:	IP40 from front panel / IP20 terminals	
Profile of connecting wires (mm ²):	max. 2x 1.5 / 1x 2.5 (AWG 12)	
Dimensions:	90 x 52 x 64 mm (3.5 x 2 x 2.6")	
Weight:	127 g (4.5 oz.)	
Standards:	EN 60255-6, EN 60255-27, EN 61000-6-2, EN 61000-6-4	

Connection

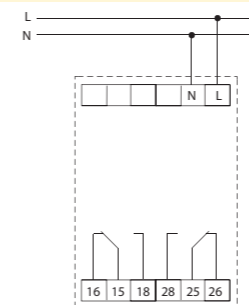

Rated frequency setting

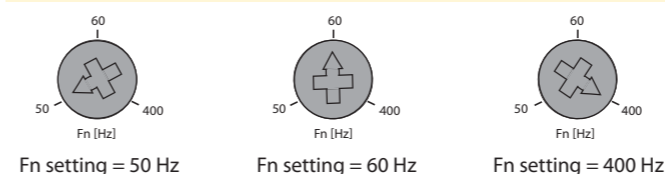

- The relay serves to monitor frequency of AC voltage, e.g. in photovoltaic power stations, generators.
- The monitored frequency 50 / 60 / 400 Hz is selected by a switch.
- Supplied from monitored voltage.
- Two adjustable levels of frequency (Fmin, Fmax) in the range of 80 - 120 % Fn.
- Adjustable difference level.
- Adjustable delay level.
- Switchable ranges of rated frequency Fn.
- 3-MODULE design, DIN rail mounting.

Device description

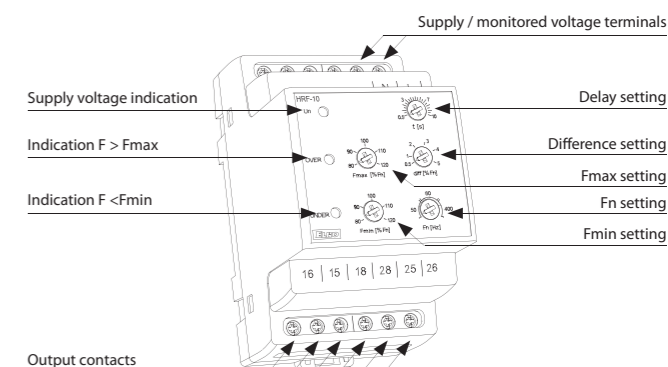

Functions

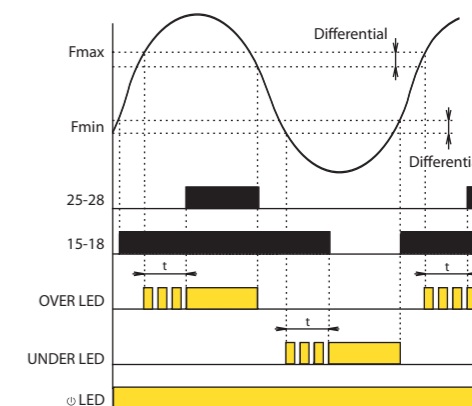

After the supply (monitored) voltage is connected, the green LED is on. If the value of the monitored frequency falls within the range between the two set levels Fmin - Fmax no red LED is on. The relay UNDER is triggered (contacts 15-16-18) and the relay OVER is disconnected (contacts 25-26-28).

If the monitored frequency exceeds the set level Fmax, the relay OVER is triggered after the set delay timing elapses and the red LED OVER goes on. The red LED flashes during the timing.

If the monitored frequency drops below Fmax - difference, the relay is activated without delay and the red LED OVER goes off.

If the monitored frequency drops below the set level Fmin, the relay UNDER is disconnected after the set delay timing elapses and the red LED UNDER goes on. The red LED flashes during the timing. If the monitored frequency exceeds the level Fmin + the difference, the relay is triggered without delay and the red LED UNDER goes off.

If the monitored voltage is lower than the opening level Uopen both the relays are disconnected and both the red LED (UNDER and OVER) start flashing slowly - indicating insufficient supply voltage.

INNOVATION



EAN code
 COS-2/230V: 8595188155434
 COS-2/110V: 8595188152280
 COS-2/400V: 8595188152365
 COS-2/24V: 8595188155441

Technical parameters	COS-2
Supply	
Supply terminals:	A1 - A2
Voltage range:	AC 230 V, AC 110 V, AC 400 V or AC/DC 24 V (AC / 50 - 60 Hz)
Burden max.:	2.5 W / 5 VA (AC 110 V, AC 230 V, AC 400 V), 1.4 W / 2 VA (AC/DC 24 V)
Max. dissipated power (Un + terminals):	4 W
Operating range:	-15 %; +10 %
Measuring	
Voltage set:	3x 400 V / 230 V / 50 - 60 Hz
Terminals:	L1, L2, L3, B1
Upper level cos-φ:	adjustable 0.1 - 0.99
Bottom level cos-φ:	adjustable 0.1 - 0.99
Max. permanent voltage:	(input L1, L2, L3) AC 3x 460 V
Current range:	0.1 - 16 A
Current overloading:	20 A (< 3 sec.)
Hysteresis:	adjustable 5 % or 10 %
Time delay t1:	adjustable 0.1 - 10 s
Time delay t2:	adjustable 0.1 - 10 s
Accuracy	
Accuracy setting (mechanical):	5 %
Accuracy of repetition:	< 1 %
Temperature dependance:	< 0.1 % / °C (°F)
Limit values tolerance:	5 %
Output	
Number of contacts:	2x changeover/ SPDT (AgNi / Silver Alloy)
Current rating:	16 A / AC1
Breaking capacity:	4000 VA / AC1, 384 W / DC
Inrush current:	20 A / < 3 s
Switching voltage:	250 V AC1 / 24 V DC
Output indication:	yellow LED
Mechanical life:	3x10 ⁷
Electrical life (AC1):	0.7x10 ⁵
Other information	
Operating temperature:	-20 °C to 55 °C (-4 °F to 131 °F)
Storage temperature:	-30 °C to 70 °C (-22 °F to 158 °F)
Electrical strength:	4 kV (supply - output)
Operating position:	any
Mounting:	DIN rail EN 60715
Protection degree:	IP40 from front panel / IP20 terminals
Overvoltage category:	III.
Pollution degree:	2
Max. cable size (mm ²):	max. 1x 2.5, max. 2x1.5 / with sleeve max. 1x 1.5 (AWG 12)
Dimensions:	90 x 52 x 65 mm (3.5 x 2 x 2.6")
Weight:	243 g / 8.6 oz (230 V, 110 V, 400 V); 141 g / 5 oz (24 V)
Standards:	EN 60255-6, EN 61010-1

- Relay monitors phase shift between current and voltage in 3-phase or 1-phase networks - evaluates COS φ (replacement COS-1)
- The relay is designed to monitor overload / relieve the motors
- Relay is designed for 3 x 400 / 230V circuits
- Galvanically isolated power supply AC 230V, AC 110V, AC 400V or AC / DC 24V
- Adjustable upper and lower level COS φ
- Possibility to extend the current range using a current transformer
- Adjustable MEMORY function
- Two output relays (for each level independent)
- Adjustable delay eliminating engine start-up
- Output contact 2x changeover 16A / 250V AC1
- 3-MODULE design, mounting onto DIN rail.

Description

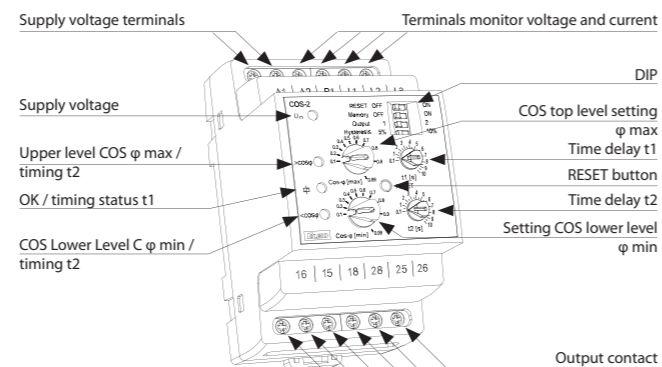

Description and importance of DIP switches

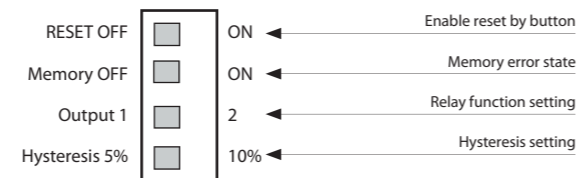

Connection

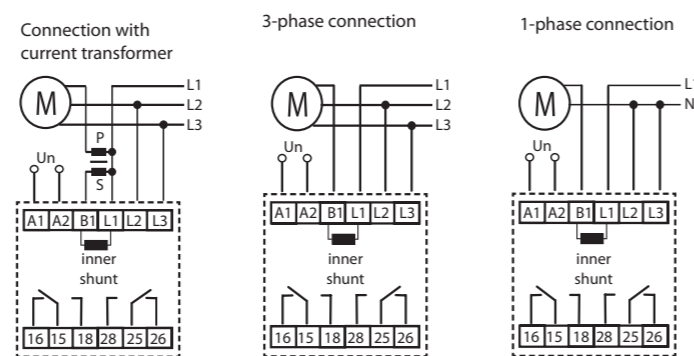

Symbol

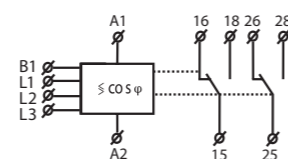

Function

Status after switching on power, two relay mode

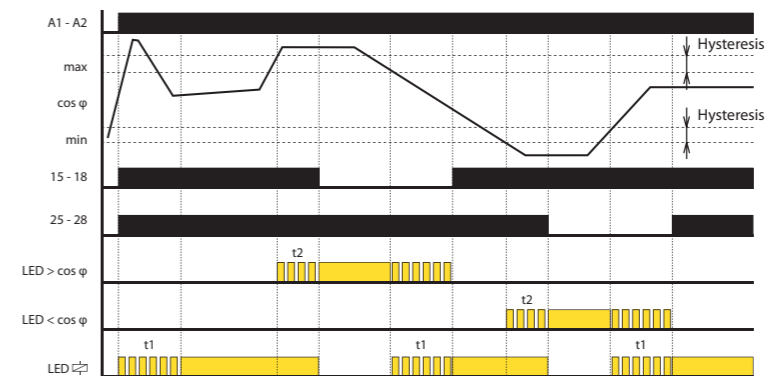

Memory on, two relay mode

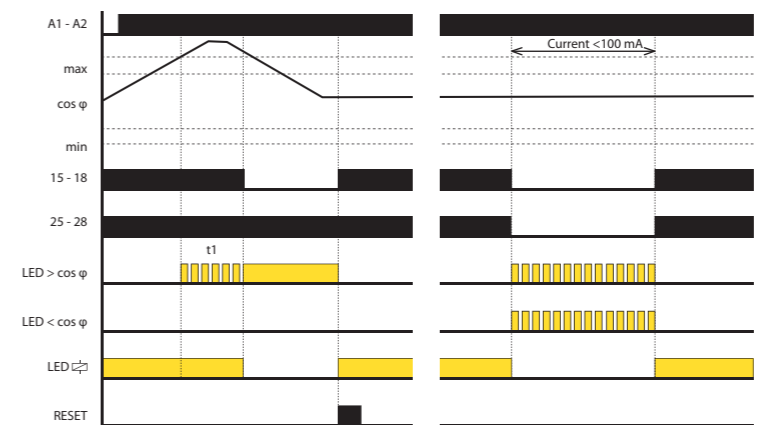

decrease (loss) of current

After powering on, the device sets the delay time t1 and yellow LED flashes. Both relays are switched on. The delay serves to eliminate a faulty state when starting the motor. After the time delay t1 begins monitoring COS φ only.

If the COS φ is in the band between the upper and lower limits set, both relays are switched on and the yellow LED is on.

If the COS φ is outside the set limits (> COS φ max or < COS φ min), an error condition occurs - the time t2 is delayed while the red LED corresponding to the COS φ blinks at the same time. After the time delay t2 red LED lights and the corresponding relay remains off.

When the COS φ returns to set limits, the time t1 is delayed and the yellow LED flashes at the same time as the corresponding red LED. After the time delay stops blinking yellow LED, the corresponding red LED turns off and the relay switches on.

At low wattage (<100mA) or with a power failure, an error is reported by the simultaneous blinking of both red LEDs. After resuming the voltage or the current being watched, the relay returns to the normal state where the COS φ value is monitored.

When the memory is turned off (DIP switch 2 OFF) and the allowable reset (DIP switch 1 ON), the pressing state is reached after the power is turned on, i.e. flashing yellow LED, both relays are switched on, with time delay t1.

When the memory (DIP switch 2 ON) is in an error state (high or low value for cos φ) it should be reset (by pressing the RESET button).



- Current transformer is a part of the product. Inside this transformer there is a wire which senses the volume of flowing current.
- This construction reduces thermal stress of product when compared with conventional solutions with inbuilt shunt, and increases current range up to 20 Amps, and galvanically separates monitored circuit.
- For heating bars in sliding rails, heating cables, indication of current flow, controlling of 1-phase motor consumption...
- Universal supply AC 24 - 240 V and DC 24 V.
- Supply is galvanically separated from measuring current.
- Current exceeding - current flowing through monitored wire must not exceed 100 A.
- Output contact: 1x changeover / SPDT 8 A.
- Clamp terminals.
- 1-phase, 1-MODULE, DIN rail mounting.

Description

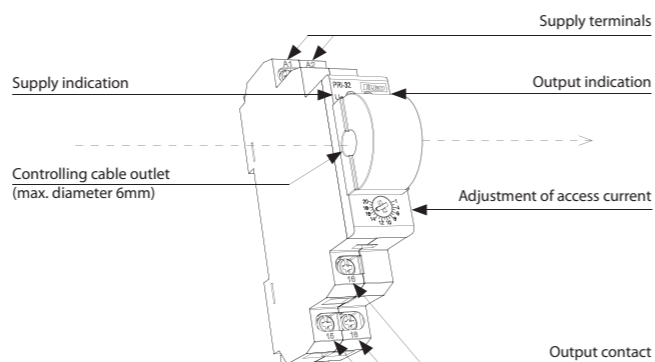

Function

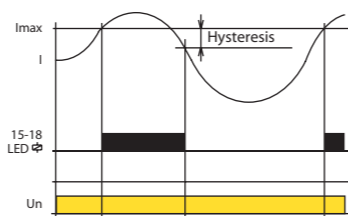

Monitoring relay PRI-32 serves to monitor current level in single phase AC circuits. Due to its fluent adjustment of release current, it is predestined for applications with necessity of current flow indication, and can be used as precedence relay. Output relay is off in normal state. In case the set current level is exceeded, it switches. Multivoltage supply is an advantage.

Connection



Symbol

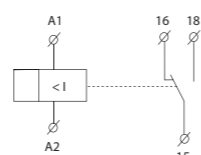

EAN code
PRI-32: 8595188121965

Technical parameters		PRI-32
Supply circuit		
Supply terminals:	A1 - A2	
Voltage range:	AC 24 - 240 V, DC 24 V (AC 50 - 60 Hz)	
Burden:	max. 1.5 VA / 1 W	
Max. dissipated power (Un + terminals):	2 W	
Operating range:	-15 %; +10 %	
Measuring circuit		
Current range:	1 - 20 A (AC 50 Hz)	
Current adjustment:	potentiometer	
Accuracy		
Setting accuracy (mech.):	5 %	
Repeat accuracy:	< 1 %	
Temperature dependency:	< 0.1 % / °C (°F)	
Limit values tolerance:	5 %	
Overload capacity:	max. 100 A / 10 s	
Output		
Number of contacts:	1x changeover / SPDT (AgNi / Silver Alloy)	
Current rating:	8 A / AC1	
Breaking capacity:	2000 VA / AC1, 240 W / DC	
Output indication:	red LED	
Other information		
Operating temperature:	-20 °C to 55 °C (-4 °F to 131 °F)	
Storage temperature:	-30 °C to 70 °C (-22 °F to 158 °F)	
Electrical strength:	4 kV (supply - output)	
Operating position:	any	
Mounting:	DIN rail EN 60715	
Protection degree:	IP40 from front panel / IP10 terminals	
Overvoltage category:	III.	
Pollution degree:	2	
Max. cable size (mm ²):	solid wire max. 2x 2.5 or 1x 4, with sleeve max. 1x 2.5 or 2x 1.5 (AWG 12)	
Dimensions:	90 x 17.6 x 80.5 mm (3.5" x 0.7" x 3.2")	
Weight:	75 g (2.6 oz.)	
Standards:	EN 60255-6, EN 61010-1	



EAN code
PRI-51/0.5A: 8595188142885
PRI-51/1A: 8595188124904
PRI-51/2A: 8595188124911
PRI-51/5A: 8595188124928
PRI-51/8A: 8595188124935
PRI-51/0.1-10A: 8595188155717
PRI-51/10A: 8595188148917
PRI-51/16A: 8595188124942

Technical parameters

Supply circuit		PRI-51
Supply terminals:	A1 - A2	
Voltage range:	AC 24 - 240 V and DC 24 V (AC 50 - 60 Hz)	
Burden:	max. 25 VA / 1.6 W	
Max. dissipated power (Un + terminals):	2.5 W	
Supply voltage tolerance:	-15 %; +10 %	

Measuring circuit		between B1 - B2
Load:	between B1 - B2	
Current range:	PRI-51/0.5A: AC 0.05-0.5A	PRI-51/10A: AC 1-10A
	PRI-51/1A: AC 0.1-1A	PRI-51/0.1-10A: AC 0.1-10 A
	PRI-51/2A: AC 0.2-2A	PRI-51/16A: AC 1.6-16A
	PRI-51/5A*: AC 0.5-5A	(AC 50 Hz)
	PRI-51/8A: AC 0.8-8A	

Max. permanent current:	PRI-51/0.5A: 2 A
	PRI-51/1A: 4 A
	PRI-51/2A: 8 A
	PRI-51/0.1-10A: 10A
	PRI-51/5A, PRI-51/8A, PRI-51/10A, PRI-51/16A: 17 A
Inrush overload <1ms:	100 A
Current adjustment:	potentiometer
Time delay:	adjustable 0.5 - 10 s

Accuracy	
Setting accuracy (mechanical):	5 %
Repeat accuracy:	< 1 %
Temperature dependency:	< 0.1 % / °C (°F)
Limit values tolerance:	5 % (10 % for 0.05 - 0.5 A and 0.1 - 10 A range)
Hysteresis (fault to OK):	5 %

Number of contacts:	1x changeover / SPDT (AgNi / Silver Alloy)
Current rating:	8 A / AC1
Breaking capacity:	2000 VA / AC1, 240 W / DC
Output indication:	green / red LED

Other information	
Operating temperature:	-20 °C to 55 °C (-4 °F to 131 °F)
Storage temperature:	-30 °C to 70 °C (-22 °F to 158 °F)
Electrical strength:	4 kV (supply - output)
Operating position:	any
Mounting:	DIN rail EN 60715
Protection degree:	IP40 from front panel / IP10 terminals
Overvoltage category:	III.
Pollution degree:	2
Max. cable size (mm ²):	solid wire max. 2x 2.5 or 1x 4, with sleeve max. 1x 2.5 or 2x 1.5 (AWG 12)
Dimensions:	90 x 17.6 x 64 mm (3.5" x 0.7" x 2.5")
Weight:	72 g (2.5 oz.)
Standards:	EN 60255-6, EN 61010-1

* applicable also for current transformer

- It serves for monitoring of heating in rail-switches, heating cables, consumption of one-phase motors, indicates current flow
- Flexible adjustment by potentiometer, choice of 8 ranges: AC 0.05 - 0.5 A; AC 0.1 - 1 A; AC 0.2 - 2 A; AC 0.5 - 5 A; AC 0.8 - 8 A; AC 0.1 - 10 A; AC 1 - 10 A; AC 1.6 - 16 A
- Adjustable delay 0.5 - 10 s to eliminate short current peaks
- It is possible to use for current scanning from current transformer - up to 600 A!
- Universal supply AC 24 - 240 V and DC 24 V
- Supply is galvanically separated from measured current, it must be in the same phase
- Output contact: 1x changeover / SPDT 8 A
- 1-phase, 1-MODULE, DIN rail mounting

Description

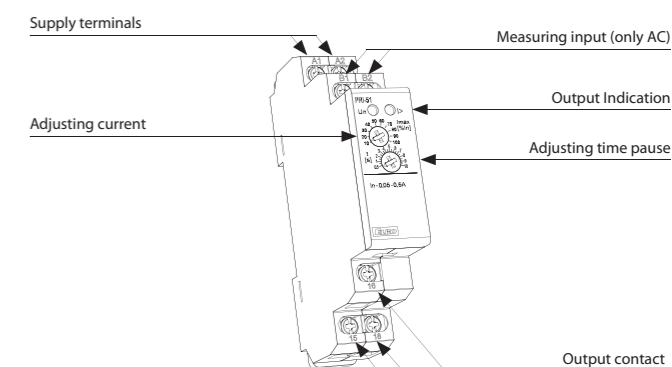

Function

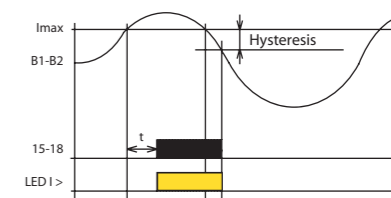

Monitoring relay PRI-51 serves to monitor current level in one-phase AC circuits. Gradual setting of actuating current of monitoring relay enables many different applications. Output relay is in normal state opened. After the set current level is reached, relay closes after the set delay (0.5 - 10s). When returning from faulty to normal state there is a hysteresis (5 %). Multi-voltage of this relay is an advantage. It is possible to monitor load which doesn't have the same supply as monitoring relay PRI-51.

Range of PRI-51 can be increased by an external current transformer.

Connection

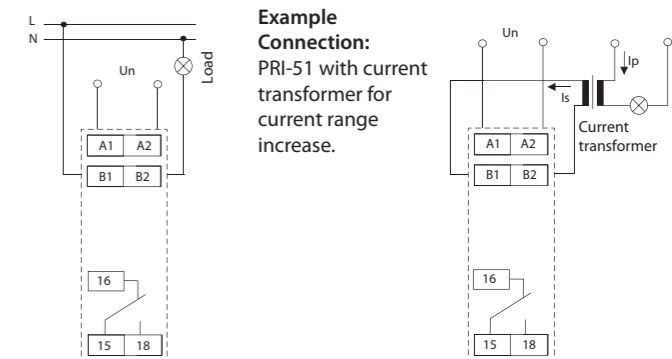

Symbol

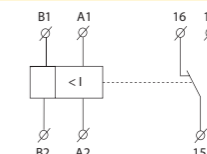

Example of an order

Always specify all reference name of current relay according to required range, for example PRI-51/5.



EAN code
 PRI-41/110V: 8595188140508
 PRI-41/230V: 8595188140485
 PRI-41/400V: 8595188147446
 PRI-41/24V: 8595188140492
 PRI-42/110V: 8595188140539
 PRI-42/230V: 8595188140515
 PRI-42/400V: 8595188147484
 PRI-42/24V: 8595188140522

Technical parameters	PRI-41	PRI-42
Supply circuit		
Supply terminals:	A1 - A2	
Voltage range:	AC 110 V, AC 230 V, AC 400 V or AC / DC 24 V (AC 50 - 60 Hz)	
Burden max.:	2.5 W / 5 VA (AC 110 V, AC 230 V, AC 400 V), 1.4 W / 2 VA (AC/DC 24 V)	
Max. dissipated power (Un + terminals):	5.5 W (110 V, 230 V, 400 V) 4.5 W (24 V)	
Operating range:	-15 %; +10 %	
Measuring circuit		
Ranges*:	AC/DC 3.2 - 16 A (AC 50 - 60 Hz)	AC/DC 1 - 5 A (AC 50 - 60 Hz)
Terminals:	C - B1	C - B2
Input resistance:	2.3 mΩ	11 mΩ
Max. permanent current:	16 A	8 A
Inrush overload <1ms:	20 A	16 A
Time delay for I _{max} :	adjustable 0.1-10 s	
Time delay for I _{min} :	adjustable 0.1-10 s	
Accuracy		
Measuring accuracy:	5 %	
Repeat accuracy:	< 1 %	
Temperature dependancy:	< 0.1 % / °C	
Limit values tolerance:	5 %	
Hysteresis (fault to OK):	selectable 5 % / 10 % from range	
Output		
Number of contacts:	2x changeover / SPDT (AgNi / Silver Alloy)	
Current rating:	16 A / AC1	
Breaking capacity:	4000 VA / AC1, 384 W / DC	
Inrush current:	30 A / < 3 s	
Switching voltage:	250 V AC1 / 24 V DC	
Output indication:	yellow LED	
Mechanical life:	3x10 ⁷	
Electrical life (AC1):	0.7x10 ⁶	
Other information		
Operating temperature:	-20 °C to 55 °C (-4 °F to 131 °F)	
Storage temperature:	-30 °C to 70 °C (-22 °F to 158 °F)	
Electrical strength:	4 kV (supply - output)	
Operating position:	any	
Mounting:	DIN rail EN 60715	
Protection degree:	IP40 from front panel / IP20 terminals	
Overvoltage category:	III.	
Pollution degree:	2	
Max. cable size (mm ²):	solid wire max. 1x 2.5 or 2x 1.5 / with sleeve max. 1x 1.5 (AWG 12)	
Dimensions:	90 x 52 x 65 mm (3.5" x 2" x 2.6")	
Weight:	248 g (8.7 oz.) (110 V, 230 V, 400 V); 145 g (5.1 oz.) (24 V)	
Standards:	EN 60255-6, EN 61010-1	

- used to monitor overloading / relief (machine, motor, etc.), check consumption, diagnostics on a remote device (burning, short circuit, increased current draw, etc.)
- relay designed for monitoring DC and AC currents in three ranges
- the relay controls the current size in two independent levels (I_{max}, I_{min})
- setting the monitored level I_{max} (in % of range)
- setting the monitored level I_{min} (in % of range - for PRI-42 - function WINDOW) (in % of the set upper limit - for PRI-41 - function HYSTERESIS)
- adjustable function "MEMORY"
- function of second relay (independently / in parallel)
- adjustable delay for eliminating short-term outages and surges for every level independently
- galvanically separated power supply from monitoring inputs
- output contact: 2x changeover 16 A / 250 V AC1 for each current level
- 3-MODULE, DIN rail mounting

Description

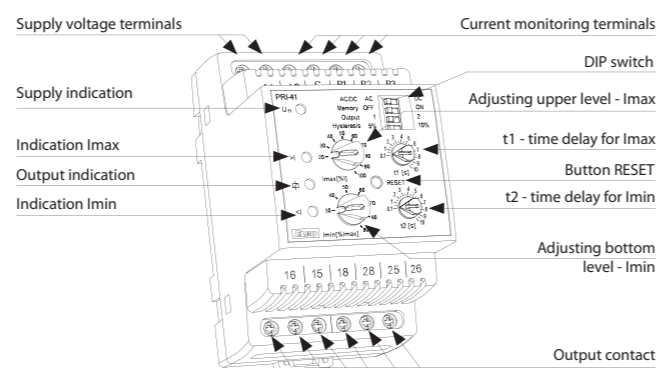

Description and importance of DIP switches

AC/DC AC	<input type="checkbox"/>	DC	← Measured AC / DC voltage
Memory OFF	<input type="checkbox"/>	ON	← Memory error state
Output 1	<input type="checkbox"/>	2	← Relay function setting
Hysteresis 5%	<input type="checkbox"/>	10%	← Hysteresis setting

Connection

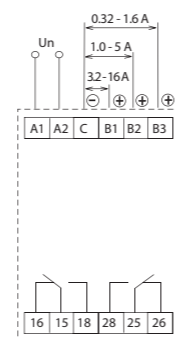

Symbol

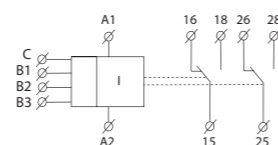

Function

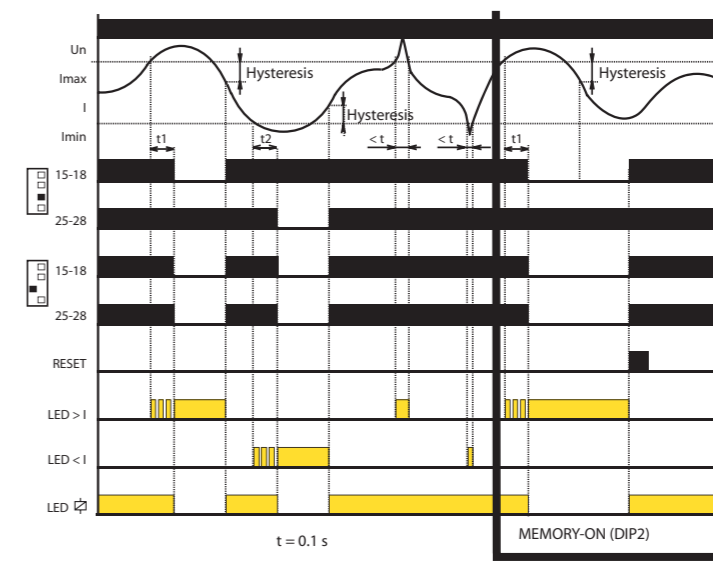

- if the value of the monitored current is in the zone between the set upper and lower levels, the status OK occurs - both relays are closed and the yellow LED illuminates. If the value of the monitored current is outside the set limits ($I > I_{max}$ or $I < I_{min}$), an error state occurs.
- when moving to an error state $I > I_{max}$, it times the delay t_1 and a red LED $> I$ simultaneously flashes. After the t_1 time elapses, the red LED $> I$ illuminates and the relevant relay opens.
- when moving to an error state $I < I_{min}$, it times the delay t_2 and a red LED $< I$ simultaneously flashes. After the time t_2 elapses, the red LED $< I$ illuminates and the relevant relay opens.
- when moving from the error status to the OK status, the relevant red LED immediately goes out, and the corresponding relay closes.

* Only one of the inputs can be connected.



- relay is designated for:
 - distant device diagnostic (short circuit, take-off increasing)
 - preferred (priority) relay - two appliances (boiler and floor heating) operating on one phase, but never run together - prevention against current overload and circuit breaker tripping. Enables to save your main breaker expenses.
 - current transit indicator - informs about heating activation, ceramic hob, ventilator...
 - changing over of appliances according to inverter's (converter) output by photocell applications
- NEW - hole for threaded conductor passes through the body of device
- part of device is current transformer, which is sensing size of current in threaded conductor
- possible to use also for sensing of current up to 600 A from external current transformer
- slight setting (by potentiometer) of tripping current - range AC 0.5.. 25 A
- slight setting (by potentiometer) of delay - adjustable in range 0.5.. 10 s
- supply voltage AC 230 V
- output contact 1x switching 8 A (AC1)
- 1-phase version, 1-MODULE, mounting onto DIN rail, saddle terminals

Description

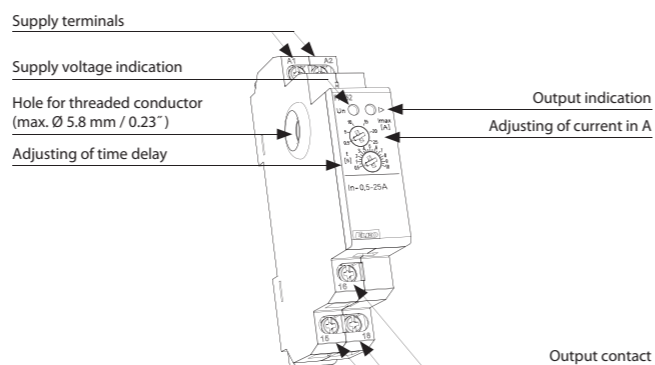

Functions

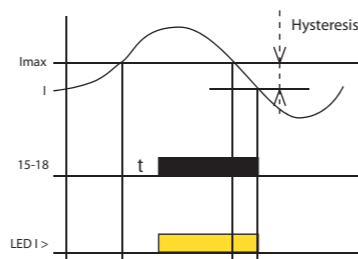

Monitoring relay PRI-52 serves for monitoring of current level in 1-phase AC circuits. Slight setting of release current level designates this relay for many various applications. Output relay is in normal status switched off. When set current level is overrun, relay get closed after preset delay. By return from error to normal status is used hysteresis.

PRI-52 range is possible to increase with external current transformer.

Advantage of PRI-52 is that the hole for threaded conductor is located under the level of covering in the switchboard - thanks that, threaded conductor is not accessible for unwanted manipulation.

Symbol

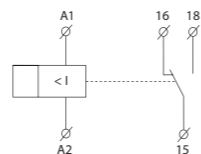

Connection example:
PRI-52 with current transformer for increasing of current range.

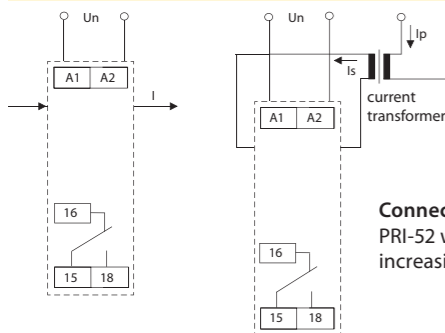

EAN code
PRI-53/1: 8595188142137
PRI-53/5: 8595188142144

Technical parameters	PRI-53/1	PRI-53/5
Supply terminals:	A1, A2	
Current monitoring terminals		
1st phase:	11, 12	
2nd phase:	13, 14	
3rd phase:	15, 16	
Supply voltage:	24 - 240 V AC/DC	
Tolerance of voltage range:	± 10 %	
Operating AC frequency:	45 - 65 Hz	
Burden: (max):	3 VA / 1.2 W	
Max. dissipated power (Un + terminals):	2.5 W	
Rated current In:	AC 1 A	AC 5 A
Current level - I:	adjustable 40 - 120 % In	
Overload capacity		
- continuous:	2 A	10 A
- max. 3s:	20 A	50 A
Difference:	fix 1 % In	
Delay (until failure):	adjustable 0.5 - 10s	
Output relay - contact:	2x changeover / SPDT (AgNi) gilded	
AC contact capacity:	250 V / 8 A, max. 2000 VA	
DC contact capacity:	30 V / 8 A	
Mechanical life:	3x10 ⁶ at rated load	
Other information		
Operating temperature:	-20 °C to 55 °C (-4 °F to 131 °F)	
Storing temperature:	-30°C to 70 °C (-22 °F to 158°F)	
Electrical strength (power supply - relay contact):	4 kV / 1 min.	
Overvoltage category:	III.	
Pollution level:	2	
Protection degree:	IP40 from front panel / IP20 terminal	
Max. cable size (mm ²):	max. 2x 1.5 / 1x 2.5 (AWG 12)	
Dimensions:	90 x 105 x 64 mm (3.5 x 4.1 x 2.5")	
Weight:	213 g (7.5 oz.)	
Standards:	EN 60255-6, EN 60255-27, EN 61000-6-2, EN 61000-6-4	

Connection

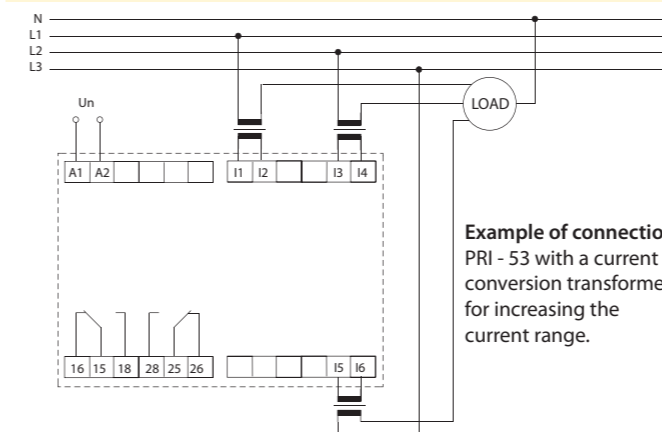

Example of connection:
PRI - 53 with a current conversion transformer for increasing the current range.

- It is intended for monitoring the current in three-phase devices (e.g. cranes, motors, etc.).
- 24 - 240 V AC/DC power supply galvanically separated from the circuit of the monitored current.
- Adjustable current level in % of In.
- Fixed difference level.
- Adjustable delay level (when exceeding the preset limit).
- Adjustable function:
 - UNDER - monitors the drop in the strength of current below the preset value (I).
 - OVER - exceeding the preset value (I).
- 2 types depending on the strength of rated current In (1 A, 5 A).
- 6-MODULE, DIN rail mounting.
- Output relay with 2 changeover contacts.
- Option of connecting via the current transformers to increase the value of the monitored current by up to 600 A.

Description

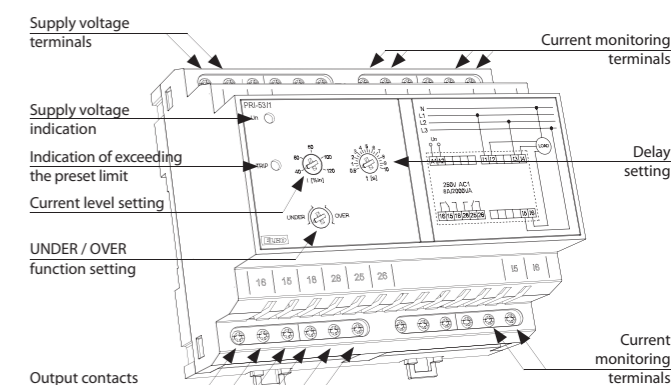

Functions

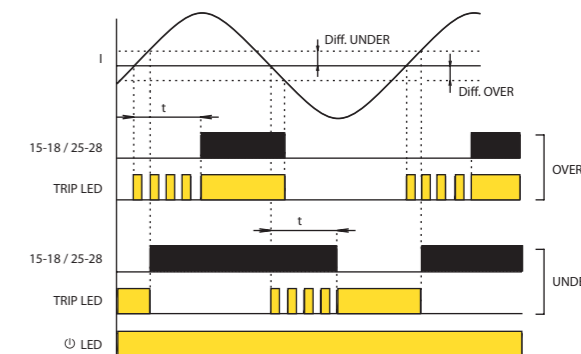

After the supply voltage is connected the green LED is on.

UNDER function:

If the strength of the monitored current in all phases exceeds the preset level I, the relay is triggered and the red LED is off. If the strength of the monitored current drops in any phase below the level I, the relay is disconnected after the preset delay timing elapses and the red LED goes on. The red LED flashes during the delay.

If the strength of the monitored current returns above the level I + difference, the relay is triggered without delay and the red LED goes off.

OVER function:

If the strength of the monitored current is lower in all phases than the preset level I, the relay is disconnected and the red LED is off.

If the strength of the monitored current exceeds in any phase the level I, the relay is triggered after the preset delay timing elapses and the red LED goes on. The red LED flashes during the delay.

If the strength of the monitored current again drops below the level I - difference, the relay is disconnected without delay and the red LED goes off.



- Relay is designed for monitoring levels in wells, basins, reservoirs, tanks...
- In one device you can choose the following configurations:
 - one-level switch of conductive liquids (by connecting H and D)
 - two-level switch of conductive liquids.
- One-state device monitors one level, two-state device monitors two levels (switches on one level and switches off on another level).
- Choice of function PUMP UP, PUMP DOWN.
- Adjustable time delay on the output (0.5 - 10s).
- Sensitivity adjustable by a potentiometer (5 - 100 kΩ).
- Measuring frequency 10 Hz prevents polarization of liquid and raising oxidation of measuring probes.
- Galvanically separated supply voltage UNI 24.. 240 V AC/DC.
- Output contact 1x changeover/SPDT 8A/250V AC1.
- 1-MODULE, mounting onto DIN rail.

Device description

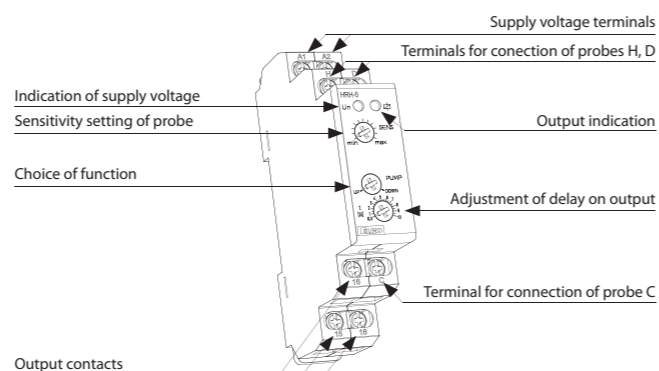

Function

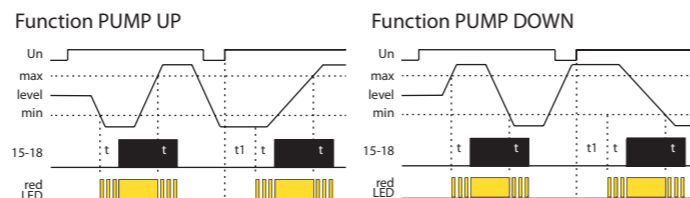

Relay is designated for monitoring of levels of conductive liquids with possibility of functions: PUMP UP or PUMP DOWN. To prevent polarization and liquid electrolysis of liquid, and undesirable oxidation of measuring probes, alternating current is used. For measuring use three measuring probes: H- upper level, D- lower level, C - common probe. In case you use a tank made of a conductive material, you can use it as probe C. In case you require monitoring of one level only, it is necessary to connect inputs H and D and connect them to one probe - in this case sensitivity is lowered by half (2.5.. 50 kΩ). Probe C can be connected with a protective wire of supply system (PE). To prevent undesirable switching out output contacts by various influences (sediment on probes, humidity...) it is possible to set sensitivity of the device according to conductivity of monitored liquid (corresponding to "resistance" of liquid) range 5 up to 100 kΩ. To reduce influences of undesirable switching of output contacts by liquid gorgle in tanks, it is possible to set delay of output reaction 0.5 - 10s.

Connection

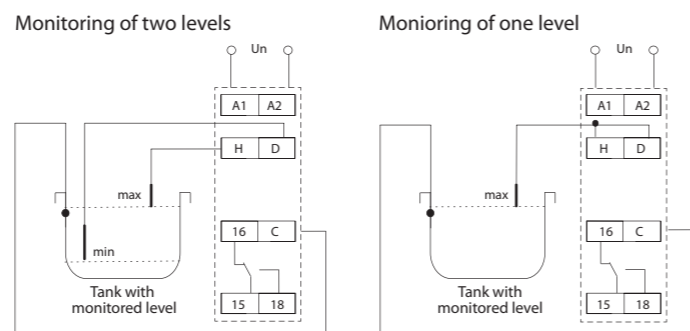

EAN code
HRH-5: 8595188136396

Technical parameters		HRH-5
Functions:		2
Supply terminals:		A1 - A2
Voltage range:		24.. 240 V AC / DC (AC 50 - 60 Hz)
Input:		max. 2 VA / 1.5 W
Max. dissipated power (Un + terminals):		2 W
Tolerance of voltage range:		-15 %; +10 %
Measuring circuit		
Sensitivity (input resistance):		adjustable in range 5 kΩ - 100 kΩ
Voltage n electrodes:		max. AC 3.5 V
Current in probes:		AC < 0.1 mA
Time response:		max. 400 ms
Max. capacity of probe cable:		800 nF (sensitivity 5kΩ), 100 nF (sensitivity 100 kΩ)
Time delay (t):		adjustable, 0.5 -10 sec
Time delay after switching on (t1):		1.5 sec
Accuracy		
Accuracy in setting (mech.):		± 5 %
Output		
Number of contacts:		1x changeover / SPDT (AgNi / Silver Alloy)
Current rating:		8 A / AC1
Switching voltage:		2000 VA / AC1, 240 W / DC
Switched voltage:		250 V AC1 / 24 V DC
Mechanical life (AC1):		1x10 ⁷
Electrical life:		1x10 ⁵
Other information		
Operational temperature:		-20 °C to 55 °C (-4 °F to 131 °F)
Storing temperature:		-30 °C to 70 °C (-22 °F to 158 °F)
Electrical strength:		2.5 kV (supply - sensors)
Operational position:		any
Mounting:		DIN rail EN 60715
Protection degree:		IP40 from front panel / IP10 terminals
Overvoltage category:		II.
Pollution degree:		2
Profile of connecting wires (mm ²):		max. 2x 2.5, max. 1x 4 / with sleeve max. 1x 2.5, max. 2x 1.5 (AWG 12)
Dimensions:		90 x 17.6 x 64 mm (3.5" x 0.7" x 2.5")
Weight:		73 g (2.6 oz.)
Standards:		EN 60255-6, EN 61010-1
Recommended measuring probes:		see pg. 100

Symbol

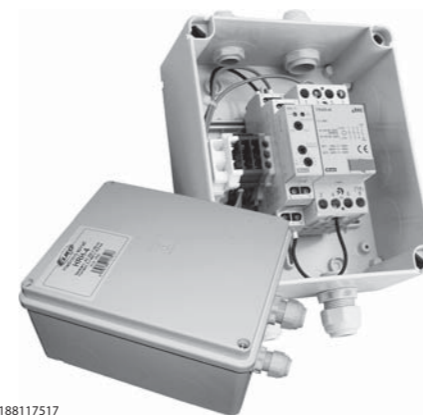
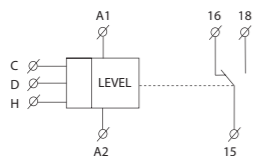

EAN code
HRH-4 /230V: 8595188117517
HRH-4 /24V: 8595188117500

Technical parameters		HRH-4
Function:		2
Voltage range:		AC/DC 230 V or AC/DC 24 V (AC 50 - 60 Hz)
Burden:		max. 7 VA / 1.5 W
Max. dissipated power (Un + terminals):		4 W
Operating range:		-15 %; +10 %
Measuring circuit		
Sensitivity (input resistance):		adjustable in range 5 kΩ - 100 kΩ
Voltage on electrodes:		max. AC 3.5 V
Current on probes:		AC < 0.1 mA
Time response:		max. 400 ms
Max. capacity of probe cable:		800 nF (sensitivity 5 kΩ), 100 nF (sensitivity 100 kΩ)
Time delay (t):		adjustable, 0.5 - 10 sec
Time delay (t1):		1.5 sec
Accuracy		
Setting accuracy (mech.):		± 5 %
Output		
Number of contacts:		4x switching
Rated thermal current:		25 A
Loading in AC3:		4 kW / 400 V
Mechanical life:		3x10 ⁶
Other information		
Operation temperature:		-20 °C to 55 °C (-4 °F to 131 °F)
Storage temperature:		-30 °C to 70 °C (-22 °F to 158 °F)
Electrical strength (supply-output):		3.75 kV, galvanically insulated
Operating position:		any
Protection degree:		IP55
Pollution degree:		2
Dimensions:		160 x 135 x 83 mm (6.3" x 5.3" x 3.3")
Weight:		743 g (26.2 oz.)
Standards:		EN 60255-6, EN 61010-1
Recommended measuring probes:		see pg. 100

Function description

- PUMP UP** - in case the level falls under a lower limit (sensor D), a relay switches and a pump pumps a liquid up until it reaches an upper limit (probe H), then a relay opens and a pump stops pumping. When a level reaches a lower limit again, all process is repeated. After the device is energized, relay automatically closes and a pump pumps liquid to upper limit.
- PUMP DOWN** - in case a level reaches over an upper limit, a relay closes and a pump pumps liquid down. In case a level reaches a lower limit, a relay opens and a pump stops pumping. When energized, a relay is in an open state and a pump operates only after an upper limit is exceeded.
- In case you combine inputs H and D and connect them to one probe, the device will keep only one level (upper and lower limit will become one). In function PUMP UP relay closes in case the level falls under a probe level. A pump pumps liquid up and in case the level reaches a probe level, a relay opens and a pump stops. The level is kept in a small range around the probe. In function PUMP DOWN relays closes in case a level reaches a probe level. A pump pumps down until the level reaches a probe, then relay opens and pump stops.

- In an easy way it automates operations of pumps depending on level.
- Control of level in wells, tanks, reservoirs...
- It is delivered as a connected set - easy installation.
- Possibility to monitor level of any type of conductive liquid.
- It serves for an automatic operation in 1-phased and 3-phased pumps.
- Set of level switch HRH-5 and a contactor VS425.
- Function choice - pumping up or down.
- Unit requires incoming over-current protection.
- Protection degree of the set is IP55.
- There is a possibility of 4 types of probes in a various design (they are not a part of this set, it is possible to deliver).
- Unit is placed in a plastic box with dimensions 160x135x 83 mm (6.3x 5.3x 3.3").

Function

Function PUMP UP

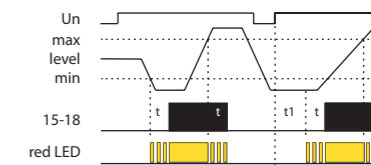

Function PUMP DOWN

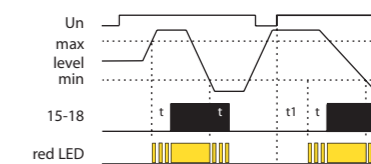

Connection

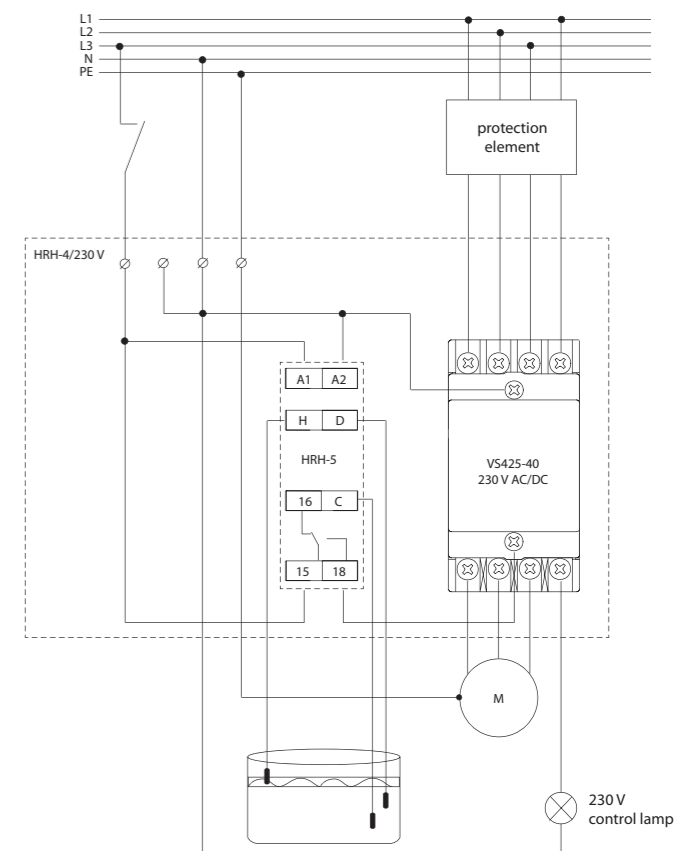



EAN code
HRH-6 /AC: 8595188136990
HRH-6 /DC: 8595188137409
HRH-6S: 8595188137416

Technical parameters	HRH-6/DC	HRH-6/AC
Function:	2	
Voltage range:	12.. 24 V DC	230 V AC / 50 - 60 Hz
Burden:	max. 1.8 W	max. 3.8 VA
Max. dissipated power (Un + terminals):	3 W	
Supply tolerance:	± 20%	-20 %; +10 %
Measuring circuit		
Sensitivity adjustable in the range*:	min. 10 kΩ	max. 200 kΩ
Voltage on probes:	max. 3 V AC	
Probe cable maximum capacity:	500 nF (for min. sensitivity), 50 nF (for maximum sensitivity)	
Time delay:	adjustable 1.. 10 s	
Output		
Number of contacts:	6x LED (1x red, 1x yellow, 4x green)	
Current rating:	10 A / AC1	
Switching voltage:	2500 VA / AC1, 200 W / DC	
Peak current:	16 A / < 3 s	
Switching voltage:	250 V AC1 / 24 V DC	
Mechanical life (AC1):	3x10 ⁷	
Electrical life:	0.7x10 ⁵	
Other information		
Operating temperature:	-20 °C to 55 °C (-4 °F to 131 °F)	
Storage temperature:	-30 °C to 70 °C (-22 °F to 158 °F)	
El. strength (supply - probes):	x	3.75 kV
Operating position:	any	
Protection degree:	IP65	
Overvoltage category:	x	III.
Pollution degree:	2	
Dimensions:	110 x 130 x 72 mm (4.3" x 5.1" x 2.8")	
Weight:	288 g (10.2 oz.)	385 g (13.6 oz.)
Standards:	EN 60255-6, EN 61010-1	
Recommended measuring probe:	see pg. 100	

* Note: sensitivity is higher at both ends of a range of values.

Connection

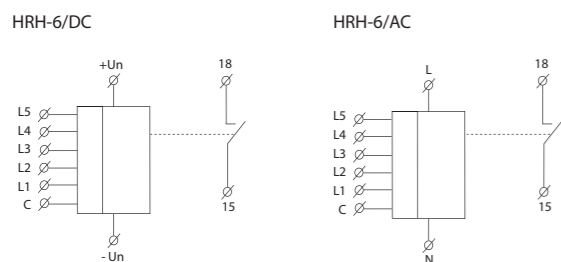

- Function 1 monitors minimal and maximal level depth, for example in fire engine cars, tanks etc.
- Function 2 monitors level depth in water collectors, basins, pools etc.
- Selection of particular function is made by jumper on the front panel.
- Level depth is indicated on the panel of device by LED.
- Device monitors 5 levels by using six probes (one probe is common).
- Common probe can be replaced by a metal (conductive) tank.
- Level indication by six LED's on the front panel of the device.
- It is possible to connect another indication module (e.g. in fire-engine cabin).
- Adjustable sensitivity according to liquid conductivity.
- Adjustable time delay - elimination of level movement, e.g. while a tank is being filled up.
- Measuring frequency 10 Hz to prevent polarization of liquid.
- Supply voltage 12.. 24 V DC (to be used in fire-engines) or galvanically separated 230 V AC for general use.
- Contact relay 10 A for signalization of full / empty tank (according to a chosen function).
- Choice of functions PUMP UP / OFF / PUMP DOWN by a switch located on the front panel of the device.
- Protection degree IP65.

Description

HRH-6/DC Basic unit

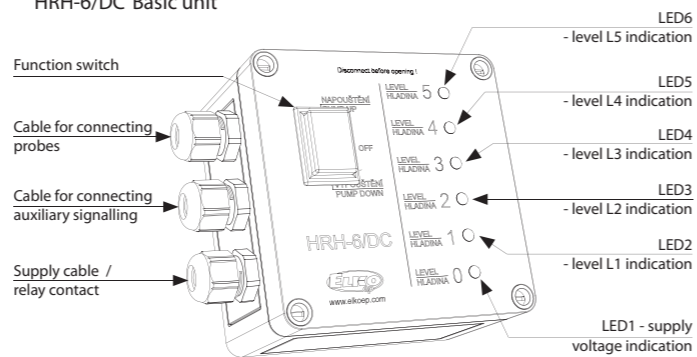

HRH-6/S Auxiliary signalling

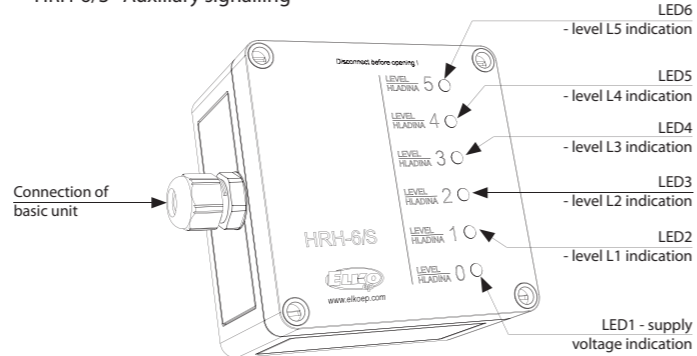

Setup elements (inside basic unit)

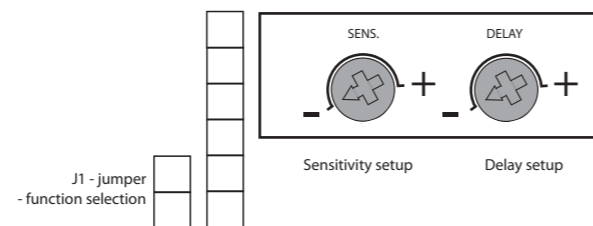

HRH-6 block connecting

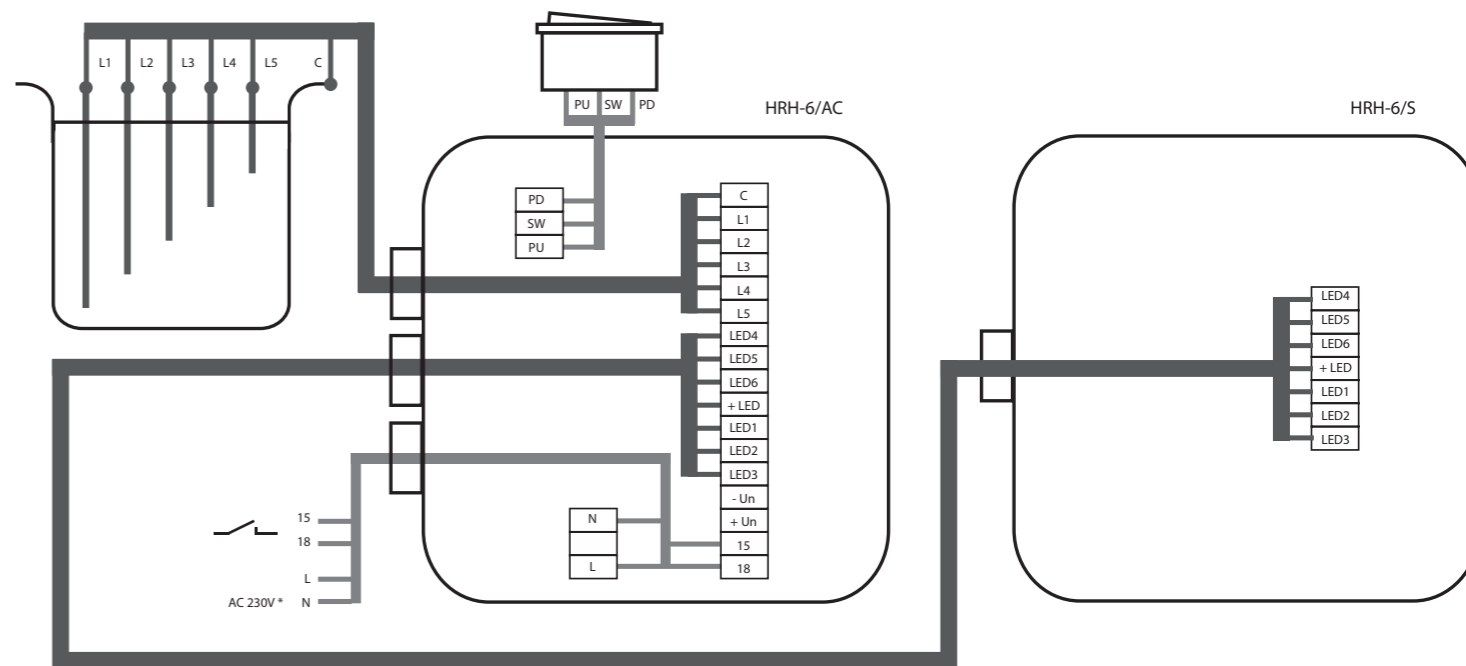

* In case of HRH-6/DC, incoming supply is connected on terminals +Un and - Un.

Functions

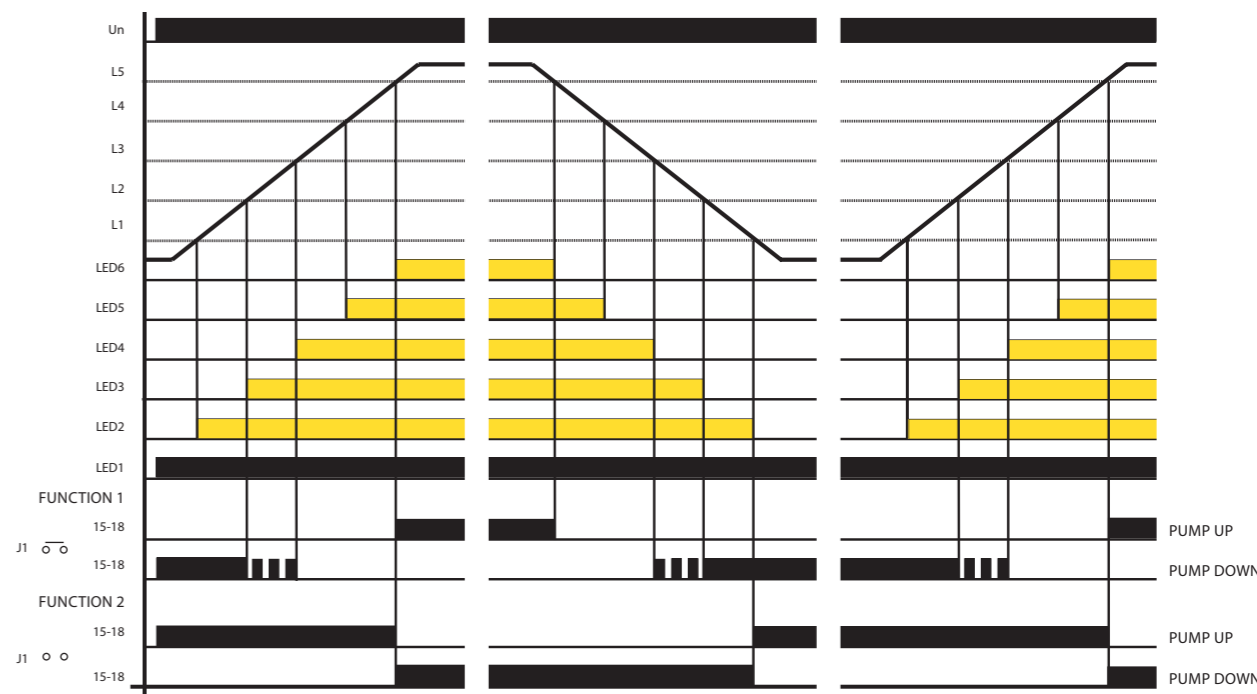

This device monitors level of a conductive liquid in a tank by using six single probes or one 6-fold probe. In case you use a tank made of a conductive material, it is possible to use it as a common probe C.

This common probe is connected to a pole of supply (for fire-engines it means its body) in case of supply voltage 12.. 24 V DC.

In case of supply voltage 230 V AC, the circuits are galvanically separated from the main.

The device is controlled by a three-position switch PUMP UP / OFF / PUMP DOWN. After switching into a position PUMP UP or PUMP DOWN, red LED1 shines and then also LED2.. LED6 according to liquid level. Output relay has 2 selectable functions.

Function setting is done by a jumper on basic board of HRH-6.

Function 1: (for use in fire-engines) - jumper is applied. In case of function PUMP UP and level reaching L5, the relay controlling e.g. acoustic signalization, permanently closes and indicates full tank. In case of PUMP DOWN function and level drop under level L3, relay periodically switches and under L2 it switches permanently (indicates almost empty tank).

Function 2: (for keeping liquid level) - jumper is not applied. In case of PUMP UP, sensor is switched until liquid reaches level L5. Then relay opens and switches again in case the liquid level falls under level L1. In case of PUMP DOWN - relay is switched until liquid falls under level L1. Then relay opens and switches again on level L5.

To eliminate LED flashing while level gurgles it is possible to delay reaction of probes (set delay 1.. 10s). According to conductivity of liquid it is possible to set sensitivity of probes (corresponding to "resistance" of liquid).



EAN code
HRH-7: 8595188149471

Technical parameters	HRH-7
Function:	2
Supply terminals:	A1 - A2
Supply voltage:	24.. 240 V AC / DC (AC 50 - 60 Hz)
Burden:	max. 2 VA / 1.5 W
Max. dissipated power (Un + terminals):	3 W
Supply voltage tolerance:	-15 %; +10 %
Max. value of overcharge protection:	16 A
Measuring circuit	
Sensitivity (input resistance):	adjustable from 5 kΩ - 100 kΩ
Voltage on electrodes:	max. AC 3.5 V
Current on probes:	AC < 0.1 mA
Time response:	max. 400 ms
Max. capacity of probe cable:	800 nF (sensitivity 5kΩ), 100 nF (sensitivity 100 kΩ)
Time delay (t):	adjustable, 0.5 -10 sec
Time delay (t1):	1.5 sec
Accuracy	
Setting accuracy (mechanical):	± 5 %
Output	
Number of contacts:	1x changeover / DPDT (AgSnO ₂)
Current rating:	16 A / AC1
- contact NO:	15-18: 6A / AC3
- contact NC:	15-16: 3A / AC3
Switching capacity:	4000 VA / AC1, 384 W /DC
Switching voltage:	250 V AC / 24 V DC
Mechanical life:	3x10 ⁷
Electrical life (AC1):	0.7x10 ⁵
Other information	
Operating temperature:	-20 °C to 55 °C (-4 °F to 131 °F)
Storage temperature:	-30 °C to 70 °C (-22 °F to 158 °F)
Electrical strength:	3.75 kV (supply - sensor)
Operating position:	any
Protection:	IP65
Overvoltage category:	III.
Contamination degree:	2
Cable size (mm ²):	max. 2x 2.5 / with sleeve max. 2x 1.5 (AWG 12)
Dimension:	139 x 139 x 56 mm (5.5 x 5.5 x 2.2")
Weight:	241 g (8.5 oz.)
Related standards:	EN 60255-6, EN 61010-1
Recommended measuring probes:	see pg. 100

Symbol

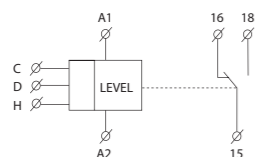

- Suitable to operate / work in harsh conditions due to the high degree of protection IP65
- Switch monitors the level changes in wells, reservoirs, tanks, tankers etc.
- It is possible to select the following configurations:
 - one-level switch of conductive liquids monitors one level (by connecting H and D)
 - two-level switch of conductive liquids monitors two levels (switches on at one level and switched off at another level)
- Choice of function PUMP-UP or PUMP-DOWN
- Adjustable time delay of output (0.5 - 10 s)
- Adjustable sensitivity using potentiometer (5 - 100 kΩ)
- Measuring frequency 10 Hz prevents liquid polarization and increased oxidation of measuring probes
- Measuring circuits are galvanically separated from the power source of the product and circuits of the relay contact by enhanced insulation according to EN 60664-1 for overvoltage category III.
- Output contact: 1x changeover / DPDT 16 A / 250 V AC1

Device description

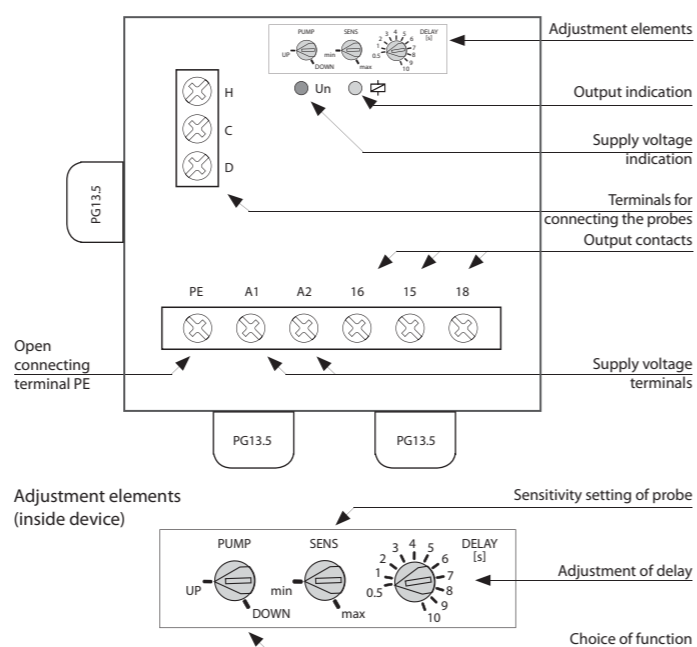

Connection

connection for power supply 230 V AC

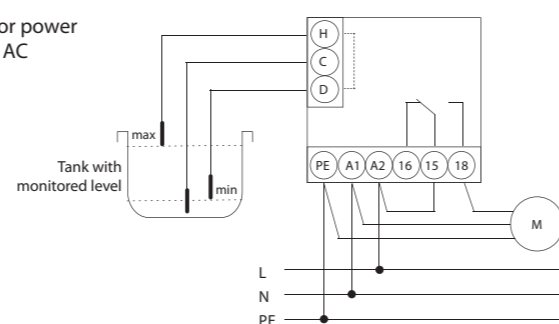

connection for power supply 24.. 240 V AC/DC

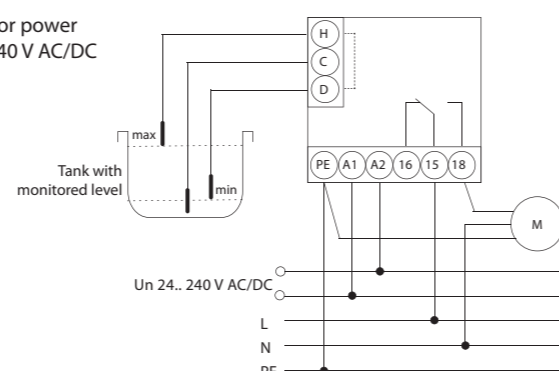

Function

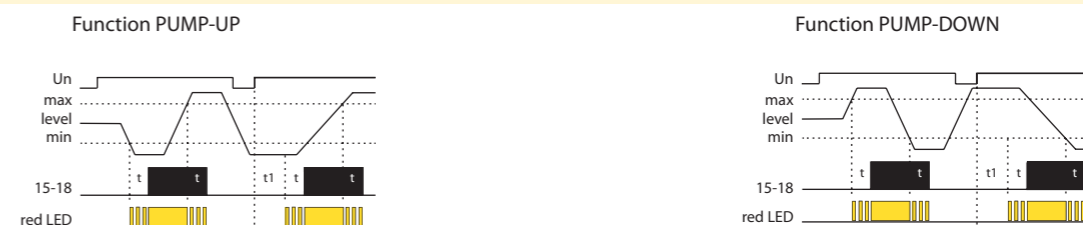

An AC current is used for measuring to prevent polarization and electrolysis of fluid and unwanted oxidation of measuring probes. Three probes are used for measuring: H - upper level, D - lower level and C - common probe. If using a tank made from conductive material, it is possible to use the tank itself as probe C.

If it is necessary to monitor only one level, there are two connection options:

1. Inputs H and D are connected to a single probe - in this case the sensitivity is decreased to half (2.5.. 50 kΩ).
2. Inputs H and C are connected and the probe is connected to input D - in this case, the original sensitivity remains (5..100 kΩ).

It is also possible to connect probe C with a protective conductor of the power system (PE).

Example of connecting the level switch to a 1-phase pump at a well, borehole

wiring for supply 230 V AC (for monitoring two levels)

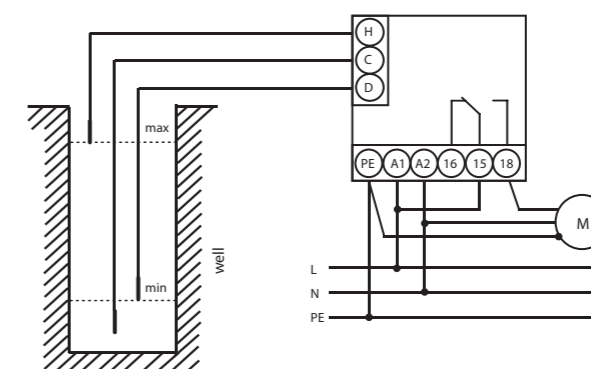

Monitoring TWO LEVELS of the FLUID LEVEL minimum / maximum - DRAINING function - (PUMP DOWN)

Description of draining function:

This function is used in a well or borehole where the difference between the upper and lower probes determines how much water the pump can pump out and protect against running dry.

After detecting the maximum level, the set reaction delay begins running. After this period, the output contact immediately switches on the pump until the minimum level is reached, when the set delay begins running once again. The pump then switches off.

Monitoring TWO LEVELS minimum / maximum - REPLENISHING function - (PUMP UP)

Description of replenishing function:

This function is used when you need to regularly pump in water to a well or borehole, which is leaking.

After detecting the minimum level, the set reaction delay begins running. After this period, the output contact immediately switches on the pump for the period until it reaches the maximum level, where the set delay begins running once again. The pump then switches off.

Example of connecting the level switch to a 3-phase pump at the well, borehole

wiring for supply 230 V AC (for monitoring two levels)

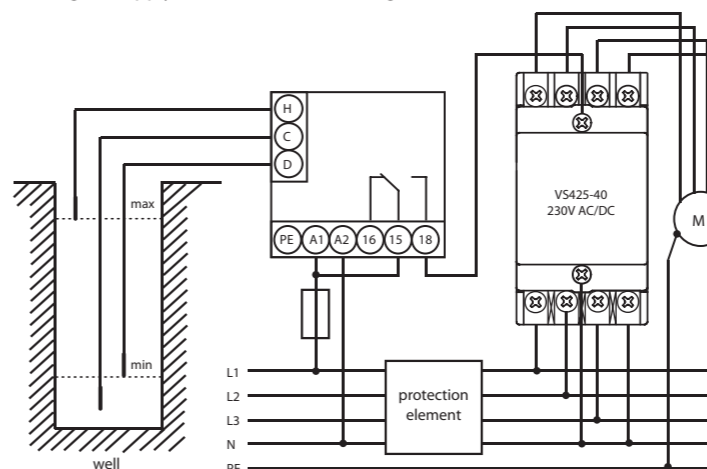

Monitoring TWO LEVELS minimum / maximum - DRAINING function - (PUMP DOWN)

Description of draining function:

The function is used to protect against overflows and flooding of areas. After detecting the maximum level, the set reaction delay begins running. After this period, the output contact immediately switches on the 3-phase pump until the minimum level is reached, when the set delay begins running once again. The pump then switches off.

INNOVATION



EAN code
 HRH-8/110V: 8595188156387
 HRH-8/230V: 8595188155427
 HRH-8/24V: 8595188155564
 HRH-8/400V: 8595188171199

Technical parameters		HRH-8
Function:	8	
Supply terminals:	A1 - A2	
Voltage range:	AC 110 V, AC 230 V, AC 400 V or AC/DC 24 V galvanically separated (AC 50-60Hz)	
Burden max.:	2.5 W / 5 VA (AC 230 V, AC 110 V, AC 400 V), 1.4 W / 2 VA (AC/DC 24 V)	
Max. dissipated power (Un + terminals):	4 W (110 V, 230 V, 400 V); 3 W (24 V)	
Supply voltage tolerance:	-15 %; +10 %	
Measuring circuit		
Hysteresis (input - opening):	in an adjustable range 5 kΩ - 100 kΩ	
Voltage on electrode:	max. AC 3.5 V	
Current in probes:	AC < 1 mA	
Time reaction:	max. 400 ms	
Max. cable capacity:	800 nF (sensitivity 5kΩ), 100 nF (sensitivity 100 kΩ)	
Time delay t:	adjustable 0.5 - 10 sec	
Accuracy		
Setting accuracy (mech.):	± 5 %	
Output		
Number of contacts:	2x changeover / SPDT (AgNi / Silver Alloy)	
Current rating:	16 A / AC1	
Breaking capacity:	4000 VA / AC1, 384 W / DC	
Inrush current:	30 A / < 3 s	
Switching voltage:	250 V AC1 / 24 V DC	
Output indication:	red LED	
Mechanical life:	3x10 ⁷	
Electrical life (AC1):	0.7x10 ⁶	
Other information		
Operating temperature:	-20 °C to 55 °C (-4 °F to 131 °F)	
Storage temperature:	-30 °C to 70 °C (-22 °F to 158 °F)	
Electrical strength:	4 kV (supply - output)	
Operating position:	any	
Mounting:	DIN rail EN 60715	
Protection degree:	IP40 from front panel / IP20 terminals	
Overvoltage category:	III.	
Pollution degree:	2	
Max. cable size (mm ²):	solid wire max. 1x 2.5 or 2x1.5 /with cavern max. 1x 1.5 (AWG 12)	
Dimensions:	90 x 52 x 65 mm (3.5" x 2" x 2.6")	
Weight:	247 g / 8.7 oz (110 V, 230 V, 400 V); 145 g / 5.1 oz (24 V)	
Standards:	EN 60255-6, EN 61010-1	
Measuring sensors:	see pg. 100	

Symbol

HRH-8 (110V, 230V, 400V)

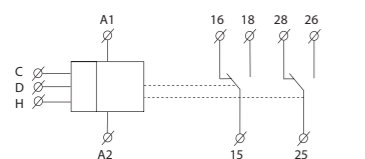

HRH-8/24V

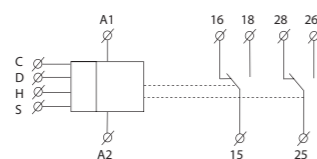

- Relay is designed to control the level of conductive liquids in wells, tanks, pools, tankers, reservoirs... (replacement HRH-1)
- Galvanically isolated supply and guard circuits
- Within one device, the following configurations can be selected:
 - 2x one-level monitoring (in separate tanks)
 - 1x two-level monitoring (in one tank)
 - Pumping from one tank to another
- DIP switch selection on the front panel (8 functions)
- Adjustable probe sensitivity (for each probe separately)
- Adjustable relay switching delay (for each probe separately)
- 10Hz watch frequency prevents polarization of the liquid and increases resistance to interference by network frequency
- 2x output relay (with changeover contact 16A / 250V AC1)
- 3-MODULE design, mounting onto DIN rail.

Description

HRH-8/24V

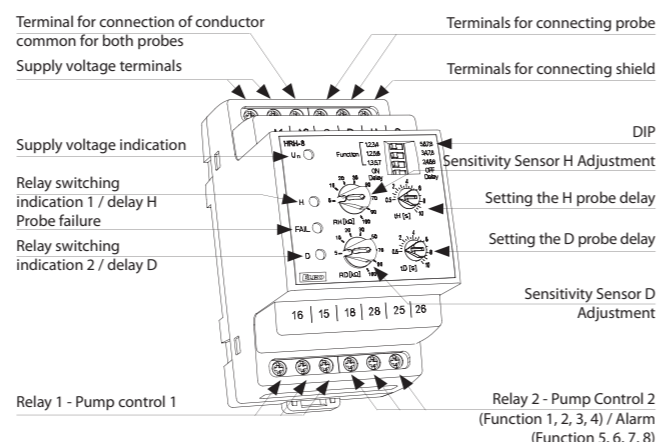

Description and importance of DIP switches

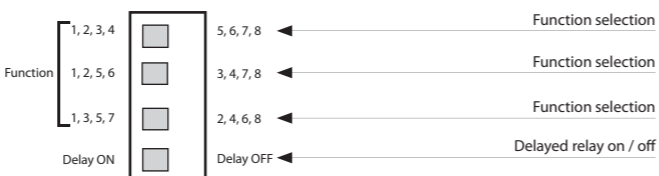

Connection

HRH-8 (110V, 230V, 400V)

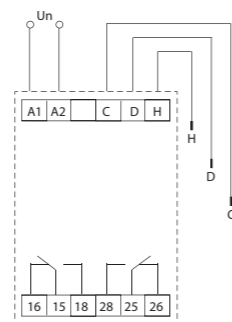

HRH-8/24V

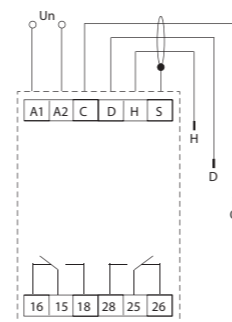

Measuring probes

There can be any measuring probe (any conductive contact, it is recommended to use brass or stainless steel).
 The probe wire does not need to be shielded, but it is recommended.
 When using a shielded wire, the shielding is connected to terminal S.

Functions

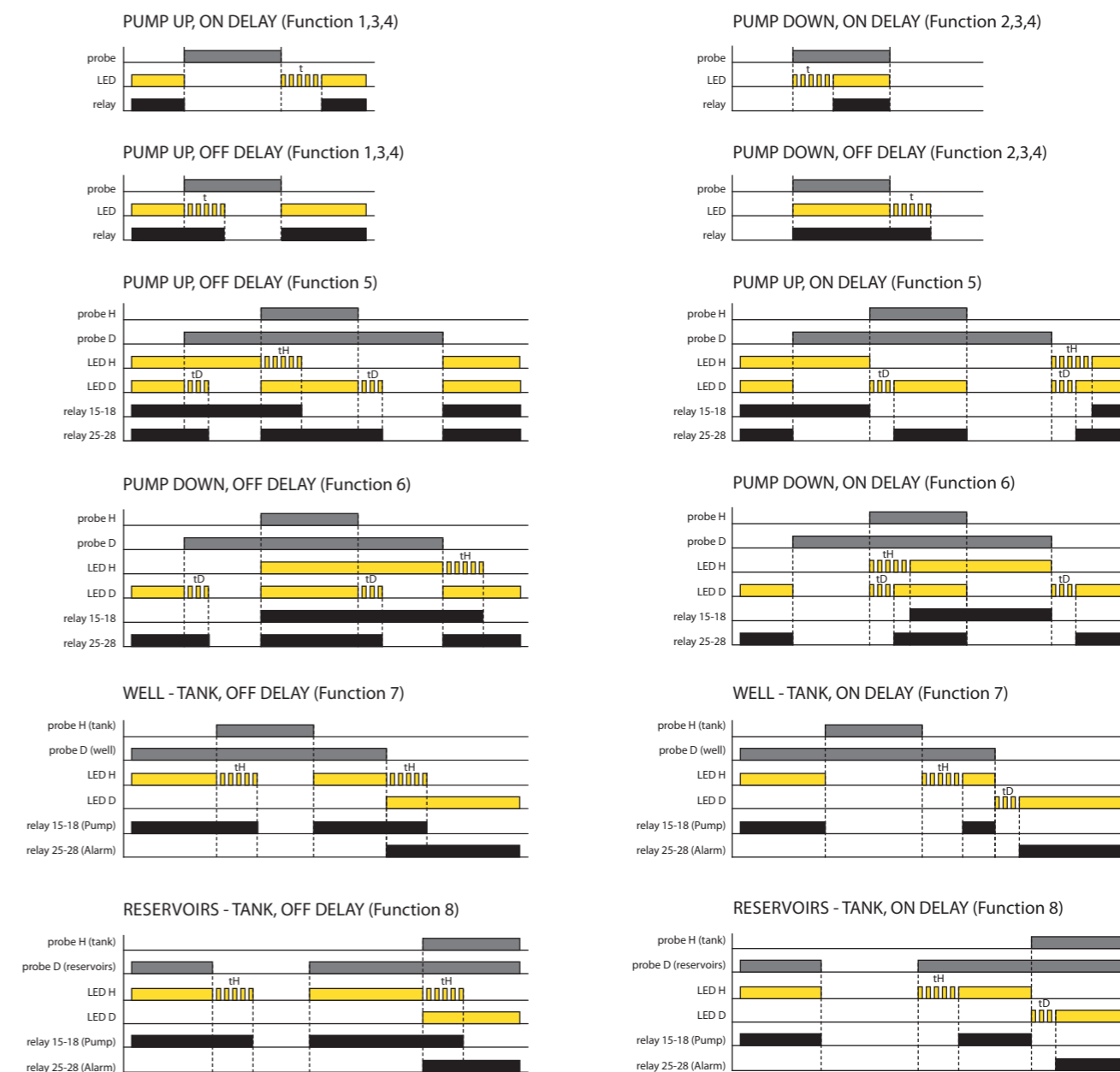

The relay is designed to monitor the level of conductive liquids with a choice of 8 functions:

- 2 separate tanks (each with 1 probe) - both PUMP UP (filling)
- 2 separate tanks (each with 1 probe) - both PUMP DOWN (emptying)
- 2 separate tanks (each with 1 probe) - H PUMP DOWN probe, D PUMP UP probe
- 2 separate tanks (each with 1 probe) - H PUMP UP probe, probe D PUMP DOWN
- both probes in one tank - PUMP UP - maintain level between probes H and D (as HRH-5), relay 1 switches on the pump, relay 2 alarm (level is not between probes H and D)
- Both probes in one tank - PUMP DOWN - maintaining the level between probes H and D (as HRH-5), relay 1 switches on the pump, relay 2 alarm (the level is not between probes H and D)
- Pumping from the well to the tank - probe D in the well, probe H in the tank. The pump only runs if the probe D is flooded (enough water in the well) and the tank is not full (probe H). The alarm reports a lack of water in the well (probe D is not flooded).
- Pumping from the sump to the tank - probe D in the sump, probe H in the tank. The pump only runs if the probe D is flooded (full tank) and the tank is not full (probe H). The alarm reports the status of full tank and sump (both probes are flooded).

LED indication:

The red LED lights up - the corresponding relay is switched on
 Red LED flashes - delay timing

The yellow LED indicates probe failure - Functions 5, 6 probe H is flooded and probe D is not. At the same time both red LEDs flash.

To prevent polarization and electrolysis of the liquid and undesirable oxidation of the monitoring probes, an AC current of 10 Hz is used for monitoring. The low frequency has a positive effect on suppression of interference by 50 (60) Hz. Three probes are used to monitor the level: H - upper level, D - lower level and C - common probe. In the case of the use of a conductivity material tank, it is possible to use the tank itself as a C probe. Probe C can also be connected to the protective conductor of the power supply system (PE). To prevent undesired switching by various influences (soiling of dips, moisture ...), the sensitivity of the device can be set according to the conductivity of the liquid being monitored (corresponding to the "resistance" of the liquid) in the range of 5 to 100 kΩ. To limit the effect of undesired switching of output contacts by raising the liquid level in the tank, it is possible to set the output response delay 0.5 - 10 s.



- Level sets are used to monitor levels in wells, reservoirs, tanks...
- Advantage is the possibility of setting PUMP UP and PUMP DOWN and also delayed switching (e.g. in case of level fluctuations).
- The possibility of connection to 1 or 3-phase pump (depending on the type of set).
- Easy to install without complicated wiring - ready for installation.
- There are Level sets placed in switchboard with IP65 protection (protected against dust and against water jets)
 - HRH-VS: level switch HRH-5 with installation contactor VS425-40 (25A contact)
 - HRH-MS-1A: level switch HRH-5 with motor starter MS18 0.63-1A
 - HRH-MS-1.6A: level switch HRH-5 with motor starter MS18 1-1.6A
 - HRH-MS-VS-2.5A: level switch HRH-5 with installation contactor VS425-40 (25A contact) and with motor starter MS18 1.6-2.5 A
 - HRH-MS-VS-4A: level switch HRH-5 with installation contactor VS425-40 (25A contact) and with motor starter MS18 2.5-4 A
 - HRH-MS-VS-6.3A: level switch HRH-5 with installation contactor VS425-40 (25A contact) and with motor starter MS18 4-6.3 A

EAN code
 HRH-VS: 8595188150699
 HRH-MS-1A: 8595188150873
 HRH-MS-1.6A: 8595188150705
 HRH-MS-VS-2.5A: 8595188150880
 HRH-MS-VS-4A: 8595188150712
 HRH-MS-VS-6.3A: 8595188150835

Technical parameters	HRH-VS	HRH-MS-1A	HRH-MS-1.6A	HRH-MS-VS-2.5A	HRH-MS-VS-4A	HRH-MS-VS-6.3A
Function:	2					
Voltage range:	230 / 400 V AC 50 - 60 Hz					
Input (max.):	4.6 VA / 1.5 W	2 VA / 1.5 W	2 VA / 1.5 W	4.6 VA / 2 W	4.6 VA / 2 W	4.6 VA / 2 W
Tolerance of voltage range:	-15 %; +10 %					
Measuring circuit						
Sensitivity (input impedance):	adjustable in range 5 kΩ - 100 kΩ					
Voltage on the electrodes:	max. AC 3.5 V					
Current in probes:	AC < 0.1 mA					
Time response:	max. 400 ms					
Max. capacity of probe cable:	800 nF (sensitivity 5 kΩ), 100 nF (sensitivity 100 kΩ)					
Time delay (t):	adjustable, 0.5 - 10 sec					
Time delay after switching on (t1):	1.5 sec					
Accuracy:						
Setting accuracy (mech.):	± 5 %					
Output						
Number of contacts:	4	1	1	4	4	4
Rated thermal current:	25 A	8 A	8 A	25 A	25 A	25 A
Load on AC3:	4 kW	1 A	1.6 A	2.5 A	4 A	6.3 A
Switching voltage:	230 V / 400 V	230 V	230 V	400 V AC	400 V AC	400 V AC
Electric life (A3):	0.5 x 10 ⁶	1 x 10 ⁵	0.5 x 10 ⁶	0.5 x 10 ⁶	0.5 x 10 ⁶	0.5 x 10 ⁶
Current setting range MS18:	-	0.63 - 1 A	1 - 1.6 A	1.6 - 2.5 A	2.5 - 4 A	4 - 6.3 A
Other information						
Operating temperature:	-20 °C to 55 °C (-4 °F to 131 °F)					
Storage temperature:	-25 °C to 70 °C (-13 °F to 158 °F)					
Electrical strength:	3.75 kV (supply - probe)					
Operating position:	any					
Protection degree:	IP65 set					
Pollution degree:	2					
Dimension:	201 x 128 x 120 mm (7.9 x 5 x 4.7")			201 x 202 x 120 mm (7.9 x 7.9 x 4.7")		
Weight:	862 g (30.4 oz.)	872 g (30.7oz.)	872 g (30.7oz.)	1358 g (47.9 oz.)	1358 g (47.9 oz.)	1358 g (47.9 oz.)
Related standards:	EN 60255-6, EN 61010-1					
Recommended measuring probes:	see pg. 100					

Functions

PUMP DOWN function (DOWN) used for protection against Idle Running or against overflow and flooding areas.

Detecting the maximum level results in activation of adjusted delayed response. After that output contact immediately turns on single or 3-phase pump until it reaches the minimum level. Then the pump turns off.

In case that a reservoir is made of a conductive material e.g. metal tanks, there can be a difference in connection of HRH-5 level sets - it is not necessary to put inside a common probe „C“ and connect with SHR-2 probe, but thanks to conductivity of vessel we can connect probe C to the reservoir body.

The length of wire cable (between the level switch and probe) can be up to 50 m. We don't recommend placing near the power lines, because the sensitivity of equipment can be affected and thus the entire functionality.

Recommended accessories:

- 3 wire cable D03VV-F 3x0,75/3,2

- 1 wire cable D05V-K 0,75/3,2

- SHR-2 probe - probe covered by PVC (protected) - used in moderately polluted waters, drilling, wells. Assembly - hanging in the well.

Connection

Level set HRH-VS

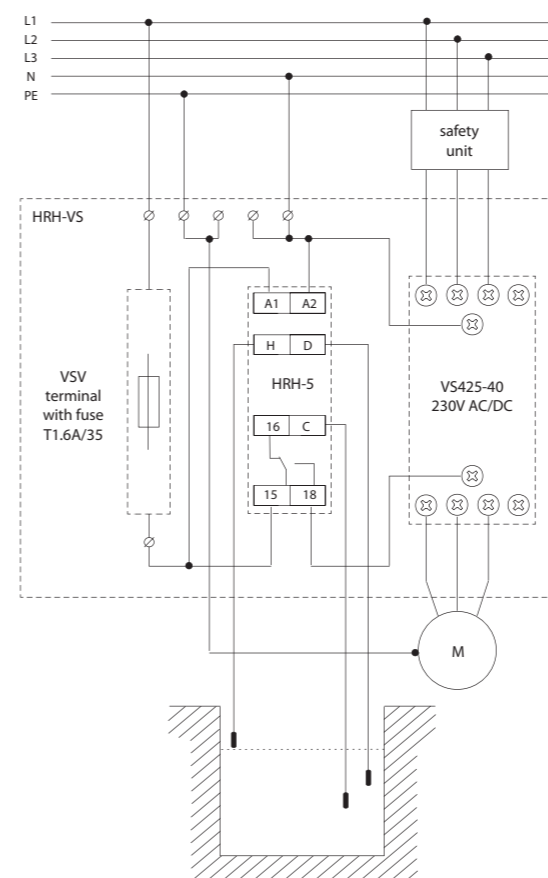

Level set HRH-MS-1A (HRH-MS-1.6A)

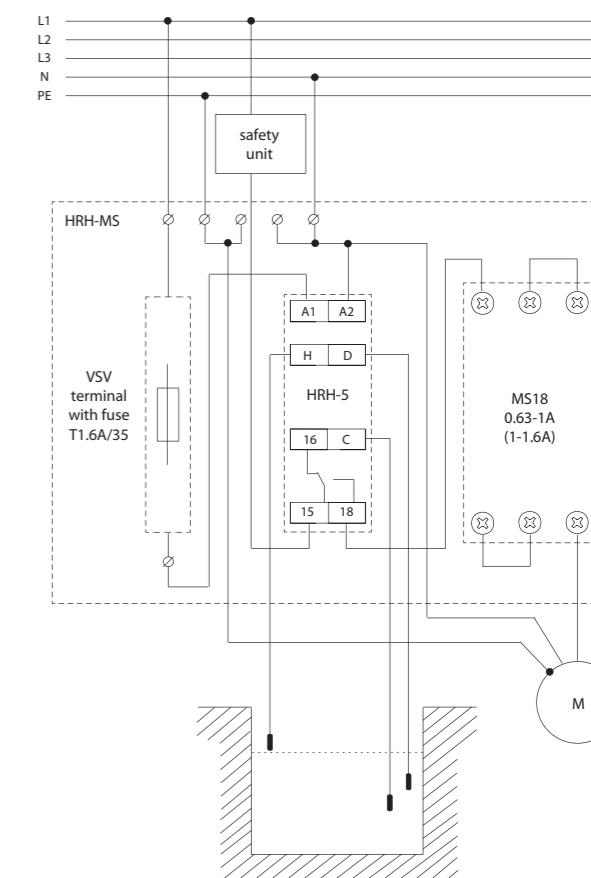

Level set HRH-MS-VS-2.5A (HRH-MS-VS-4A, HRH-MS-VS-6.3A)

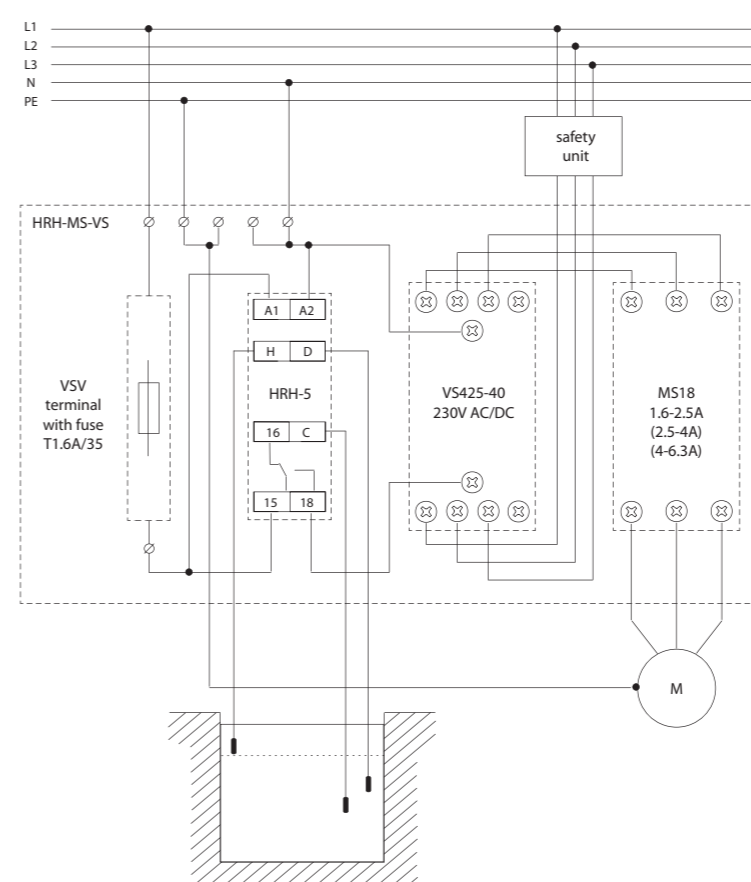

SHR-1-M, SHR-1-N, SHR-2, SHR-3 | Level sensors



EAN code
SHR-1-M: 8595188110105
SHR-1-N: 8595188111379

SHR-1-M: brass sensor**SHR-1-N:** stainless steel sensor

- Sensor to control flooding.
- Suitable for use in drinking water.
- Electrode with diameter 4 mm (0.2") is placed in plastic cover.
- Panel or to holder mounting.
- Conductor is connected to terminal board, shrink bushing for feeder place insulation is a part of device.
- Max. wire profile: 2.5 mm² (AWG10).
- Installation: after connecting a wire to the sensor, run the shrink bushing over the wire onto the sensor.
- Heat the sensor and by shrinking the connection of sensor and wire will be hermetical.
- Weight: 9.7 g (0.3 oz.).
- Operating temperature: -25 °C to +60 °C (-13 °F to 140 °F).
- Total sensor length: 65.5mm (2.58").

Level probe SHR-2

- Detection sensor is electrode, which in connection with switchable device is used for level detection for example in wells, tanks,...
- To be used in electric conductive fluids and mechanically polluted fluids with temperature: 1°C to 80°C (33.8 °F to 176°F).
- Suitable for use in drinking water.
- Stainless steel one-pole electrode reside in PVC cover, intended for tank wall mounting or mounting by socket.
- To ensure correct function of the sensor, it is necessary to have the electrode without dirt which could disable the connection of the electrode and fluid and thus lead to malfunction.
- Max. wire profile: 2.5 mm² (AWG 10).
- Recommended wire D05V-K0.75/3.2.
- Installation:
 - conductor wire is connected by feazing of two brass screws to stainless steel electrode.
 - conductor is caulked by bushing Pg7 with protection degree IP68.
- Weight: 48.6 g (1.7 oz.)
- Dimensions: max. diameter 21 mm (0.8"), length 96 mm (3.8").

SHR-2 in open state



Level probe SHR-3

- Stainless probe to be used into demanding industrial environments, designated for screwing into tank wall or cover.
- Suitable for use in drinking water
- The probe is installed in horizontal, vertical or in sidelong position on tank side or in tank cover. Installation is done by soldering or by fixing nut. It is necessary to use 24 mm (1") screw. It is necessary to use an adequate torque with regards to a seal and operational over-pressure in a tank.
- Sensor has connecting wire - length 3 m, which is connected to sensor to scan electrode and sensor bushing connecting wire is double-wire PVC AWG 18 (0.75 mm²), connection of wires: brown - scan electrode, blue - sensor bushing.
- Connection M18x1.5 screw.
- Protection degree IP 67.
- Sensor weight without cable: 100 g (3.3 oz.).
- Operating surroundings: place without the danger of detonation, temperature on screw: max. 95°C (203°F).
- Pressure immunity: on 25 °C (77 °F) 4 MPa, on 95 °C (203 °F) 1.5 MPa.
- Weight: 239 g (8.4 oz.).
- Material: bushing and scan electrode: stainless steel W.Nr. 1.4301, insulation insert of electrode: PTFE.
- Internal material: self-extinguishing epoxide resin.
- Operating temperature: -25 °C to 60 °C (-13 °F to 140 °F).
- Total sensor length: 65.5mm (2.58").



EAN code
SHR-3: 8595188111270

D03VV-F | Three-core cable



EAN code
D03VV-F 3x0.75/3.2: 8595188165884

Technical parameters	D03VV-F 3x0.75/3.2
Rated voltage:	300 / 300 V
Test voltage:	2 kV
Capacity:	max. 12.3 nF / 100 m (328')
Core diameter with insulation:	3.2 mm (0.12")
Overall diameter of cable:	8.1 mm (0.31")
Section:	0.75 mm ² (AWG 18)
Length:	1 m (39.37")

- Cable to probes SHR-1 and SHR-2, 3x 0.75 mm² (AWG 18) with a certification for drinking water, 1m (39.37").
- Construction:
 - bright copper stranded core of hole
 - core insulation of special PVC
 - sheath of special PVC.
- Technical specifications and usage:
 - the product meets requirements for direct and permanent contact with drinking water according to § 5 of the Act. 258/2000 Decree of the Ministry of Health. 409/2005 Sb., On hygienic requirements for products coming into direct contact with drinking water and water treatment
 - usable up to 70 °C (158 °F)
 - suitable for submersible conductivity probes for the boreholes, wells and tanks
 - suitable for probes used for level detection of conductive liquids.
 - cable capacity is max. 12.3 nF / 100 m (328')

Cross-section

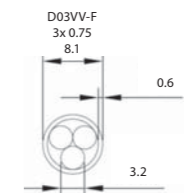

D05V-K | Power cable



EAN code
D05V-K 0.75/3.2: 8595188165945

Technical parameters	D05V-K 0.75/3.2
Rated voltage:	300 / 500 V
Test voltage:	2 kV
Capacity:	max. 12.3 nF / 100 m (328')
Core diameter with insulation:	3.2 mm (0.12")
Section:	0.75 mm ² (AWG 18)
Length:	1 m (39.37")

- Cable to probes SHR-1 and SHR-2, 3x 0.75 mm² (AWG 18) with a certification for drinking water, 1m (39.37").
- Construction:
 - bright copper stranded core of hole
 - insulation of special PVC.
- Technical specifications and usage:
 - the product meets requirements for direct and permanent contact with drinking water according to § 5 of the Act. 258/2000 Decree of the Ministry of Health. 409/2005 Sb., On hygienic requirements for products coming into direct contact with drinking water and water treatment
 - usable up to 70 °C (158 °F)
 - suitable for probes used for level detection of conductive liquids.

Analog

TER

TER-3A -30 to 10 °C (-22 °F to 50 °F) external NTC.

TER-3B 0 °C to 40 °C (32 °F to 104 °F) external NTC.

TER-3C 30 °C to 70 °C (86 °F to 158 °F) external NTC.

TER-3D 0 °C to 60 °C (32 °F to 140 °F) external NTC.

TER-3E 0 °C to 60 °C (32 °F to 140 °F) external NTC.

TER-3F 0 °C to 60 °C (32 °F to 140 °F) in-built NTC.

TER-3G 0 °C to 60 °C (32 °F to 140 °F) external Pt100.

TER-3H -15 °C to 45 °C (5 °F to 113 °F) external NTC.

TER-4 Wide and accurate range of setting -40 °C to 110 °C (-40 °F to 230 °F) in ten ranges in one device, fine temperature setting, 2 inputs for NTC sensor, 2 outputs 16 A changeover/ SPDT, additional function (memory, hysteresis, indication of faulty sensor). Supply: AC 230 V or AC/DC 24 V (galv. separated).

TER-7 Monitoring heating of motor winding in range given by resistance of in-built PTC thermistor (1.8-3.3 kΩ), additional function (memory, reset), output contact 2x 8A changeover/ DPDT, supply: AC/ DC 24-240 V.

Thermo

ATR Analog room thermostat with temperature range 5 to 40 °C (41 °F to 104 °F) night decline, flush mounted in to wiring box.

ATF Analog floor thermostat with temperature range 5 to 50 °C (41 °F to 122 °F) „temporary temperature change “ in range ±10 °C / 50 °F.

ATC Combined thermostat with room and floor sensor, temperature range 5 to 50 °C (41 °F to 122 °F).

TEV

TEV-1 Thermostat with „dead zone“, independent adjustable range -20 to 20 °C (-4 °F to 68 °F), protection against freezing, water-proof type IP65.

TEV-2 Thermostat for regulation of heating (cooling), adjustable range -20 to 20 °C (-4 °F to 68 °F), external sensor NTC, output contact 16A changeover/SPDT.

TEV-3 Thermostat for regulation of heating (cooling), adjustable range 5 to 35 °C (41 °F to 149 °F), external sensor NTC, output contact 16 A, control potentiometer and indication on panel.

TEV-4 Single exterior thermostat for monitoring and regulation of temperature in demanding environments. Temperature range: -30 °C to 60 °C (-30 °C to 140 °F)

Digital

Thermo

DTR Digital room thermostat with temperature range 5 to 50 °C (41 °F to 122 °F) with in-built (internal) sensor. Intelligent regulation.

DTF Digital floor thermostat with temperature range 5 to 50 °C (41 °F to 122 °F) with external sensor, 16 A potential-free contact.

DTC Digital combined thermostat with room and floor sensor with temperature range 5 to 50 °C (41 °F to 122 °F), default programs.

TER

TER-9 2 temperature inputs, 2 outputs 8A changeover/ SPDT, 6 functions, in-built time switch clock, LCD with back light, galvanically sep. supply voltage AC 230 V or AC/DC 24V, 2 MODULE. Temperature range: -40 °C to 110 °C (-40 °C to 230 °F).

Accessories to thermostats

Telva It is an appropriate control unit for a wide range of thermostatic valves.

TC, TZ, Pt100 External temperature sensors for thermostats in lengths 3m, 6m, 12m (9.9', 19.7', 39.4') TC/TZ: thermistor NTC 12 kΩ/ 25 °C (77 °F) Pt: element Pt100 (only TER-3G).

Therموالve

ATV-1 Energy-saving digital thermostat for radiators, with temperature range 8 to 28 °C (48 °F to 82 °F).

Hygrostat

RHV-1 Hygro-thermostat for humidity monitoring and regulation in range 0.. 90 % RH.

Hygro-thermostat

RHT-1 Hygro-thermostat for temperature monitoring and regulation in range 0 to 60 °C (32 °F to 140 °F) and relative humidity monitoring and regulation in range 50..90%.

Type	Design	Type		Sensor		Supply				Temperature range	Hysteresis	Relative humidity	Designation	Page of catalogue	
		Analog	Digital	In-built	External	Type	AC 230V	AC 24V	AC/DC 24..240V						Galv. separated
TER-3A	1M-DIN	●	x	x	●	NTC	x	x	●	x	-30..10 °C (-22 °F to 50 °F)	0.5 - 5 °C (32.9 °F to 41 °F)	x	single thermostat into a switchboard with external sensor for temperature in cooling and against freezing	104
TER-3B	1M-DIN	●	x	x	●	NTC	x	x	●	x	0.. 40 °C (32 °F to 104 °F)	0.5 - 5 °C (32.9 °F to 41 °F)	x	single thermostat into a switchboards with external sensor for sensing room and operational temperature	104
TER-3C	1M-DIN	●	x	x	●	NTC	x	x	●	x	+30.. 70 °C (86 °F to 158 °F)	0.5 - 5 °C (32.9 °F to 41 °F)	x	single thermostat into a switchboards with external sensor for sensing temperature in devices (overheating...)	104
TER-3D	1M-DIN	●	x	x	●	NTC	x	x	●	x	0.. 60 °C (32 °F to 140 °F)	0.5 - 5 °C (32.9 °F to 41 °F)	x	single thermostat into a switchboard with external sensor for sensing operational temperature of machines and devices	104
TER-3E	1M-DIN	●	x	x	●	NTC	x	x	●	x	0.. 60 °C (32 °F to 140 °F)	1 °C (34 °F)	x	as TER-3D but with fixed hysteresis	105
TER-3F	1M-DIN	●	x	●	x	NTC	x	x	●	x	0.. 60 °C (32 °F to 113 °F)	1 °C (34 °F)	x	single thermostat into a switchboard with in-built sensor, monitors operational temperature in a switchboard	105
TER-3G	1M-DIN	●	x	x	●	Pt100	x	x	●	x	0.. 60 °C (32 °F to 140 °F)	0.5 - 5 °C (32.9 °F to 41 °F)	x	as TER-3D but with input for sensor Pt100	104
TER-3H	1M-DIN	●	x	x	●	NTC	x	x	●	x	-15.. 45 °C (5 °F to 113 °F)	0.5 - 5 °C (32.9 °F to 41 °F)	x	as TER-3A but with a different temperature range - for cooling and heating	104
TER-4	3M-DIN	●	x	x	●	NTC	●	●	x	●	-40.. 110 °C (-40 °F to 230 °F)	0.5 - 2.5 °C (32.9 °F to 37 °F)	x	two-state thermostat (2 inputs, 2 outputs), two independent or dependent thermostats, accurate setting, wide temperature range	106
TER-7	1M-DIN	●	x	x	●	PTC	x	x	●	x	x	Resistance 1.8-3.3 kΩ	x	thermist relay for protection of motor overheating, input designated for sensor PTC in-built in motor winding	110
TER-9	2M-DIN	x	●	x	●	NTC	●	●	x	●	-40.. 110 °C (-40 °F to 230 °F)	0.5 - 5 °C (32.9 °F to 41 °F)	x	multifunction (6thermo functions) digital thermostat with in-built time switch clock, 2 inputs/2 outputs	108
TEV-1	IP65 box	●	x	x	●	INTC	●	x	x	x	-20.. 20 °C (-4 °F to 68 °F)	1.5 °C (35 °F)	x	thermostat with "dead zone", control of heating and protection against freezing, box for outdoor use with IP65	114
TEV-2	IP65 box	●	x	x	●	NTC	●	x	x	x	-20.. 20 °C (-4 °F to 68 °F)	1.5 °C (35 °F)	x	single thermostat for regulation of heating, short sensor is a part of this device, protection degree IP65	115
TEV-3	IP65 box	●	x	x	●	NTC	●	x	x	x	5.. 35 °C (41 °F to 149 °F)	1.5 °C (35 °F)	x	as TEV-2 but potentiometer and indication are placed on front panel	115
TEV-4	IP65 box	x	x	x	●	NTC	●	x	x	x	-30.. 65 °C (-22 °F to 149 °F)	0.5 / 1.5 / 4 °C (32.9 / 35 / 39 °F)	x	single exterior thermostat for monitoring and regulation of temperature in demanding environments	116
ATR	ELEGANT	●	x	●	x	NTC	●	x	x	x	5.. 40 °C (41 °F to 104 °F)	1 °C (34 °F)	x	room analog thermostat line THERMO for mounting into a wiring box	111
ATF	ELEGANT	●	x	x	●	NTC	●	x	x	x	5.. 50 °C (41 °F to 122 °F)	1 °C (34 °F)	x	floor analog thermostat line THERMO for mounting into a wiring box	111
ATC	ELEGANT	●	x	●	●	NTC	●	x	x	x	5.. 50 °C (41 °F to 122 °F)	1 °C (34 °F)	x	room and floor (combined) analog thermostat line THERMO for mounting into a wiring box	111
DTR	ELEGANT	x	●	●	x	NTC	●	x	x	x	5.. 50 °C (41 °F to 122 °F)	0.5 - 1 °C (32.9 °F to 34 °F)	x	room digital thermostat line THERMO for mounting into a wiring box	112
DTF	ELEGANT	x	●	x	●	NTC	●	x	x	x	5.. 50 °C (41 °F to 122 °F)	0.5 - 1 °C (32.9 °F to 34 °F)	x	floor digital thermostat line THERMO for mounting into a wiring box	112
DTC	ELEGANT	x	●	●	●	NTC	●	x	x	x	5.. 50 °C (41 °F to 122 °F)	0.5 - 1 °C (32.9 °F to 34 °F)	x	room and floor (combined) digital thermostat line THERMO for mounting into a wiring box	112
RHT-1	1M-DIN	●	x	●	x	built-in	x	x	●	x	0.. 60 °C (32 °F to 140 °F)	H - 4 % T- 2.5 °C (36.5 °F)	50.. 90%	hygro-thermostat for temperature monitoring and regulation in range 0 °C to +60 °C (32 °F to 140 °F) and relative humidity in range 50.. 90%	117
RHV-1	IP65	●	x	●	x	built-in	x	x	x	x	-30.. 60 °C (-22 °F to 140 °F)	2%, 3%, 4%	0... 30 % RH 30... 60 % RH 60... 90 % RH	hygro-thermostat for humidity monitoring and regulation in range 0.. 90 % RH	118
ATV-1	valve	x	●	●	x	built-in	x	x	x	x	8.. 28 °C (46 °F to 82 °F)	x	x	thermostatic direction valves, temperature regulation +8 to +28 °C (46 °F to 82 °F)	113



EAN code
 TER-3A: 8595188138390
 TER-3B: 8595188138406
 TER-3C: 8595188138413
 TER-3D: 8595188138420
 TER-3G: 8595188138451
 TER-3H: 8595188138468

Technical parameters		TER-3
Function:	single level	
Supply terminals:	A1-A2	
Voltage range:	AC/DC 24 - 240V (galvanically unseparated) (AC 50-60Hz)	
Burden:	max. 2 VA / 1 W	
Max. dissipated power (Un + terminals):	2.5 W	
Operating range:	- 15 %; + 10 %	
Measuring circuit		
Measuring terminals:	T1 - T1	
Temperature range: (according to product type sensitivity)	TER-3A: -30 °C to 10 °C (-22 °F to 50 °F) TER-3B: 0 °C to 40 °C (32 °F to 104 °F) TER-3C: 30 °C to 70 °C (86 °F to 158 °F) TER-3D: 0 °C to 60 °C (32 °F to 140 °F) TER-3G: 0 °C to 60 °C (32 °F to 140 °F) TER-3H: -15 °C to 45 °C (5 °F to 113 °F)	
Hysteresis:	adjustable in range 0.5 to 5 °C / 0.9 to 9 °F	
Sensor:	external, thermistor NTC, except for TER-3C (Pt100)	
Sensor fault indication (short circuit / disconnect):	flashing red LED	
Accuracy		
Setting accuracy (mech.):	5 %	
Switching difference:	0.5 °C / 0.9 °F	
Temperature dependance:	< 0.1 % / °C (< 0.1 % / °F)	
Output		
Number of contacts:	1x NO-SPST (AgSnO ₂)	
Current rating:	16A / AC1, 10A / 24V DC	
Breaking capacity:	4000 VA / AC1, 300 W / DC	
Switching voltage:	250 V AC1 / 24 V DC	
Output indication:	red LED	
Mechanical life:	3x10 ⁷	
Electrical life (AC1):	0.7x10 ⁵	
Other information		
Operating temperature:	-20 °C to 55 °C (-4 °F to 131 °F)	
Storage temperature:	-30 °C to 70 °C (-22 °F to 158 °F)	
Electrical strength:	2.5 kV (supply - output)	
Operating position:	any	
Mounting:	DIN rail EN 60715	
Protection degree:	IP40 from front panel / IP10 terminals	
Overvoltage category:	III.	
Pollution degree:	2	
Max. cable size (mm ²):	solid wire max. 2x 2.5 or 1x 4 with sleeve max. 1x 2.5 or 2x 1.5 (AWG 12)	
Dimensions:	90 x 17.6 x 64 mm (3.5" x 0.7" x 2.5")	
Weight:	64 g (2.3 oz.); TER-3G: 68 g (2.4 oz.)	
Standards:	EN 60730-2-9, EN 61010-1	

Example of an order

Please specify a type of thermostat in your order (TER-3A, TER-3B .. or TER-3H) types differ in temperature range and supply voltage.

- Single thermostat for temperature monitoring and regulation in range -30 °C to +70 °C (-22 °F to 158 °F) in six ranges.
- It can be used for monitoring temperature e.g. in switchboards, heating systems, cooling systems, liquids, radiators, motors, devices, open spaces, etc.
- Function of short-circuit or sensor disconnection monitoring.
- Possibility to set function "heating"/"cooling" (setting is done by DIP switch).
- Adjustable hysteresis (sensitivity), switching by potentiometer in range 0.5 to 5 °C / 0.9 to 9 °F
- Choice of external temperature sensors with double insulation in standard lengths 3, 6 and 12 m (9.8', 19.7' and 39.4').
- It is possible to place sensor directly on terminal block - for temperature monitoring in a switchboard or in its surroundings.
- Multivoltage supply AC/DC 24 - 240 V, not galvanically separated.
- Output contact 1x NO - SPST 16 A / 250 V AC1.
- Red LED indicates status of output, green LED indicates energization of the device.
- 1-MODULE, DIN rail mounting.

Description

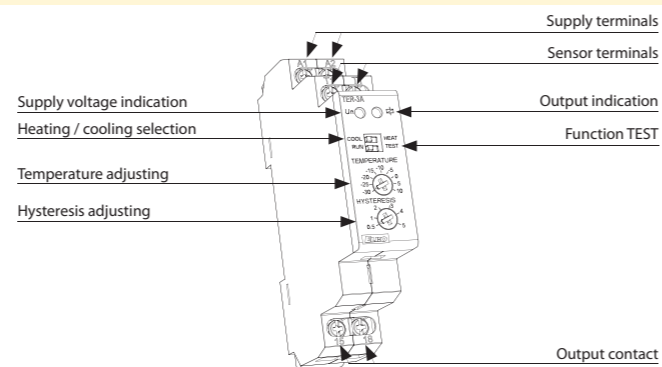

Function

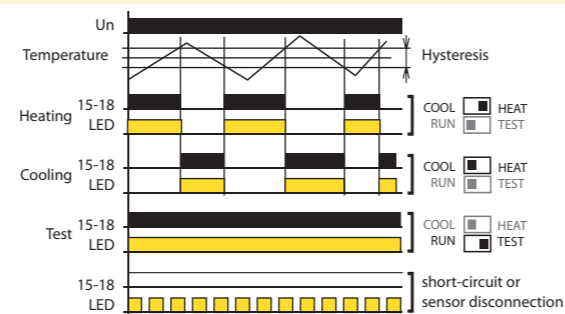

It is a single but practical thermostat with separated sensor for monitoring temperature. Device is placed in a switchboard and external sensor senses temperature of required space, object, or liquid. Supply is not galvanically separated from sensor. Sensor is double insulated. Maximal length of delivered sensor is 12 m / 39.4'. device has in-built indication of sensor damage, which means that in case of short-circuit or disconnection red LED flashes. Thanks to adjustable hysteresis, it is advantageous to regulate width of the range and thus define sensitivity of load switching. Sensed temperature is decreased by set hysteresis. When installing it is necessary to keep in mind that hysteresis is increased by temperature gradient between sensor's jacket and thermistor.

Connection

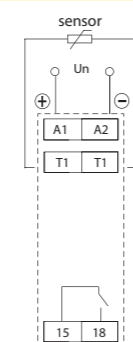

Symbol

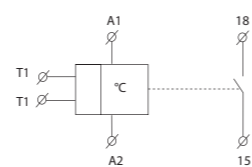

EAN code
 TER-3E: 8595188138437
 TER-3F: 8595188138444

Technical parameters		TER-3E	TER-3F
Function:	single level		
Supply terminals:	A1-A2		
Voltage range:	AC/DC 24 - 240 V (AC 50 - 60 Hz)		
Burden:	max. 2 VA / 1 W		
Operating range:	2.5 W		
Measuring terminals:	- 15 %; + 10 %		
Temperature range:	T1 - T1		
Hysteresis:	x		
Sensor:	0 to +60 °C / (32 °F to 140 °F)		
Sensor fault indic. (short-circuit / disconnection):	fixed 1 °C / (1.8 °F)		
Accuracy	thermistor NTC in-built		
Setting accuracy (mech.):	flashing red LED		
Switching difference:	5 %		
Temperature dependance:	0.5 °C (0.9 °F)		
Output	< 0.1 % / °C (°F)		
Number of contacts:	1x NO-SPST (AgSnO ₂)		
Current rating:	16A / AC1, 10A / 24V DC		
Breaking capacity:	4000 VA / AC1, 300 W / DC		
Switching voltage:	250 V AC1 / 24 V DC		
Output indication:	red LED		
Mechanical life:	3x10 ⁷		
Electrical life (AC1):	0.7x10 ⁵		
Other information			
Operating temperature:	-20 °C to 55 °C (-4 °F to 131 °F)		
Storage temperature:	-30 °C to 70 °C (-22 °F to 158 °F)		
Mounting:	2.5 kV (supply - output)		
Protection degree:	any		
Overvoltage category:	DIN rail EN 60715		
Pollution degree:	IP40 from front panel / IP10 terminals		
Max. cable size (mm ²):	III.		
Dimensions:	solid wire max. 2x 2.5 or 1x 4 with sleeve max. 1x 2.5 or 2x 1.5 (AWG 12)		
Weight:	90 x 17.6 x 64 mm (3.5" x 0.7" x 2.5")		
Standards:	64 g (2.3 oz.) 60 g (2.1 oz.) EN 60730-2-9, EN 61010-1		

Example of an order

Please specify a type of thermostat in your order (TER-3E, TER-3F).

- Single thermostat for temperature monitoring and regulation in range 0 to +60 °C (32 °F to 140 °F).
- It can be used for temperature monitoring e.g. in switchboards, heating systems, liquids, radiators, motors, devices, open spaces, etc.
- Fixed hysteresis at 1 °C / (1.8 °F).
- TER-3E: choice of external temperature sensors with double insulation in standard lengths 3 (9.8'), 6 (19.7') and 12 m (39.4').
- TER-3F: sensor is a part of device, serves for monitoring temperature in a switchboard.
- Supply voltage AC / DC 24 - 240 V.
- Output contact 1x NO-SPST 16 A / 250 V AC1.
- Output status is indicated by red LED.
- 1-MODULE, DIN rail mounting.

Description

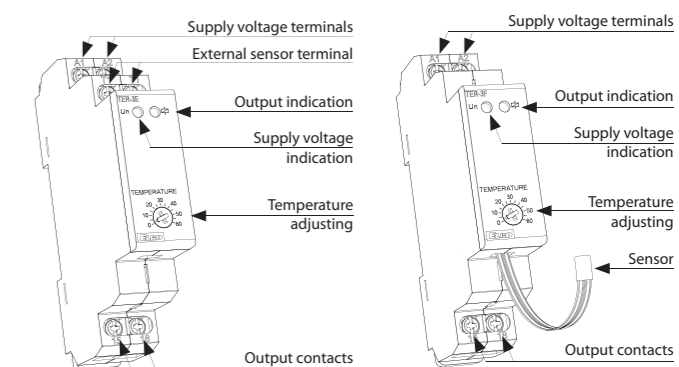

Function

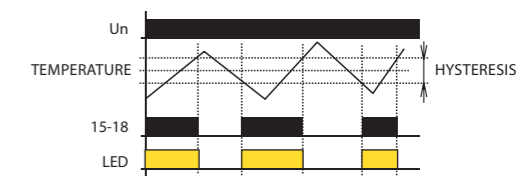

It is a single thermostat for temperature monitoring with separated sensor (except for TER-3F). Device is located in a switchboard and external sensor senses temperature of required space, object or liquid. Supply is not galvanically separated from sensor but sensor is double insulated. Maximal length of sensor cable is 12 m (39.4'). Temperature sensing is decreased by set hysteresis. When installing it is necessary to keep in mind that hysteresis is increased by temperature gradient between sensor's jacket and thermistor.

Connection

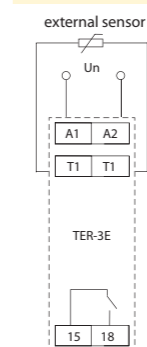

Symbol

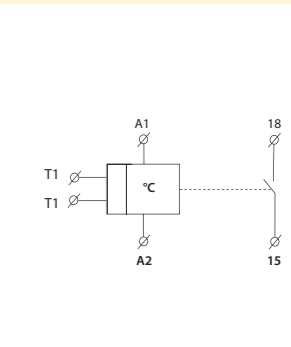



EAN code
TER-4 / 230V: 8594030337806
TER-4 / 24V: 8594030338148

Technical parameters		TER-4	
Function:	double thermostat		
Supply terminals:	A1-A2		
Voltage range:	AC 230 V (AC 50-60 Hz), AC/DC 24V galvanically separated		
Burden max.:	5 VA / 2.5 W (AC 230 V), 2 VA / 1.4 W (AC/DC 24 V)		
Max. dissipated power (Un + terminals):	5.5 W		
Supply voltage tolerance:	- 15 %; + 10 %		
Measuring circuit		T1-T1 and T2-T2	
Measuring terminals:	T1-T1 and T2-T2		
Temperature ranges (set via switch individually for each level):	-40 .. -25 °C (-458 .. -13 °F)	+35 .. +50 °C (95 .. 122 °F)	
	-25 .. -10 °C (-13 .. 14 °F)	+50 .. +65 °C (122 .. 149 °F)	
	-10 .. +5 °C (14 .. 41 °F)	+65 .. +80 °C (149 .. 176 °F)	
	+5 .. +20 °C (41 .. 68 °F)	+80 .. +95 °C (176 .. 203 °F)	
	+20 .. +35 °C (68 .. 95 °F)	+95 .. +110 °C (203 .. 230 °F)	
Fine temperature setting:	0-15 °C, in selected range		
Hysteresis for T1:	adjustable, 0.5 or 2.5 °C / 0.9 or 4.5 °F (DIP switch)		
Hysteresis for T2:	adjustable, 0.5 or 2.5 °C / 0.9 or 4.5 °F (DIP switch)		
Sensor:	thermistor NTC 12 kΩ / 25 °C (77 °F)		
Sensor failure indication:	yellow LED + Red LED flashes		
Accuracy			
Setting accuracy (mech.):	5 %		
Temperature dependance:	< 0.1 % / °C (°F)		
Output			
Number of contacts:	2x changeover / SPDT (AgNi / Silver Alloy)		
Current rating:	16A / AC1		
Breaking capacity:	4000 VA / AC1, 384 W / DC		
Inrush current:	30 A / < 3 s		
Switching voltage:	250 V AC1 / 24 V DC		
Output indication:	red LED		
Mechanical life:	3x10 ⁷		
Electrical life (AC1):	0.7x10 ⁵		
Other information			
Operating temperature:	-20 °C to 55 °C (-4 °F to 131 °F)		
Storage temperature:	-30 °C to 70 °C (-22 °F to 158 °F)		
Electrical strength:	4 kV (supply - output)		
Operating position:	any		
Mounting:	DIN rail EN 60715		
Protection degree:	IP40 from front panel / IP20 terminals		
Overvoltage category:	III.		
Pollution degree:	2		
Max. cable size (mm ²):	solid wire max. 1x 2.5 or 2x 1.5 / with sleeve max. 1x 1.5 (AWG 12)		
Dimensions:	90 x 52 x 65 mm (3.5" x 2" x 2.6")		
Weight:	240 g / 8.9 oz (230 V), 146 g / 5.4 oz (24 V)		
Standards:	EN 60730-2-9, EN 61010-1		

- Double thermostat for temperature monitoring and regulation over a wide range of temperatures
- Temperature range switch and fine temperature setting for each thermostat
- Usable for temperature monitoring in switchboards, heating or cooling systems, motors, liquids, open spaces, etc.
- Galvanically isolated power supply AC 230V or AC / DC 24V
- 2 inputs for temperature sensors NTC 12k / 25 °C
- Setting independent or dependent thermostat function (see function description)
- Short-circuit monitoring or sensor interruption
- Heating / cooling function selection
- Adjustable switching hysteresis (sensitivity)
- Two output relays (for each level independent)
- Output contact 2x changeover 16A / 250V AC1
- Output status indication and LED sensor fault indication
- 3-MODULE, DIN rail mounting

Description

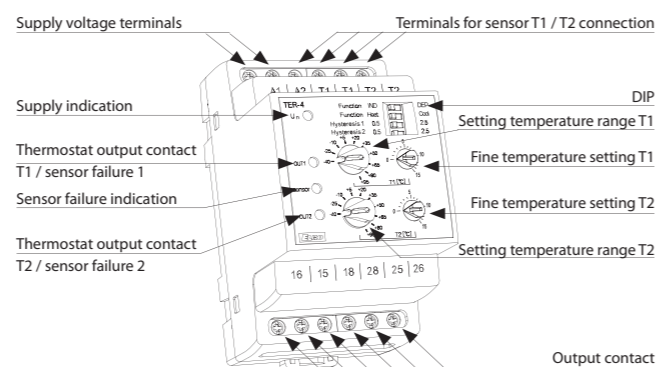

Description and importance of DIP switches

Function iND	<input type="checkbox"/>	DEP	← Independent / dependent function of thermostats
Function Heat	<input type="checkbox"/>	Cool	← Heating / cooling function
Hysteresis 1 0.5	<input type="checkbox"/>	2.5	← Hysteresis of thermostat T1
Hysteresis 2 0.5	<input type="checkbox"/>	2.5	← Hysteresis of thermostat T2

Connection

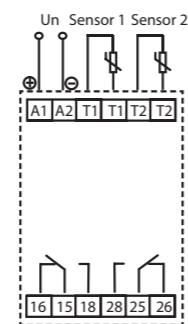

Symbol

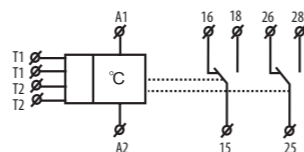

Function

Each thermostat has its own temperature sensor, coarse and fine temperature setting, hysteresis setting and its output relay. The set temperature is set as the sum of the selected temperature range and fine temperature setting.

Example: Required temperature + 25 °C
Set range + 20 °C
Fine setting 5 °C

The device monitors the failure status of each sensor (short circuit or interruption) - if the sensor fails, the yellow LED is lit and the corresponding red LED flashes. The relevant relay is disconnected when it fails.

The device can also be operated as a single thermostat (single sensor). In this case, a 10kΩ resistor (part of the product package) must be connected to the unused input.

Independent thermostat function

The device acts as 2 single simple thermostats

Dependent function of thermostats

The thermostats are connected "in series" - i.e. the thermostat 1 is blocked by thermostat 2. This can be used, for example, when thermostat 1 is operational and the thermostat 2 is blocked (emergency - for example, when overheating the device).

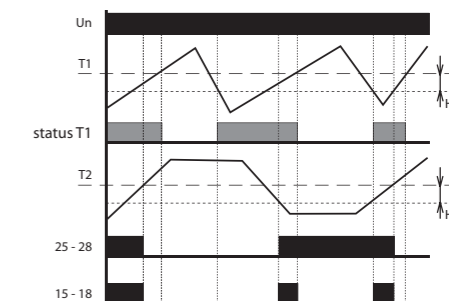
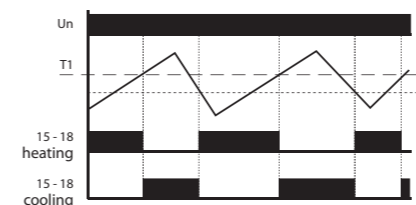



EAN code
TER-9 /230V: 8595188124478
TER-9 /24V: 8595188129190

Technical parameters		TER-9
Supply		
Number of function:	6	
Supply terminals:	A1 - A2	
Voltage range:	AC 230 V (AC 50 - 60 Hz) galvanically separated, AC/DC 24V galvanically unseparated	
Burden:	max. 4 VA / 0.5 W	
Max. dissipated power (Un + terminals):	3 W	
Operating range:	-15 %; +10 %	
Type backup battery:	CR 2032 (3V)	
Measuring circuit		
Measuring terminals:	T1-T1 and T2-T2	
Temperature range:	-40.. +110 °C (-40.. +230 °F)	
Hysteresis (sensitivity):	in an adjustable range 0.5.. 5 °C (0.9.. 9 °F)	
Difference temperature:	adjustable 1.. 50 °C (34..122 °F)	
Sensor:	thermistor NTC 12 kΩ at 25 °C (77 °F)	
Sensor failure indication:	displayed on the LCD	
Accuracy		
Measuring accuracy:	5 %	
Repeat accuracy:	< 0.5 °C (0.9 °F)	
Temperature dependence:	< 0.1 % / °C (°F)	
Output		
Number of contacts:	1x changeover for each output / SPDT, (AgNi)	
Current rating:	8 A / AC1	
Max. breaking capacity:	2000 VA / AC1, 240 W / DC	
Switching voltage:	250 V AC1 / 30 V DC	
Output indication:	symbol ON/OFF	
Mechanical life:	1x10 ⁷	
Electrical life (AC1):	1x10 ⁵	
Time circuit		
Power back-up:	up to 3 year	
Accuracy:	max. ±1 s per day, at 23°C (73.4 °F)	
Min. switching interval:	1 min	
Data stored for:	min. 10 years	
Program circuit		
Number of memory places:	100	
Program:	daily, weekly, yearly	
Data readout:	LCD display, with back light	
Other information		
Operating temperature:	-10 °C to 55 °C (14 °F to 131 °F)	
Storage temperature:	-30 °C to 70 °C (-22 °F to 158 °F)	
Electrical strength:	4 kV (power supply - output)	
Operating position:	any	
Mounting:	DIN rail EN 60715	
Protection degree:	IP20 terminals, IP40 from front panel	
Overvoltage category:	III.	
Pollution degree:	2	
Max. cable size (mm ²):	solid wire max. 1x 2.5 or 2x1.5 / with sleeve max. 1x2.5 (AWG 12)	
Dimensions:	90 x 35 x 64 mm (3.5 x 1.4 x 2.5")	
Weight:	150 g / 5.3 oz. (230 V) 113 g / 4 oz. (24 V)	
Standards:	EN 61812-1; EN 61010-1; EN 60730-2-9; EN 60730-1; EN 60730-2-7	

- Digital thermostat with 6 functions and built-in time switch clock with day, week and year program. You can also limit temperature functions and courses this way in real time.
- Complex control of home and water heating, solar heating, etc.
- Two thermostats in one, two temperature inputs, two outputs with dry contact.
- Maximum universal and variable thermostat including all ordinary thermostat functions.
- Functions: two independent thermostats, dependent thermostat, differential thermostat, two level thermostat, zone-based thermostat, dead zone thermostat.
- Program setting of output functions, calibration of sensors according to reference temperature (offset).
- The thermostat is subject to the digital clock programs.
- Wide operating range of temperature settings, the possibility of measuring in °C and °F.
- Clear display of set and measured data on a backlit LCD.
- Power supply: AC 230 V or 24 V AC/DC (based on type of device).
- The time switch clock has a battery backup, which retains data in case of a power outage (reserve backup time - up to 3 years).
- Easy replacement of the backup battery through the plug-in module, no disassembling is required.
- Output contact 1x changeover / SPDT 8 A / 250 V AC1 for each output.
- 2-MODULE, DIN rail mounting.

Device description

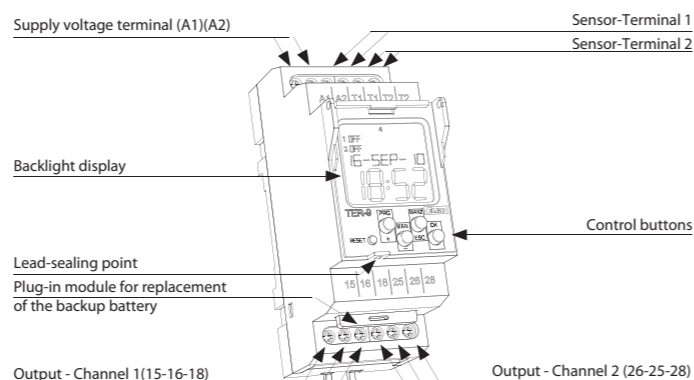

Description of visual elements on the display

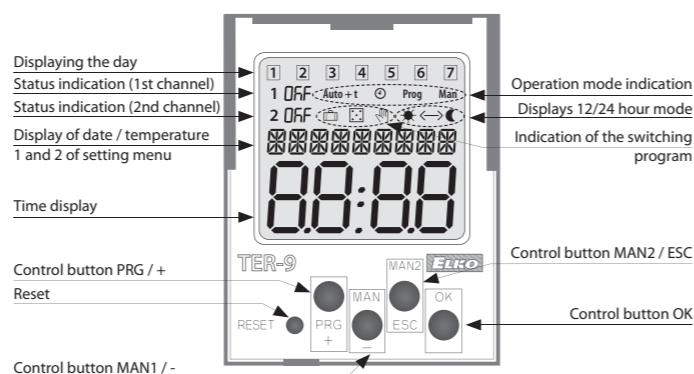

Connection Symbol

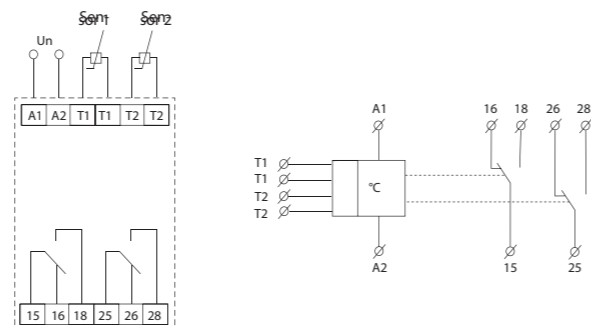

1.2 independent single-stage thermostats

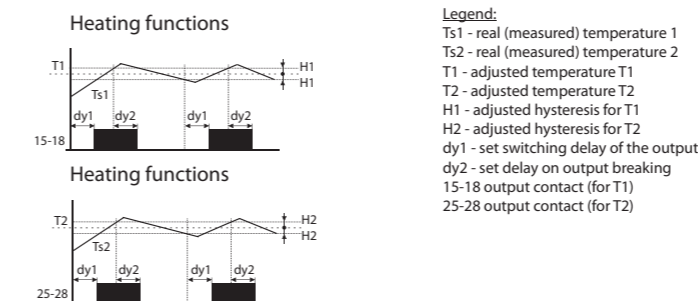

Legend:
Ts1 - real (measured) temperature 1
Ts2 - real (measured) temperature 2
T1 - adjusted temperature T1
T2 - adjusted temperature T2
H1 - adjusted hysteresis for T1
H2 - adjusted hysteresis for T2
dy1 - set switching delay of the output
dy2 - set delay on output breaking
15-18 output contact (for T1)
25-28 output contact (for T2)

Classic function of thermostat, output contact switched until adjusted temperature is reached. Hysteresis eliminates frequent switching - output oscillation.

2. Depending functions of 2 thermostats

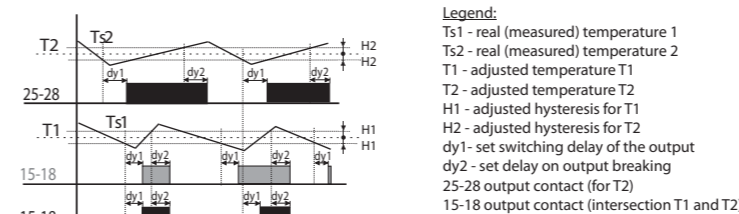

Legend:
Ts1 - real (measured) temperature 1
Ts2 - real (measured) temperature 2
T1 - adjusted temperature T1
T2 - adjusted temperature T2
H1 - adjusted hysteresis for T1
H2 - adjusted hysteresis for T2
dy1 - set switching delay of the output
dy2 - set delay on output breaking
25-28 output contact (for T2)
15-18 output contact (intersection T1 and T2)

Output 15-18 is closed, if temperature of both thermostats is below an adjusted level. When any thermostat reaches adjusted level, the contact 15-18 opens.

Serial inner connection of thermostats (logic function AND).

3. Differential thermostat

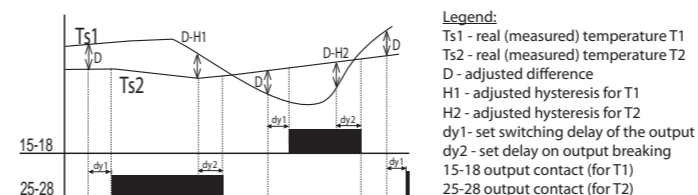

Legend:
Ts1 - real (measured) temperature T1
Ts2 - real (measured) temperature T2
D - adjusted difference
H1 - adjusted hysteresis for T1
H2 - adjusted hysteresis for T2
dy1 - set switching delay of the output
dy2 - set delay on output breaking
15-18 output contact (for T1)
25-28 output contact (for T2)

Switching of output corresponds with input, which has lower temperatures when difference is exceeded.

Differential thermostat is used for keeping two identical temperature e.g. in heating systems (boiler and reservoir), solar systems (collector - reservoir, exchanger), water heating (water heater, water distribution) etc.

4. 2-stage thermostat

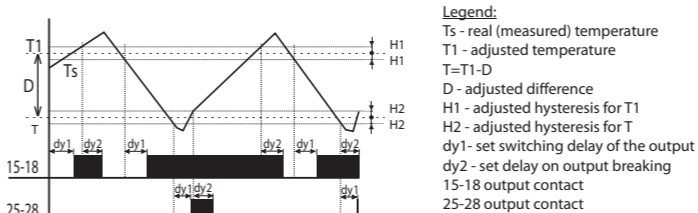

Legend:
Ts - real (measured) temperature
T1 - adjusted temperature
T=T1-D
D - adjusted difference
H1 - adjusted hysteresis for T1
H2 - adjusted hysteresis for T
dy1 - set switching delay of the output
dy2 - set delay on output breaking
15-18 output contact
25-28 output contact

Typical example of use for two-stage thermostat is e.g. in boiler-room, where there are two boilers from which one is main and the other one is auxiliary. The main boiler is managed according to set temperature and auxiliary boiler is switched in case temperature falls under set difference. Thus it helps to the main boiler in case outside temperature dramatically falls.

In the range of set difference (D) output 15-18 functions as normal thermostat to input 1 (type 1). In case temperature falls under set difference, second output switches too.

5. Thermostat with "WINDOW"

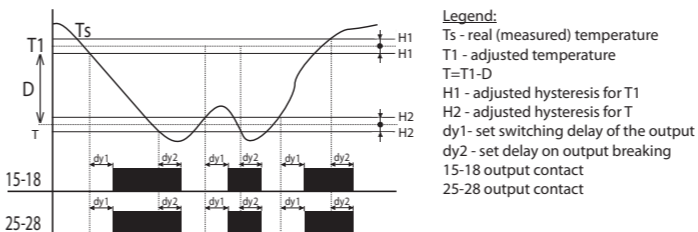

Legend:
Ts - real (measured) temperature
T1 - adjusted temperature
T=T1-D
D - adjusted difference
H1 - adjusted hysteresis for T1
H2 - adjusted hysteresis for T
dy1 - set switching delay of the output
dy2 - set delay on output breaking
15-18 output contact
25-28 output contact

Output is closed (heating) only if temperature is within adjusted range. If temperature is out of range, the contact opens. T is set as T1-D.

The function is used for protection of gutters against freezing.

6. Thermostat with dead zone

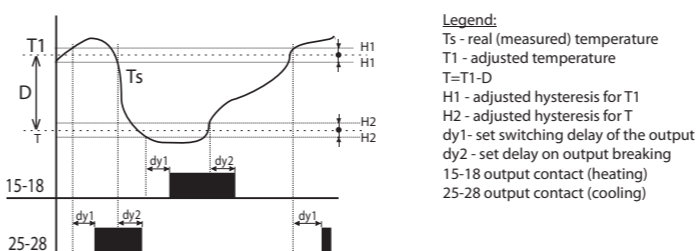

Legend:
Ts - real (measured) temperature
T1 - adjusted temperature
T=T1-D
D - adjusted difference
H1 - adjusted hysteresis for T1
H2 - adjusted hysteresis for T
dy1 - set switching delay of the output
dy2 - set delay on output breaking
15-18 output contact (heating)
25-28 output contact (cooling)

In case of thermostat with a „dead zone“, it is possible to set temperature T1 and a difference (respectively a width of dead zone D). If temperature is higher than T1, output contact of cooling switches ON; if the temperature gets below T1, the contact switches OFF.

If the temperature gets below temperature T, the contact of heating switches ON and it switches OFF when temperature T is exceeded. This function can be used for example for automatic air warming and cooling in ventilation so the sit is always within the range T1 and T.



EAN code
TER-7: 8595188137164

Technical parameters		TER-7
Function:	monitoring temperature of motor winding	
Supply terminals:	A1-A2	
Voltage range:	AC/DC 24 - 240 V (AC 50 - 60 Hz)	
Burden:	max. 2 VA / 1 W	
Max. dissipated power (Un + terminals):	2.5 W	
Operating range:	-15 %; +10 %	
Measuring circuit		
Measuring terminals:	Ta-Tb	
Cold sensor resistance:	50 Ω - 1.5 kΩ	
Upper level:	3.3 kΩ	
Bottom level:	1.8 kΩ	
Sensor:	PTC temperature of motor winding	
Sensor failure indication:	blinking red LED	
Accuracy		
Accuracy in repetition:	< 5 %	
Switching difference:	± 5 %	
Temperature dependance:	< 0.1 % / °C	
Output		
Number of contacts:	2x changeover / DPDT (AgNi / Silver Alloy)	
Current rating:	8 A / AC1	
Breaking capacity:	2000 VA / AC1, 192 W / DC	
Inrush current:	10 A / < 3 s	
Switching voltage:	250 V AC1 / 24 V DC	
Mechanical life:	3x10 ⁷	
Electrical life (resistive):	0.7x10 ⁵	
Other information		
Operating temperature:	-20 °C to 55 °C (-4 °F to 131 °F)	
Storage temperature:	-30 °C to 70 °C (-22 °F to 158 °F)	
Electrical strength:	4 kV (supply - output)	
Operating position:	any	
Mounting:	DIN rail EN 60715	
Protection degree:	IP40 from front panel / IP20 terminals	
Overvoltage category:	III.	
Pollution degree:	2	
Max. cable size (mm ²):	solid wire max. 1x 2.5 or 2x 1.5 / with sleeve max. 1x 2.5 (AWG 12)	
Dimensions:	90 x 17.6 x 64 mm (3.5" x 0.7" x 2.5")	
Weight:	71 g (2.5 oz.)	
Standards:	EN 60730-2-9, EN 61010-1	

Note

Sensors could be in series in abide with conditions in technical specification - switching limits.

Warning:

In case of supply from the main, neutral wire must be connected to terminal A2!

- It monitors motor coil temperature.
- Fixed levels of switching.
- PTC sensor is used for sensing, it is in-built in motor winding by its manufacturer or there is used an external PTC sensor.
- MEMORY function - relay is blocked in an error state until operator intervention (press RESET button).
- RESET of faulty state:
 - a) button on the front panel
 - b) by external contact (remote by two wires).
- Function of short-circuit or sensor disconnection monitoring, red LED flashing indicates faulty sensor.
- Output contact: 2x changeover / DPDT 8 A / 250 V AC1.
- Red LED shines and indicates exceeded temperature.
- Terminals of sensor are galvanically separated, they can be shorted out by terminal PE without damaging the device.
- Multivoltage supply AC/DC 24 - 240 V.
- 1-MODULE, DIN rail mounting.

Description

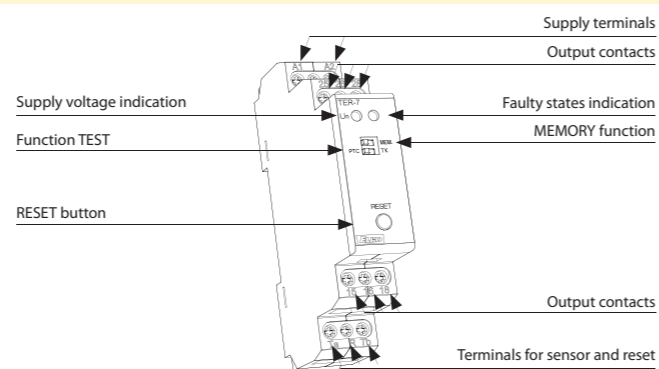

Function

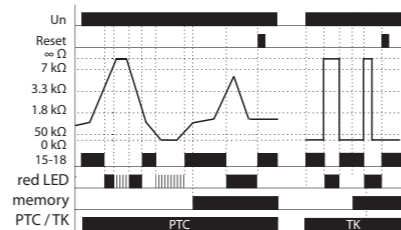

The device controls temperature of motor winding with PTC thermistor which is mostly placed in motor winding or very close to it. Resistance of PTC thermistor run to max 1.5 kΩ in cold stage. By temperature increase the resistance goes strongly up and by overrun the limit of 3.3 kΩ the contact of output relay switch off - mostly contactor controlling a motor. By temperature decrease and thereby decrease of thermistor resistance under 1.8 kΩ the output contact of relay again switches on. The relay has function "Control of sensor fault". This controls interruption or disconnection of sensor. When switch is in position "TK" monitoring of faulty sensor is not functional - it is possible to connect bimetal sensor with only 2 states: ON or OFF. The device can work with bi-metal sensor in this position. Other safety unit is function "Memory". By temperature overrun (and output switches off) the output is hold in faulty stage until service hit. This bring the relay to normal stage (with RESET button) on front panel or by external contact (remote).

Connection

Symbol

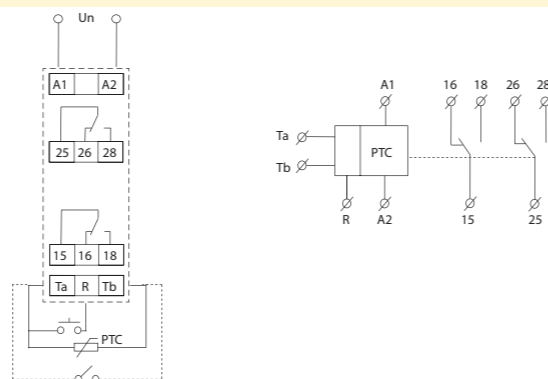

EAN code - DEVICE:
ATR: 8595188125000
ATF: 8595188130165
ATC: 8595188130172
To devices is necessary to order additionally - frame in design ELEGANT and external sensor (except ATR)

EAN code - SET:
ATR, white frame Elegant: 8595188136228
ATF, white frame Elegant, termosensor TC-3m: 8595188135870
ATC, white frame Elegant, termosensor TC-3m: 8595188135887

Technical parameters		ATR	ATF	ATC
Supply				
Power supply and tolerance:	AC 230 V ± 10 %			
Consumption, frequency:	6.5 VA / 50 - 60 Hz			
Measuring				
Temperature range:	5 to 40 °C (41 °F to 104 °F)	5 to 50 °C (41 °F to 122 °F)		
Accuracy:	± 2 °C / 36 °F			
Hysteresis:	± 1 °C / 34 °F			
Temperature sensor:	room	floor	room + floor	
Night decline:	adj. ± 7 °C / 45 °F	adj. ± 10 °C / 50 °F	fix -5 °C / 41 °F	
Offset / calibration:	adj. ± 7 °C / 45 °F		adj. ± 10 °C / 50 °F	
Setting				
Room temperature setting:	main knob	x	main knob	
Floor temperature setting:	x	main knob	auxiliary button 2	
Offset setting:	auxiliary button 1			
Night decline setting:	auxiliary button 2		x	
Night decline switching:	internal / external	internal pushbutton		
Display				
Power supply indication:	green LED 1			
Output ON indication:	red LED 1			
Night decline indication:	red / orange LED 2	red LED 2		
Indication of faulty floor sensor:	x	LED 1 flashing		
Indication- exceeded temp. / ext. sensor:	x		LED 1 flashing	
Output				
Type:	potential-free contact NO-SPST, material of contact - AgNi			
Max. loadability:	16 A / 250 V, 4000 VA for AC1			
Contact separation:	galvanic			
Mechanical life:	3x10 ⁷			
Electrical life (AC1):	0.7x10 ⁵			
Other information				
Operating temperature:	-10 °C to 55 °C (14 °F to 131 °F)			
Storage temperature:	-20 °C to 70 °C (-4 °F to 158 °F)			
Electrical strength:	4 kV			
Mounting:	installation box with min. depth 30 mm / 1.18", Ø min. 65 mm / 2.6"			
Protection degree:	IP30 in standard conditions*			
Max. cable size (mm ²):	solid wire 1x 2.5 / 1.5 with sleeve (AWG 12)			
Dimensions:	84 x 89 x 56.4 mm (3.3" x 3.5" x 2.22")			
Weight:	110 g (3.9 oz.)			
Standards:	EN 60730-2-9, EN 61010-1			

* see page 41

- **ATR - Analog Thermo Room:**
 - Room thermostat with temperature range 5 to 40 °C (41 °F to 104 °F) with a built-in sensor.
- **ATF - Analog Thermo Floor:**
 - Floor thermostat with temperature range 5 to 50 °C (41 °F to 122 °F) with external sensor.
 - Function „temporary temperature change“ in range ±10 °C (50 °F) (decreasing / increasing temperature).
- **ATC - Analog Thermo Combined:**
 - Room and floor thermostat, sensors are connected in series and block each other.
 - Function „temporary temperature change“, fix -5 °C / 23 °F (night decline).
 - Temperature range 5 to 50 °C (41 °F to 122 °F) for both sensors, adjustable separately.
 - It is possible to use it without external sensor.
- **ATR, ATF, ATC**
 - Night decline is activated by a pushbutton on device or external contact (only ATR).
 - Night decline setting is done by an auxiliary button 2 (under main knob, only ATR/ATF).
 - Offset setting (calibration ± 10 °C / 50 °F) with „known“ thermometer.
 - External sensor (TC-3.3 m / 9.84') is a part of delivery (only ATF/ATC), it is possible to extend its length up to 100 m (328').
 - Design ELEGANT, wide range of colors, possibility to combine more frames together.

Description

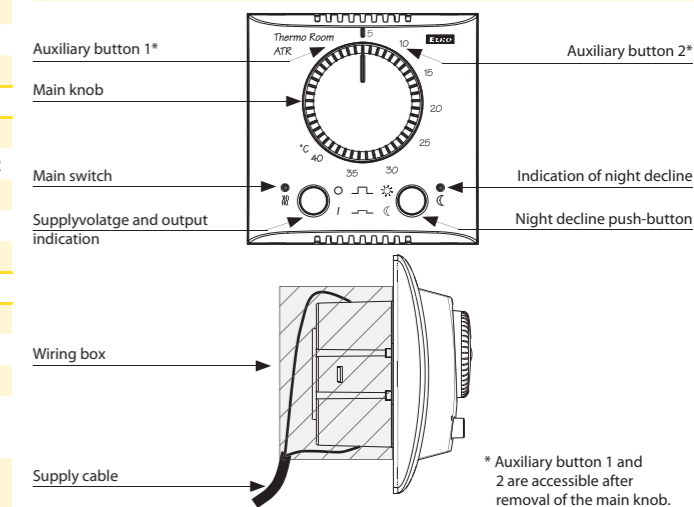

Connection

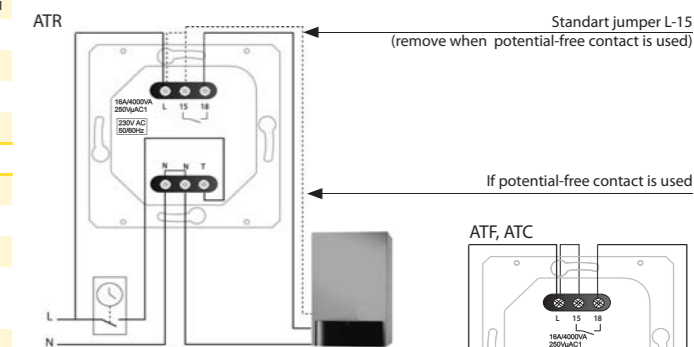

Design



Complete offer of switching devices line ELEGANT can be found in an individual catalogue ELEGANT Home switches, which can be sent to you upon request.



EAN code - DEVICE: DTR: 8595188125017
 DTF: 8595188135924
 DTC: 8595188135931
 To devices is necessary to order additionally - frame in design ELEGANT and external sensor (except DTR)

EAN code - SET: DTR, white frame Elegant: 8595188136235
 DTF, white frame Elegant, termosensor TC-3m: 8595188135863
 DTC, white frame Elegant, termosensor TC-3m: 8595188135856

Technical parameters	DTR	DTF	DTC
Supply			
Power supply and tolerance:	AC 230 V ± 15 %		
Consumption, frequency:	1.5 VA / 50 - 60 Hz		
Backup:	rechargeable accumulator LIR2032 (40 mAh) charging time from 0 to 100 %: 3 hours backup time when capacity is 100 %: 72 hours		
Measuring			
Temperature range:	5 to 50 °C (41 to 122 °F)		
Accuracy:	± 0.5 °C (± 32.9 °F)		
Hysteresis:	adjustable 0.5 °C or 1 °C (32.9 or 33.8 °F)		
Temperature sensor:	room (internal)	floor (external)	room (internal) and floor (external)
Adjusting			
Min. temperature cycle:	0.5 °C (32.9 °F)		
Min. time cycle:	10 min.		
Number of programs:	4; pre- set program 1		
Number of events:	2 - 6 in a program		
Offset / calibration:	adjustable ± 0.5 °C (32.9 °F)		
Display			
LCD display:	26 x 24 mm, with backlight (ON or OFF permanently)		
Displaying date:	current time, set / current temperature, day in a week, output status		
Output indication:	red LED and symbol on LCD		
Output			
Type:	potential-free contact NO - SPST, material of contact - AgNi (Silver Allow)		
Max. loadability:	16 A / 250 V, 4000 VA by AC1		
Contact separation:	galvanic, electrical strength 4 kV		
Mechanical life:	3x10 ⁷		
Electrical life:	0.7x10 ⁹		
Other information			
Operating position:	-10 °C to 55 °C (14 °F to 131 °F)		
Storing position:	-20 °C to 70 °C (-4 °F to 158 °F)		
Electical strenght:	4 kV		
Mounting:	wiring box with min. depth 30 mm / 1.18 ", Ø min. 65 mm / 2.6 "		
Protection degree:	IP30 in standard conditions*		
Max. cable size (mm ²):	solid wire 1x 2.5 / 1.5 with sleeve (AWG 12)		
Dimensions:	84 x 89 x 54.3 mm (3.3 " x 3.5 " x 2.14 ")		
Weight:	120 g (0.26 oz.)		
Standards:	EN 60730-2-9, EN 61812-1, EN 61010-1		

* see page 41

Design



Complete offer of switching devices line ELEGANT can be found in an individual catalogue ELEGANT Home switches, which can be sent to you upon request.

- DTR - Digital Thermo Room:**
 - Room thermostat with temperature range 5 to 50 °C (41 °F to 122 °F) with a built-in sensor.
- DTF - Digital Thermo Floor:**
 - Floor thermostat with temperature range 5 to 50 °C (41 °F to 122 °F) with external sensor.
- DTC - Digital Thermo Combined:**
 - Combined thermostat with room and floor sensors and temperature range 5 to 50 °C (41 °F to 122 °F).
 - Choice of temperature display from internal or external sensors.
 - By program it is possible to choose, which sensor is active and if it should function in serial or in parallel.
- DTF, DTC**
 - External sensor (TC-3, 3m) is a part of delivery (only ATF/ATC), it is possible to extend its length up to 100 m (328').
 - Monitoring of disconnection or short-circuit of external sensor, fault is displayed.

Description

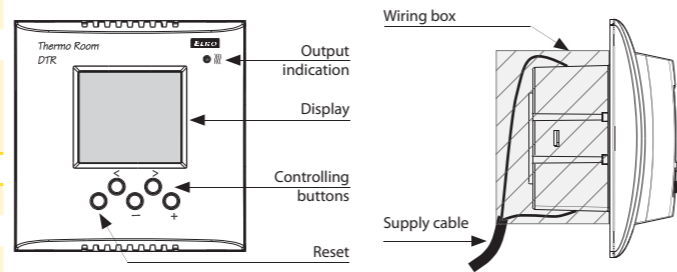

Description of visual elements on the display

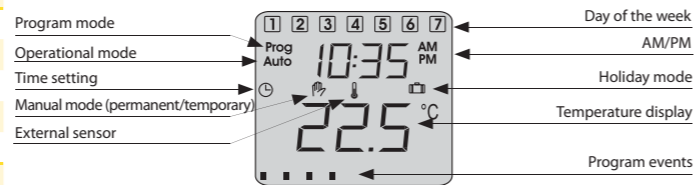

Other functions of DTR, DTF, DTC

- rechargeable backup battery in case of power failure (e.g. the high tariff of electric heating)
- push-button lock to prevent unwanted manipulation with thermostat
- the possibility of display settings - current or set temperature
- „freezing protection“ in case temperature drops below 5 °C (41 °F) thermostat always switches heating on
- choice of function heating or cooling
- easy and intuitive control by four push-buttons
- automatic shift summer / winter time
- holiday mode - it is possible to set temperature and time from 1 hour to 99 days without any intervention into program settings or turning heating off (suitable in case of planned absence holiday...)
- wall switch buttons in ELEGANT design, wide variety of colors and combination of multiframes

Connection

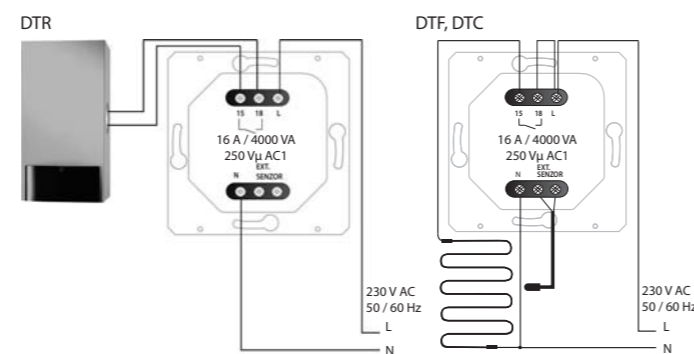

EAN code: 8595188160889
 ATV-1: 8595188160889
 USB programming adapter: 8595188160995

Technical parameters	ATV-1
Operating voltage:	3 V / DC (2 AA batteries 1.5 V / DC AA)
Temperature range:	8 to 28 °C (46 to 82 °F)
Color:	white
Dimensions (L x W x H):	76.5 x 53.5 x 63 mm (3" x 2.1" x 2.4")
Design:	thermostatic direction valves, electronic

Examples of daily heating program

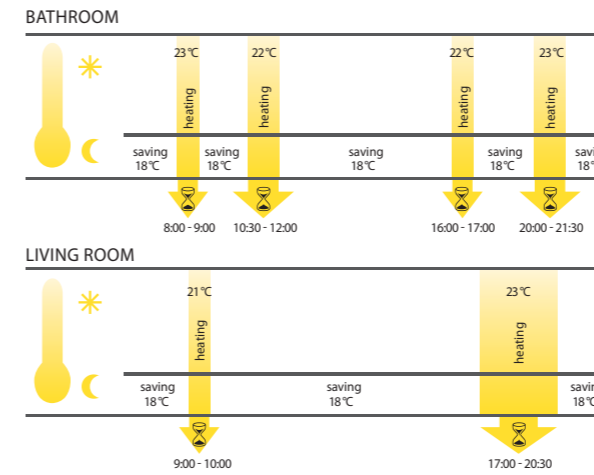

Adapters

Type of valve	Type of adapter
Heimeier, Junkers Landys+Gyr, MNG, Honeywell, Braukmann thread size M 30x1.5	No adapter necessary + enclosed pin; only for RAV
Danfoss RAV (the valve plunger must be fitted with the enclosed pin)	
Danfoss RA	
Danfoss RAVL	

- This energy-saving digital thermo-valve is a programmable regulation device for various heaters, but mainly radiators.
- It can be used to regulate temperature in closed rooms, thus helping to lower heat energy consumption.
- Functions:
 - Manual mode - measuring and checking a manually set temperature.
 - Automatic mode - control between two temperatures based on a set time program:
 - comfort temperature (factory settings 21 °C / 70 °F)
 - energy-saving temperature (factory settings 16 °C / 61 °F).
- Intervals of heating and energy-saving operation can be set using a freely adjustable time program.
 - 8 individually programmable switching times per day:
 - 4 heating intervals
 - 4 energy-saving intervals.
- The device features very quiet operation and long battery life (up to 5 years).
- Quick and easy installation.

Description of device

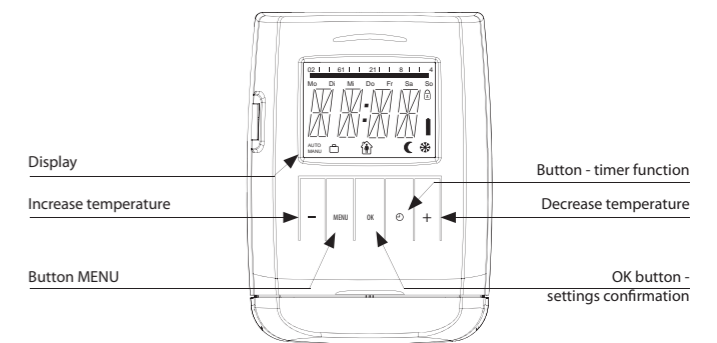

Other functions

1. Time function - the desired temperature can be set for a certain adjustable time interval.
2. Vacation function - while you're gone, you can set and maintain the desired temperature.
3. Open window function - when the temperature drops, the heating valve automatically closes in order to save energy.
4. Child safety block - blocking against undesired interference with the thermostat.
5. Freeze protection - if the temperature drops below 6 °C (43 °F), the valve opens until the temperature again exceeds 8 °C (46 °F). This keeps heaters from freezing.

Adjustment ATV-1

- manual
 - via USB programming adapter PROGmatic
- Using the programming port, in seconds your settings will be transferred into the thermostat.





- Two-level thermostat with function "WINDOW" meaning that output is switched in case the measured temperature is within set range (adjustable in range $-20..+20\text{ }^{\circ}\text{C}$ / $-4\text{ }^{\circ}\text{F}$ to $+68\text{ }^{\circ}\text{F}$).
- Used as protection against freezing (water-shoots, pavements, drives, pipes, etc.) heating is on when temperature falls under set upper level (e.g. $+5\text{ }^{\circ}\text{C}$ / $+41\text{ }^{\circ}\text{F}$) and off in case it falls under lower level (e.g. $-10\text{ }^{\circ}\text{C}$ / $-50\text{ }^{\circ}\text{F}$, when heating is not able effectively operate).
- Thermostat is placed in water-proof box with IP65, which allows installation outside, with in-built sensor TZ-0.
- Thermostat status is indicated by LED (3 colors) under transparent cover.
- Function monitoring short-circuit and sensor disconnection (break).
- Output changeover contact 16 A / SPDT (AC-1).

Description

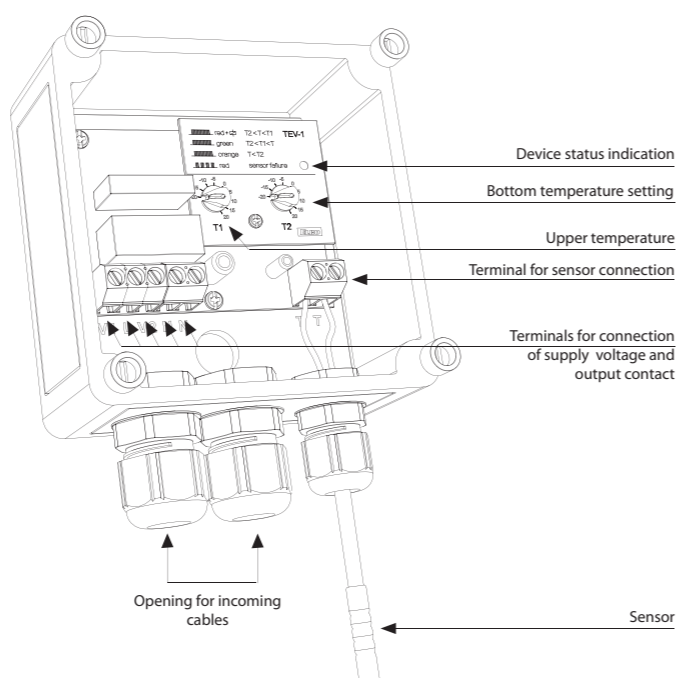

Function

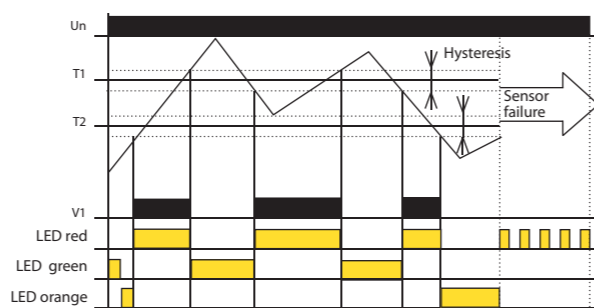

TEV-1 is a double thermostat designated for system of protection of roof water-shoots against freezing. The device is placed in a waterproof box (IP65), sensor with double insulation, which is a part of the device, senses ambient temperature. The device operates as zonal thermostat with independent setting of upper and bottom operational temperature. In case the ambient temperature is higher than T1 (upper temperature), thermostat switches heating of watershoots off (icing melts down). In case the ambient temperature is lower than T2 (bottom temperature), thermostat also switches heating off (to big freezing-heating cannot manage to melt the ice).

Symbol

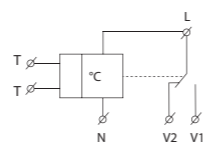

EAN code
TEV-1: 8595188129121

Technical parameters		TEV-1
Function:	two-level thermostat	
Supply terminals:	L - N	
Voltage range:	230 V AC / 50 - 60 Hz	
Input:	max. 2.5 VA / 0.5 W	
Max. dissipated power (Un + terminals):	3 W	
Tolerance of voltage range:	$\pm 15\%$	
Measuring circuit		
Measuring terminals:	T - T	
Temperature ranges		
thermostat 1:	-20 to $20\text{ }^{\circ}\text{C}$ ($-4\text{ }^{\circ}\text{F}$ to $68\text{ }^{\circ}\text{F}$)	
thermostat 2:	-20 to $20\text{ }^{\circ}\text{C}$ ($-4\text{ }^{\circ}\text{F}$ to $68\text{ }^{\circ}\text{F}$)	
Hysteresis (sensitivity):	$3\text{ }^{\circ}\text{C}$ ($\pm 1.5\text{ }^{\circ}\text{C}$) / $37.4\text{ }^{\circ}\text{F}$ ($\pm 34.7\text{ }^{\circ}\text{F}$)	
Sensor:	thermistor NTC 12 k Ω / $25\text{ }^{\circ}\text{C}$ ($77\text{ }^{\circ}\text{F}$)	
Faulty sensor indication:	red LED flashing	
Accuracy		
Accuracy of settings (mech.):	5 %	
Dependence on temperature:	$< 0.1\%$ / $^{\circ}\text{C}$ ($^{\circ}\text{F}$)	
Output		
Number of contacts:	1x changeover / SPDT (AgNi / Silver Alloy)	
Current rating:	16 A / AC1	
Max. breaking capacity:	4000 VA / AC1, 384 W / DC	
Peak current:	30 A / $< 3\text{ s}$	
Switched voltage:	250 V AC1	
Output indication:	LED	
Mechanical life:	3×10^7	
Electrical life:	0.7×10^6	
Other information		
Operation temperature:	$-30\text{ }^{\circ}\text{C}$ to $50\text{ }^{\circ}\text{C}$ ($-22\text{ }^{\circ}\text{F}$ to $140\text{ }^{\circ}\text{F}$)	
Operation position:	any	
Protection degree:	IP65	
Overvoltage category:	III.	
Pollution level:	2	
Max. cable size (mm ²):	solid wire 2.5 / with sleeve 1.5 (AWG 12)	
Dimensions:	110 x 135 x 66 mm (4.33" x 5.3" x 6.6")	
Weight:	270 g (9.5 oz.)	
Standards:	EN 60730-2-9, EN 61010-1	

Connection

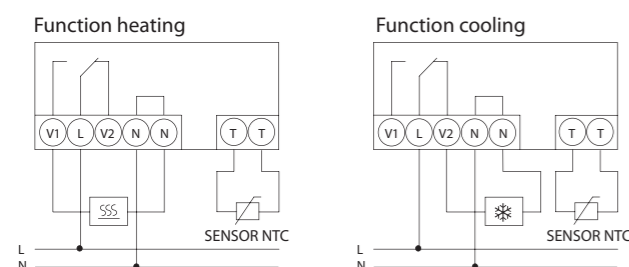

EAN code
TEV-2: 8595188129251
TEV-3: 8595188129268

Technical parameters		TEV-2	TEV-3
Function:	one-level thermostat		
Supply terminals:	L - N		
Voltage range:	230 V AC / 50 - 60 Hz		
Input:	max. 2.5 VA / 0.5 W		
Max. dissipated power:	3 W (Un + terminals)		
Tolerance of voltage range:	$\pm 15\%$		
Measuring circuit			
Measuring terminals:	T - T		
Temperature ranges:	-20 to $20\text{ }^{\circ}\text{C}$ (-4 to $68\text{ }^{\circ}\text{F}$)		5 to $35\text{ }^{\circ}\text{C}$ (41 to $95\text{ }^{\circ}\text{F}$)
Hysteresis (sensitivity):	$3\text{ }^{\circ}\text{C}$ ($\pm 1.5\text{ }^{\circ}\text{C}$) / $37.4\text{ }^{\circ}\text{F}$ ($\pm 34.7\text{ }^{\circ}\text{F}$)		
Sensor:	thermistor NTC 12 k Ω		
Faulty sensor indication:	red LED flashing		
Accuracy			
Accuracy of settings (mech.):	5 %		
Dependence on temperature:	$< 0.1\%$ / $^{\circ}\text{C}$ ($^{\circ}\text{F}$)		
Output			
Number of contacts:	1x changeover / SPDT (AgNi / Silver Alloy)		
Current rating:	16 A / AC1		
Max. breaking capacity:	4000 VA / AC1, 384 W / DC		
Peak current:	30 A / $< 3\text{ s}$		
Switched voltage:	250 V AC1		
Output indication:	red LED		
Mechanical life:	3×10^7		
Electrical life (AC1):	0.7×10^6		
Other information			
Operation temperature:	-30 to $50\text{ }^{\circ}\text{C}$ ($-22\text{ }^{\circ}\text{F}$ to $122\text{ }^{\circ}\text{F}$)		
Operation position:	any		
Protection degree:	IP65		
Overvoltage category:	III.		
Pollution level:	2		
Max. cable size (mm ²):	solid wire 2.5 / with sleeve 1.5 (AWG 12)		
Dimensions:	110 x 135 x 66 mm (4.33" x 5.3" x 2.3")		
Weight:	270 g (9.5 oz.)		274 g (9.7 oz.)
Standards:	EN 60730-2-9, EN 61010-1		

Connection

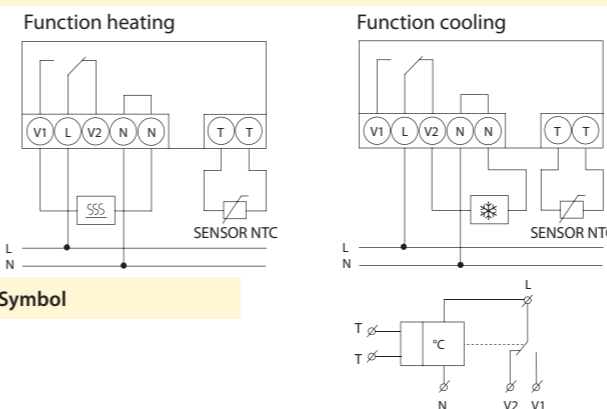

- Single thermostat with possibility of temperature management in adjustable range (it is possible to modify this range or make a special one on request).
- Used to regulate heating (or cooling) in demanding environments (outside, humidity, dustiness, etc.).
- Thermostat is placed in water-proof box with IP65 protection, which enables installation outside, with in-built sensor.
- **TEV-2:** control and indication elements are placed under transparent cover.
- **TEV-3:** control and indication elements are placed directly on the cover (for easy orientation and frequent change of temperature).
- Thermostat status is indicated by LED (2 colours).
- Function of monitoring sensor disconnection and short-circuit.
- Output 1x changeover / SPDT contact 16 A (AC-1).

Description TEV-2 (without cover)

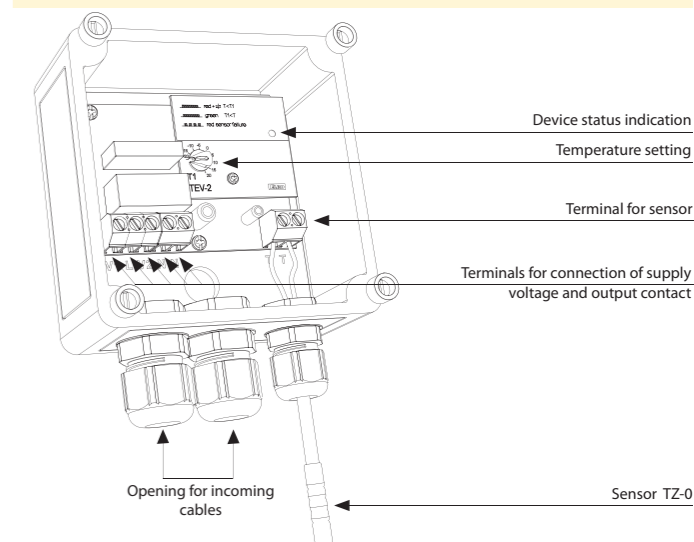

Description TEV-3 (cover)

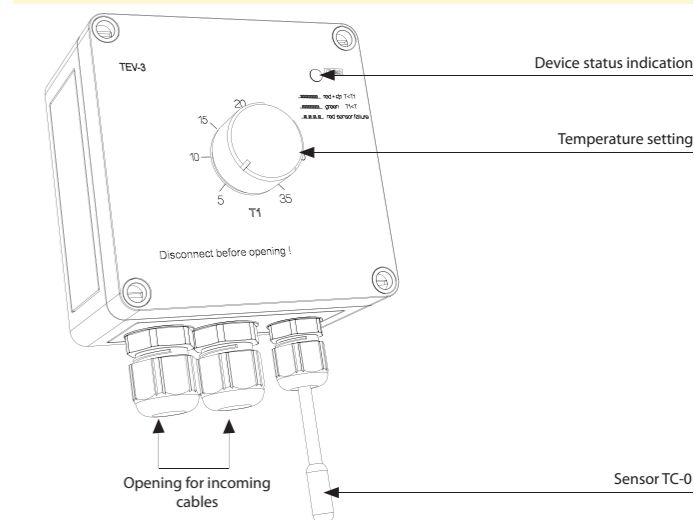

Function TEV-2, TEV-3

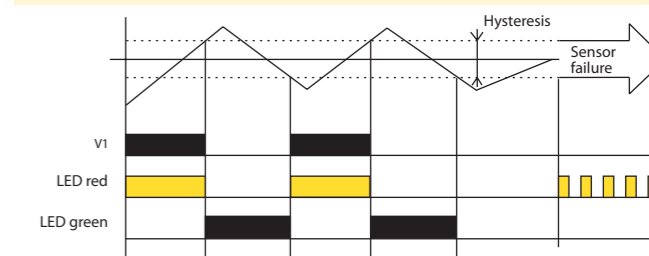

TEV-2 and TEV-3 are universal single thermostats for universal use. In case ambient temperature is higher than set temperature relay is open (function HEATING), for cooling function (opposite function) is possible to use NC contact of relay (V2).



- Single point thermostat for monitoring and regulation of temperature in demanding environments (humid and contaminated, aggressive and defective, industrial workshops, washing rooms, green-houses, cellars and cooling boxes...).
- External version in IP65, box for mounting on the wall.
- Built-in thermo-sensor is integrated in the device.
- Two functions adjustable by jumper: heating and cooling.
- 3 adjustable (by jumper) ranges of temperature, and fine adjustment through potentiometer.
- 3 adjustable (by jumper) levels of hysteresis.
- Supply voltage 230 V AC.
- Potentialless NO-SPST contact 12 A AC1 switching.

Description

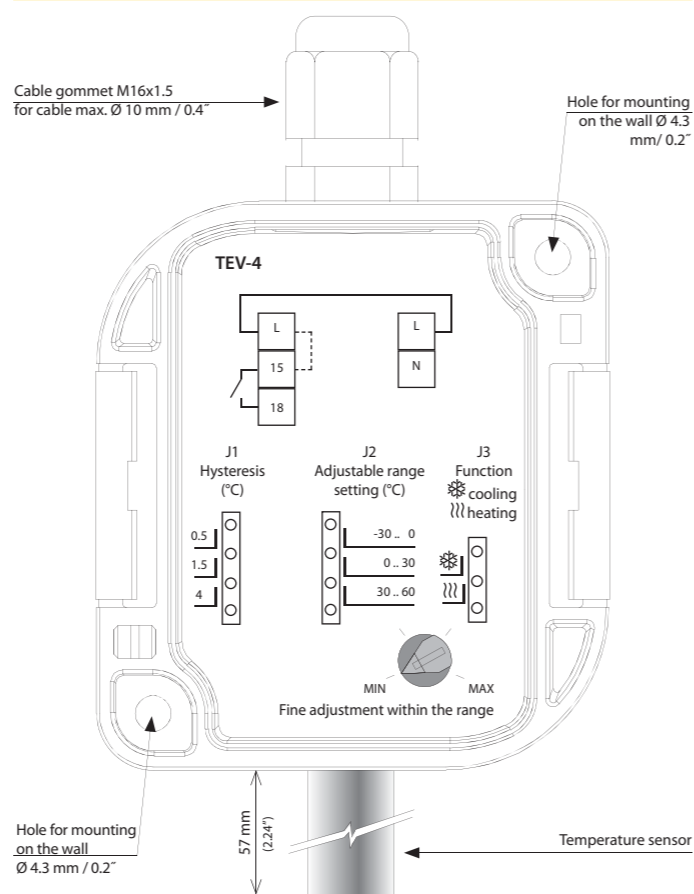

Connection

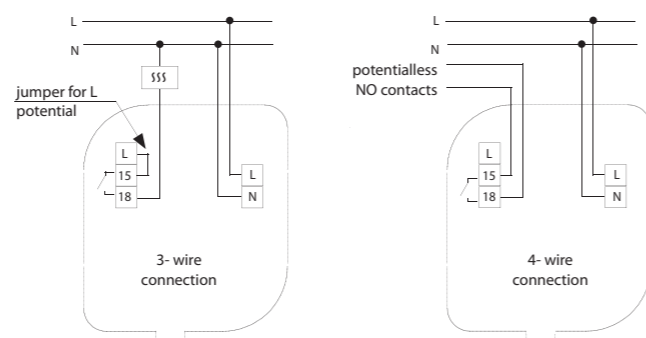

Description of function

Device is standardly supplied with jumper L-15 (3-wire connection). For the correct function of device is necessary sensor-side down device mounting.

EAN code
TEV-4: 8595188140577

Technical parameters

TEV-4

Supply

Supply terminals:	L - N
Voltage range:	AC 230V / 50 - 60Hz
Input (apparent / loss):	max. 6 VA / 0.7 W
Max. dissipated power (Un + terminals):	2.5 W
Tolerance of voltage range:	- 15 %.. +10 %

Function

setting by jumper J3

Function - ❄:	cooling
Function - 🔥:	heating

Temperature setting

by jumper J2

- range 1:	-30 °C to 0 °C (-22 °F to 32 °F)
- range 2:	0 °C to 30 °C (32 °F to 86 °F)
- range 3:	30 °C to 60 °C (86 °F to 140 °F)

Slight temperature setting:

potentiometer

Hysteresis

0.5 / 1.5 / 4 °C (32.9 / 34.7 / 39.2 °F)

Hysteresis setting:

by jumper J1

Output

Output contact:	1 x NO-SPST (AgSnO ₂)
Current rating:	12 A / AC1
Max. breaking capacity:	3000 VA / AC1, 384 W / DC
Peak current:	30 A / < 3 s
Switched voltage:	250 V AC / 24 V DC
Mechanical life:	3 x 10 ⁷
Electrical life:	0.7 x 10 ⁵

Other information

Operation temperature:	-30 °C to 65 °C (-22 °F to 149 °F)
Storing temperature:	-30 °C to 70 °C (-22 °F to 158 °F)
Electrical strength:	4kV (supply-output)
Operation position:	sensor-side down
Protection degree:	IP65
Overvoltage category:	III.
Pollution degree:	2
Max. cable size (mm ²):	max. 1x 2.5, max. 2x 1.5/ with sleeve max. 1x 2.5 (AWG 12)
Suggested power-supply cable:	CYKY 3x2.5 (CYKY 4x1.5)
Dimensions:	153 x 62 x 34 mm (6" x 2.4" x 1")
Weight:	123 g (4.3 oz.)
Standards:	EN 60730-2-9, EN 61010-1

Function

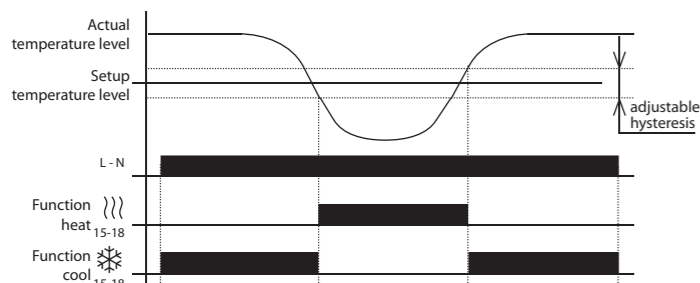

EAN code
RHT-1: 8595188137263

Technical parameters

RHT-1

Function:	hygro-thermostat
Supply terminals:	A1 - A2
Voltage range:	24 - 240 V AC/DC (AC 50 - 60 Hz)
Input:	max. 1 VA / 0.5 W
Max. dissipated power (Un + terminals):	2.5 W
Tolerance of voltage range:	-15 %; +10 %

Measuring circuit

Temperature range:	0 °C to 60 °C (32 °F to 140 °F)
Humidity range:	50..90 %
Temperature hysteresis:	2.5 °C (4.5 °F)
Humidity hysteresis:	4 %
Sensor:	internal
Indication of sensor's fault:	red LED flashing

Accuracy

Setting accuracy (mechanical):	5 %
Long-term stability of humidity:	typical < 0.8 % / year

Output

Number of contacts:	1x NO-SPST (AgSnO ₂)
Current rating:	16 A / AC1, 10 A / 24 V DC
Switched output:	4000 VA / AC1, 300 W / DC
Switched voltage:	250 V AC1 / 24 V DC
Output indication:	red LED shines
Mechanical life:	3x10 ⁷
Electrical life:	0.7x10 ⁵

Other information

Operational temperature:	-20 °C to 60 °C (-4 °F to 140 °F)
Storing temperature:	-30 °C to 70 °C (-22 °F to 158 °F)
Electrical strength:	2.5 kV (supply-output)
Operational position:	vertical, with correct orientation
Mounting:	DIN rail EN 60715
Protection degree:	IP40 from front panel, IP10 on terminals
Overvoltage category:	III.
Pollution degree:	2
Max. cable size (mm ²):	max. 2x 2.5, max. 1x 4 with sleeve max. 1x 2.5, max. 2x 1.5 (AWG 12)
Dimensions:	90 x 17.6 x 64 mm (3.5" x 0.7" x 2.5")
Weight:	63 g (2.2 oz.)
Standards:	EN 60730-2-9, EN 61010-1

- Hygro-thermostat for temperature monitoring and regulation in range 0 °C to 60 °C (32 °F to 140 °F) and relative humidity monitoring and regulation in range 50...90%.
- Possibility of setting of up to 8 conditions for contact switching and function permanently ON/OFF.
- Sensor is a part of the device - designated for measuring in switchboards.
- Function of sensor control (damage, disturbances...).
- Fixed setting of temperature hysteresis at 2.5 °C (4.5 °F) and humidity at 4%.
- Output state is indicated by red LED.
- Supply voltage AC/DC 24-240 V.
- Output contact 1x NO-SPST 16 A/250 V AC1.
- 1-MODULE, DIN rail mounting.

Device description

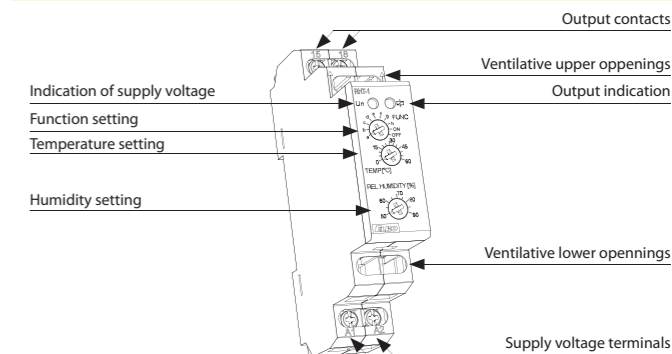

Funcions

Choice of function Relay switched under the following conditions

Choice of function	Relay switched under the following conditions
A	T > Tset or RH > RHset
B	T < Tset or RH > RHset
C	T > Tset or RH < RHset
D	T < Tset or RH < RHset
E	T < Tset and RH < RHset
F	T > Tset and RH < RHset
G	T < Tset and RH > RHset
H	T > Tset and RH > RHset
ON	relay permanently ON
OFF	relay permanently OFF

This device is designated for monitoring of parameters of environment (meaning temperature and relative humidity) in switchboards. It enables setting of eight conditions of contact closing and therefore it is usable for various types of load (e.g. fans, heating, air-conditioning, dehydrating units...).

While installing it is necessary to take into account the fact that hysteresis rises by persistence of measured values between sensor and ambient environment.

The device is equipped by sensor fault detection. In case of sensor fault, exceeding allowed limits (for temperature -30°C / -22 °F and +80°C/ 176 °F; for humidity 5% and 95%) or in case of faulty internal communication higher than 50% (due to e.g. high ambient disturbances) contact opens and sensor fault is indicated. Sensor fault doesn't have influence on function permanently ON or permanently OFF.

Note: In case the conditions for switching are not applied, relay is open.

Symbol

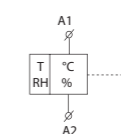

Connection





- Single hygrostat is used for regulation of humidity in harsh environments (washdown, greenhouse, refrigeration).
- External version in IP65, box for mounting on the wall.
- Built-in hygro-sensor is integrated in the device.
- Two functions adjustable by jumper: moistening and drying.
- 3 adjustable (by jumper) levels of hysteresis.
- Supply voltage 230V AC.
- NO contact closure 12A/AC1.

EAN code
RHV-1: 8595188140584

Technical parameters		RHV-1
Supply		
Supply terminals:	L - N	
Voltage range:	AC 230V / 50 - 60Hz	
Input (apparent/loss):	max. 6 VA / 0.7 W	
Max. dissipated power:	2.5 W (Un + terminals)	
Input voltage range:	- 15 % .. +10 %	
Setting function Setting function Jumper J3		
Function -	moistening	
Function -	drying	
Set. the scale of relative humidity Humidity setting Jumper J2		
- range 1:	0 ... 30 % RH	
- range 2:	30 ... 60 % RH	
- range 3:	60 ... 90 % RH	
Slight setting of relative humidity:	Relative Humidity Setting Potentiometer	
Hysteresis 2, 3, 4 % from setup rate		
Hysteresis setting:	Jumper J1	
Output		
Output contact:	1x NO-SPST (AgSnO ₂)	
Current rating:	12 A / AC1	
Switching output:	3000 VA / AC1, 384 W / DC	
Peak current:	30 A / < 3 s	
Switched voltage:	250 V AC / 24 V DC	
Mechanical life:	3 x 10 ⁷	
Electrical life:	0.7 x 10 ⁹	
Other information		
Operation temperature:	-30 °C to 60 °C (-22 °F to 140 °F)	
Storing temperature:	-30 °C to 70 °C (-22 °F to 158 °F)	
Electrical strength:	4kV (supply-output)	
Operation position:	sensor-side down	
Protection degree:	IP65	
Overvoltage category:	III.	
Pollution degree:	2	
Max. cable size (mm ²):	max. 1x 2.5, max. 2x 1.5 / with sleeve max. 1x 2.5 (AWG 12)	
Suggested power-supply cable:	CYKY 3x2.5 (CYKY 4x1.5)	
Dimensions:	153 x 62 x 34 mm (6" x 2.4" x 1.3")	
Weight:	124 g (4.4 oz.)	
Standards:	EN 60730-2-9, EN 61010-1	

Function

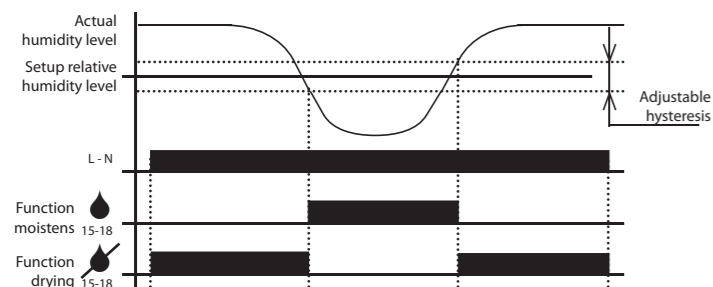

Description

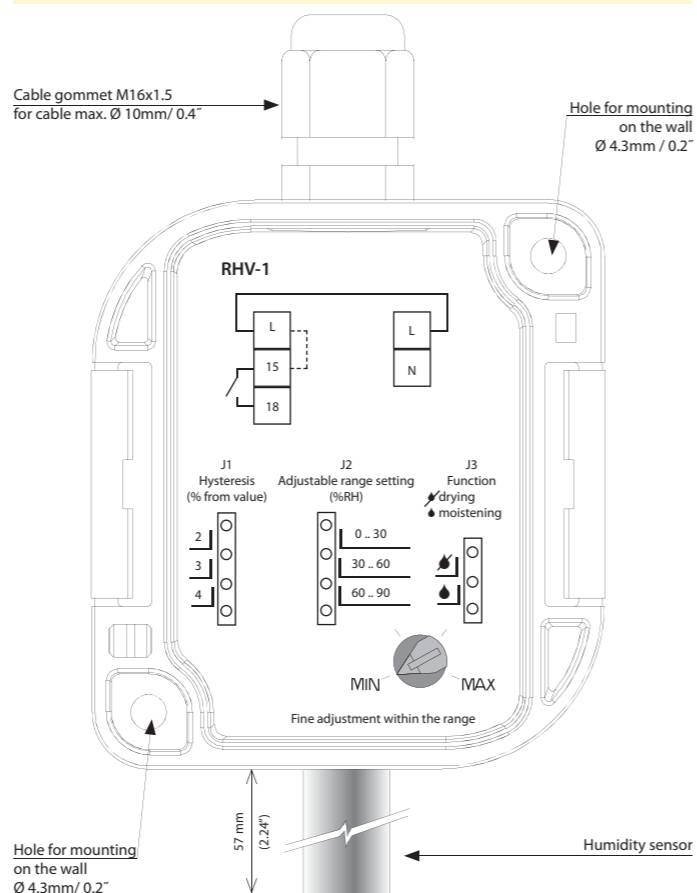

Connection

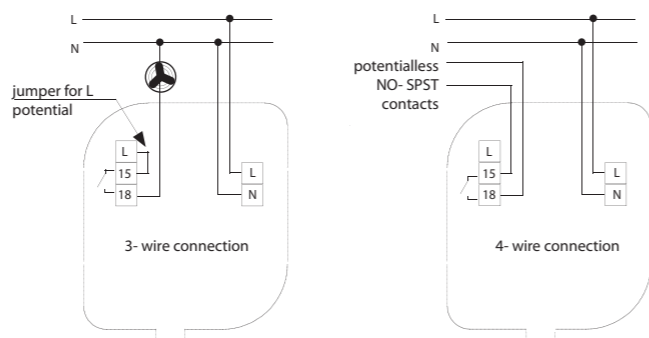

Description of function

Device is supplied with a standard jumper. For the device to operate correctly, it must be mounted with the sensor side down.

TC, TZ, Pt100 | Thermo sensors



EAN code	TC-0	TZ-0	Pt100-3	8595188136136	
TC-0:	8595188110075	TZ-0:	8595188140591	Pt100-3:	
TC-3:	8595188110617	TZ-3:	8595188110600	Pt100-6:	8595188136143
TC-6:	8595188110082	TZ-6:	8595188110594	Pt100-12:	8595188136150
TC-12:	8595188110099	TZ-12:	8595188110587		

Technical parameters	TC	TZ	Pt100
Range:	0 °C to +70 °C (32 °F to 158 °F)	-40 °C to +125 °C (-40 °F to 257 °F)	-30 °C to +200 °C (-22 °F to 392 °F)
Scanning element:	NTC 12K 5 %	NTC 12K 5 %	Pt100
In air / in water:	(τ65) 92 s / 23 s	(τ65) 62 s / 8 s	(τ0.5) - / 7 s
In air / in water:	(τ95) 306 s / 56 s	(τ95) 216 s / 23 s	(τ0.9) - / 19 s
Cable material:	High temperature PVC	Silicone	Silicone
Terminal material:	High temperature PVC	Nickel plated copper	Copper
Protection degree:	IP67	IP67	IP67
Insulation:	-	-	double insulation silicone

Types of temperature sensors

- length:	TC-0	TZ-0	-
- weight:	100 mm	110 mm	-
- length:	5 g	4.5 g	-
- weight:	TC-3	TZ-3	Pt100-3
- length:	3 m	3 m	3 m
- weight:	108 g	106 g	68 g
- length:	TC-6	TZ-6	Pt100-6
- weight:	6 m	6 m	6 m
- length:	213 g	216 g	149 g
- weight:	TC-12	TZ-12	Pt100-12
- length:	12 m	12 m	12 m
- weight:	466 g	418 g	249 g

τ65 (95): time, which sensor needs to heat up on 65 (95) % of ambient temperature of environment, in which is located.

- Thermister temperature sensors are made of Negative Temperature Coefficient (NTC) embedded in a PVC or metal sleeve with a thermally-conductive sealer.
- **Sensor TC**
 - lead-in cable to sensor TC is made of wire CYSY 2D x 0.5 mm / 0.02".
- **Sensor TZ**
 - cable VO3SS-F 2D x 0.5 mm / 0.02" with silicone insulation for use in high temperature applications.
 - silicone insulation for use in high temperature applications.
- **Sensor Pt100**
 - shielded silicon 2x 0.22 mm² (AWG 21), shielding connected with a case.
- Temperature sensors can be connected directly to the terminal block.
- Cable lengths can not be changed, connected or modified.

Resistive values of sensors in dependance on temperature

Temperature (°C/°F)	Sensor NTC (kΩ)	Sensor Pt100 (Ω)
20 / 68	14.7	107.8
30 / 86	9.8	111.7
40 / 104	6.6	115.5
50 / 122	4.6	119.4
60 / 140	3.2	123.2
70 / 158	2.3	127.1

Tolerance of sensor NTC 12 kΩ is ± 5% by 25 °C / 77°F. Long-term resistance stability by sensor Pt100 is 0.05% (10 000 hours).

Diagramm of sensor warm up via air

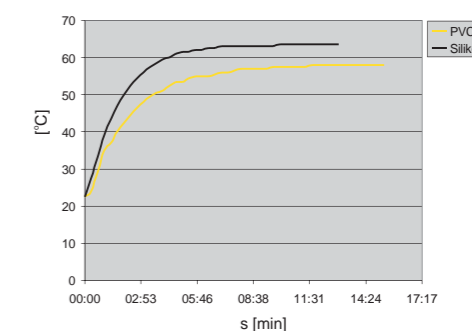

PVC - reaction to water temperature from 22.5 °C to 58 °C (from 72.5 °F to 136.4 °F).
Silicone - reaction to water temperature from 22.5 °C to 63.5 °C (from 72.5 °F to 144.5 °F).

TELVA 230V, TELVA 24V | Termodrive



EAN code
TELVA 230V, NC: 8595188166010
TELVA 230V, NO: 8595188166027
TELVA 24V, NC: 8595188166034
TELVA 24V, NO: 8595188166041

Technical parameters	TELVA 230V	TELVA 24V
Operating voltage:	230V, 50/60 Hz	24V, 50/60 Hz
Switching current max:	300 mA for max. 2 min	250 mA for max. 2 min
Operating current:	8 mA	75 mA
Closing / opening time:	cca 3 min.	cca 3 min.
Power input:	1.8 W	1.8 W
Protection:	IP 54/II	IP 54/II
Settings:	4 mm	4 mm
Stopping force:	100 N ±5 %	100 N ±5 %
Cable length:	1 m	1 m
Connecting wire:	2 x 0.75 mm ²	2 x 0.75 mm ²
Media temperature:	0.. +100 °C	0.. +100 °C
Color:	white RAL 9003	white RAL 9003
Dimensions h/w/d:	55+5 x 44 x 61 mm	55+5 x 44 x 61 mm

- The thermo-regulation drive TELVA is used to control underfloor and radiator hot-water heating.
- It is known for its quiet operation. It has a built-in valve position indicator.
- By mounting using the VA valve adapter, the thermo-regulation drive TELVA is applicable for a wide range of thermostatic valves available on the market.
- Design:
 - without voltage open (NO)
 - without voltage closed (NC)
- Types of thermo actuators:
 - TELVA 230V, NO
 - TELVA 230V, NC
 - TELVA 24V, NO
 - TELVA 24V, NC
- Type of use:
 - Underfloor heating - wireless controller RFTC-50/G measures the room temperature, and based on the set program, sends a command to the switching unit RFSA-66M to open / close the thermo-regulation drive TELVA at the distribution.

It is generally supplied with a valve adapter VA-80 in low design with bar M30 x 1.5 (white-gray), which may not be compatible with all types of valves.

Protection relays for industry

We come of monitoring relays that monitor machinery and manufacturing equipment. Enhanced types boast the ability to measure to approximately 2% accuracy, which distinguishes them from cheap competitors and increases the reliability. Experts will be pleased with the low power consumption of just 2.5 watts and the ability to monitor AC voltage and non-sinusoidal waveforms. They are suitable for 50 Hz and 60 Hz networks, which will be especially appreciated by customers whose products travel around the globe.

The powerful AT Mega 48P control processor enables the upgraded relay to modify the product parameters according to customer requirements (application request) without the need for hardware change.

For current relays, the accuracy of the current amplifier calibration current offset is increased. There are no connector connections inside the products, so they are mechanically very resistant to shocks. Also beneficial is the signalling LED, which alerts the operator to any delay.

In addition to a number of technical improvements, the relay also has a new, more modern design.

New range of monitoring relays covers control of:



Voltage relays



Current relays



Power factor relays



Frequency relays



Reverse power relays



Speed sensing

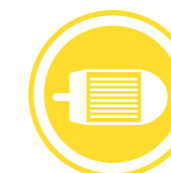

Synchro-check relays

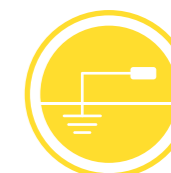

Ground fault relays

7 reasons, why you should chose monitoring relays from ELKO EP:

- 1 Brand new improved design.
- 2 Focus on industrial applications.
- 3 Bigger range of monitored current / voltage relays .
- 4 Increased measurement accuracy thanks to the newest components.
- 5 Suitable from 50 / 60 Hz networks.
- 6 Extended power supply 24-240V AC / DC.
- 7 Auxiliary power supply.

V Voltage

1 phase

AC



VROU1-28
These units monitor a single phase supply and operate relays if the phase voltage goes below or above set levels.



VRU1-28, VRO1-28
These units monitor a single phase supply and operate relays if the phase voltage goes below or above set levels.

DC



VRMV1-28
These units monitor a voltage of 50, 75 or 150 mV.

3 phase



VROU3-28
These units monitor a 3-phase 3-wire supply and operate relays if a phase-phase voltage goes below or above set levels.



VRU3-28
These units monitor a 3-phase 3-wire supply and operate relays if a phase-phase voltage goes below set levels.



VRO3-28
These units monitor a 3-phase 3-wire supply and operate relays if a phase-phase voltage goes below set levels.



VROU3N-28
These units monitor a 3-phase 4-wire supply and operate relays if a phase-neutral voltage goes below or above set levels.



VRU3N-28
These units monitor a 3-phase 4-wire supply and operate relays if a phase-neutral voltage goes below set levels.



VRO3N-28
These units monitor a 3-phase 4-wire supply and operate relays if a phase-neutral voltage goes below set levels.



VRSF3, VRSF3N
This unit monitors the voltage levels and phase sequence of a three-phase supply.



VRBU3, VRBU3N
This unit monitors a 3-phase supply for phase imbalance, low or missing phases or incorrect phase sequence.

A Current

AC



CROU1-28
These units monitor the AC current to a load and operate relays if the current goes below or above a set level.



CRU1-18, CRO1-18
These units monitor the AC current to a load and operate relays if the current goes below or above a set level.

DC



CRMA1-28
These units monitor a current of 0-1, 0-10 or 4-20 mA.

Synchro-check



VRSC1-28
This unit compares the voltage, frequency and phase angle of two supplies and operates a relay according to the synchronicity of the supplies.

Ground fault



CRGF1-18
Monitors the dangerous value of the leakage ground current that can cause

Reverse power



CRRP1-28, CRRP3-28
This unit monitors a single three-phase supply for reverse power and trips a relay if it detects reverse power ($I \times \cos \Phi$) over a set limit.

Speed sensing



FRSS1-38
This unit monitors the speed of rotating equipment using a magnetic pick-up and provides three relay outputs according to measured speeds.

Every type name has a logic explanation and lets you know everything you need to know to make a great choice:

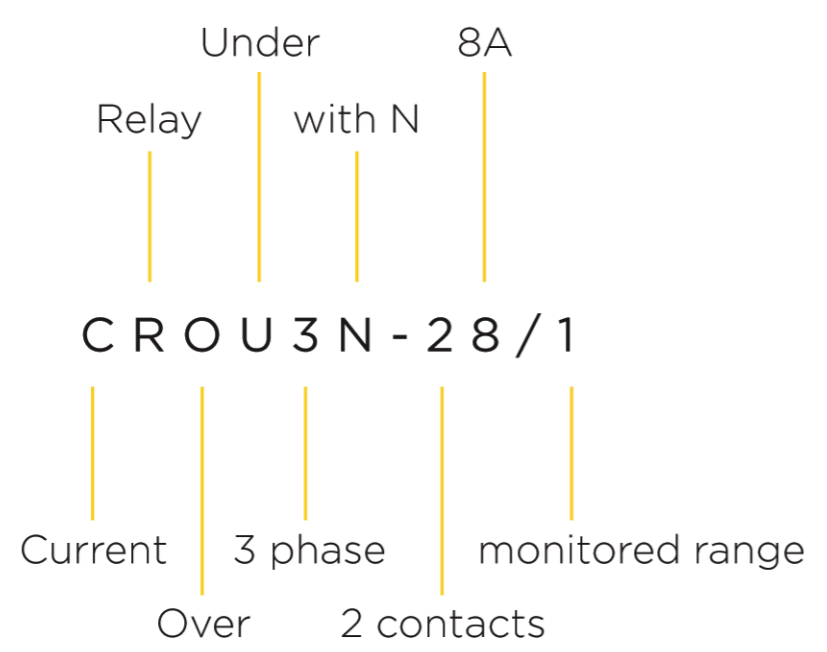
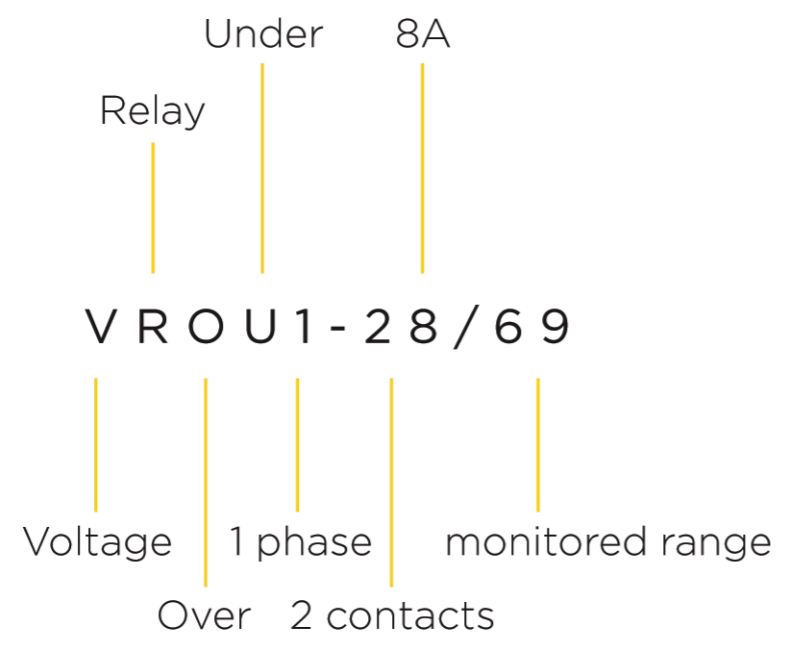

EAN code
 VROU1-28/69: 8595188155274
 VROU1-28/139: 8595188155281
 VROU1-28/277: 8595188155298

Technical parameters	VROU1-28/69	VROU1-28/139	VROU1-28/277
Nominal voltage range (Un):	57.7-69.3 V	100-139 V	220-277 V
		L-N	
Overload capacity			
- continuous:	87 V	174 V	346 V
- 10 s max:	104 V	209 V	416 V
Operating frequency:	45-65 Hz		
Auxiliary Supply Voltage:	24 V - 240 V AC/DC		
AC Supply frequency:	45-65 Hz		
Supply voltage tolerance:	±10%		
Auxiliary Voltage Burden (Max):	3 VA / 1.2 W		
Max. dissipated power (Un + terminals):	2.5 W		
Over-voltage range (Umax):	100-125 %Un		
Under-voltage range (Umin):	75-100 %Un		
Differential:	Adjustable 1-15 %Un		
Trip time delay:	Adjustable 0.5 to 10s		
Relay contacts:	2 x changeover, volt-free, for general switching operations		
Load capacity - AC:	250 V @ 8 A, 2 kVA		
Load capacity - DC:	30 V 8A		
Insulation:	4 kV/1 min		
Mechanical endurance:	30 x 10 ⁶ operations		
Other Data			
Operating temperature:	-20 to +55 °C		
Storage temperature:	-30 to +70 °C		
Over-voltage category:	III		
Pollution degree:	2		
Environmental protection:	IP40 for front panel, IP20 for terminals		
Maximum conductor size:	2 x 1.5 mm ² or 1 x 2.5 mm ²		
Dimensions:	90 x 52 x 64 mm		
Weight:	138 g		
Standards:	EN 60255-6, EN 60255-27, EN 61000-6-2, EN 61000-6-4		

Connection

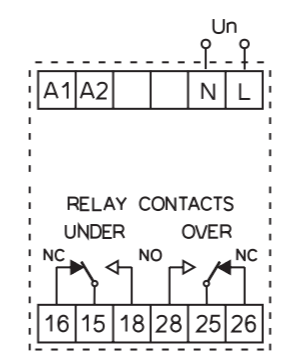

- These units monitor a single phase supply and operate relays if the phase voltage goes below or above set levels. Front panel controls allow selection of:
 - Under- and Over-voltage trip levels,
 - nominal rated voltage,
 - differential voltage for operating hysteresis and
 - time delay before a trip triggers a relay response.
- LEDs indicate power on and trip status. A relay with two changeover volt-free contacts is fitted.
- These instructions contain important safety information. Please read them thoroughly before commissioning, operating or maintenance of the unit.

Device description

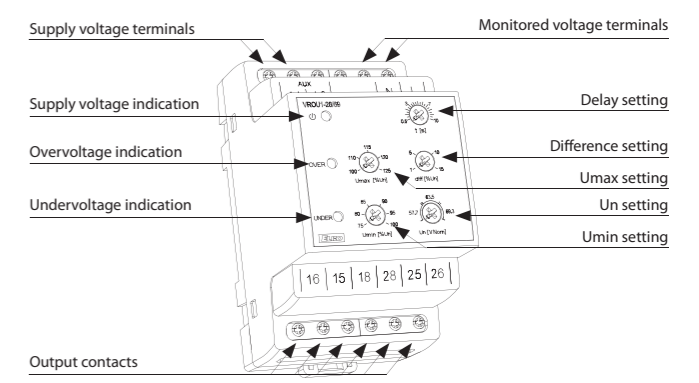

Function

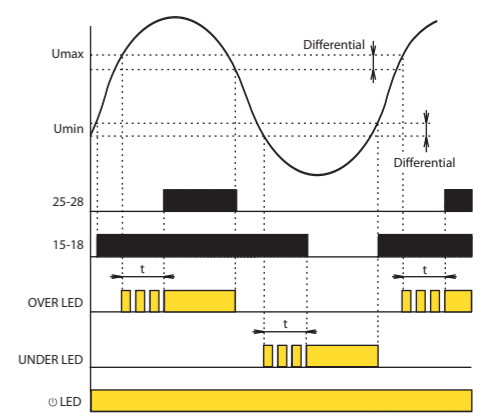

The time delay and differential trip levels help to prevent relay chatter as the monitored voltage level varies. As the relays have changeover contacts, the relay outputs can be inverted by wiring to the alternative terminals 15-16 or 25-26.

The unit obtains its power from the separate auxiliary supply. The green LED lights to show when this supply is present. Under normal conditions, with voltage at nominal level, both red LEDs will be off, the Under relay will be energised and the Over relay will be de-energised. With mains supply off, both relays will be de-energised.

Under-voltage Operation
 If the monitored phase voltage goes below the set under-voltage level (Umin), the Under LED will light and the Under relay (15-16/18) will de-energise after the set delay. During the delay period, the Under LED will flash.

If the voltage then returns above Umin plus the differential value, the Under LED will go off and the Under relay will energise again, without delay.

Over-voltage Operation
 If the monitored phase voltage goes above the set over-voltage level (Umax), the Over LED will light and the Over relay (25-26/28) will energise after the set delay. During the delay period, the Over LED will flash.

If the voltage then falls below Umax minus the differential value, the Over relay will de-energise and the Over LED will go off, without delay.

Note; Red LED indicates fault condition, not relay status.



EAN code
 VRU1-28/69: 8595188154437 VRO1-28/69: 8595188154406
 VRU1-28/139: 8595188154444 VRO1-28/139: 8595188154413
 VRU1-28/277: 8595188154451 VRO1-28/277: 8595188154420

Technical parameters	69	139	277
Nominal voltage range (Un):	57.7-69.3 V	100-139 V	220-277 V
Overload capacity	L-N		
- continuous:	87 V	174 V	346 V
- 10 s max:	104 V	209 V	416 V
Operating frequency:	45-65 Hz		
Auxiliary Supply Voltage:	24 V - 240 V AC/DC		
AC Supply frequency:	45-65 Hz		
Supply voltage tolerance:	±10%		
Auxiliary Voltage Burden (Max):	3 VA / 1.2 W		
Max. dissipated power (Un + terminals):	2.5 W		
Over-voltage range (Umax):	100-125 %Un (VRO1-28)		
Under-voltage range (Umin):	75-100 %Un (VRU1-28)		
Differential:	Adjustable 1-15 %Un		
Trip time delay:	Adjustable 0.5 to 10s		
Relay contacts:	2 x changeover, volt-free, for general switching operations		
Load capacity - AC:	250 V @ 8 A, 2 kVA		
Load capacity - DC:	30 V 8A		
Insulation:	4 kV/1 min		
Mechanical endurance:	30 x 10 ⁶ operations		
Other Data			
Operating temperature:	-20 to +55 °C		
Storage temperature:	-30 to +70 °C		
Over-voltage category:	III		
Pollution degree:	2		
Environmental protection:	IP40 for front panel, IP20 for terminals		
Maximum conductor size:	2 x 1.5 mm ² or 1 x 2.5 mm ²		
Dimensions:	90 x 52 x 64 mm		
Weight:	138 g		
Standards:	EN 60255-6, EN 60255-27, EN 61000-6-2, EN 61000-6-4		

Connection

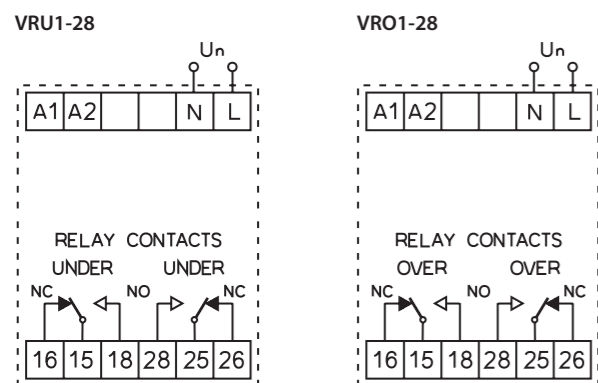

- These units monitor a single phase supply and operate relays if the phase voltage goes below or above set levels. Front panel controls allow selection of:
 - Under (VRU1-28)- and Over- (VRO1-28) voltage trip levels,
 - nominal rated voltage,
 - differential voltage for operating hysteresis and
 - time delay before a trip triggers a relay response.
- LEDs indicate power on and trip status. A relay with two changeover volt-free contacts is fitted.
- These instructions contain important safety information. Please read them thoroughly before commissioning, operation or maintenance of the unit.

Device description

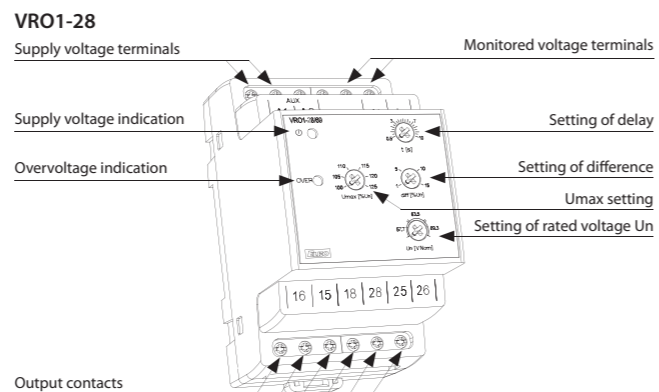
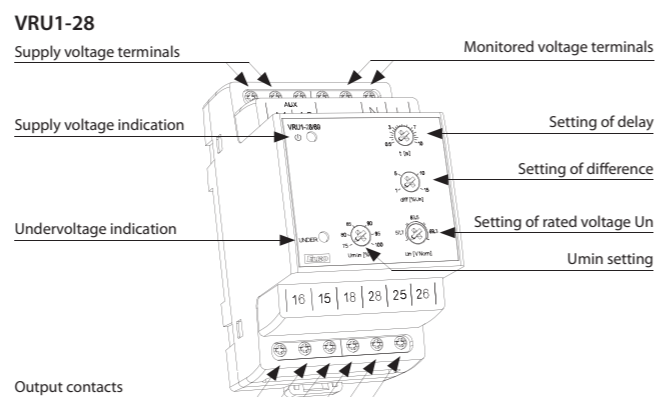

Function

VRU1-28

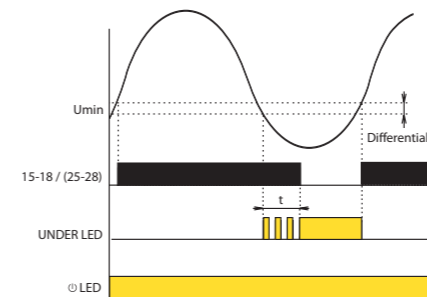

VRO1-28

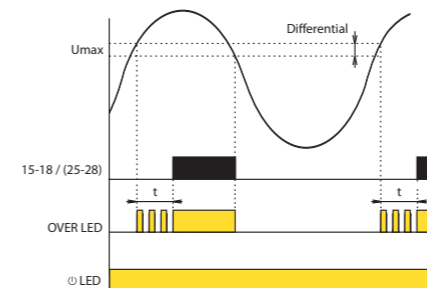

The time delay and differential trip levels help to prevent relay chatter as the monitored voltage level varies.

As the relays have changeover contacts, the relay outputs can be inverted by wiring to the alternative terminals 15-16 or 25-26.

The unit obtains its power from the separate auxiliary supply.

The green LED lights to shows when this supply is present.

Under-voltage Mode (Model VRU1-28)

If the monitored phase voltage goes below the set under-voltage level (Umin), the Under LED will light and relay (15-16/18) & (25-26/28) will deenergise after the set delay. During the delay period, the Under LED will flash. If the voltage then returns above Umin plus the differential value, the Under LED will go off and the Under relay will energise again, without delay.

Over-voltage Mode (Model VRO1-28)

If the monitored phase voltage goes above the set over-voltage level (Umax), the Over LED will light relay (15-16/18) & (25-26/28) will energise after the set delay. During the delay period, the Over LED will flash. If the voltage then falls below Umax minus the differential value, the Over relay will de-energise and the Over LED will go off, without delay.

Note; Red LED indicates fault condition, not relay status.



EAN code
VRSC1-28/69: 8595188142250
VRSC1-28/139: 8595188142267
VRSC1-28/277: 8595188142274

Technical parameters	VRSC1-28/69	VRSC1-28/139	VRSC1-28/277
Rated Vg range Un:	57-69 V	100-139 V	220-277 V
Overload capacity			
- continuous:	87 V	174 V	346 V
- 10s max.:	104 V	209 V	416 V
Minimum supply Vg Uopen:			
	35 V	60 V	132 V
Burden on supply (Max):	2 VA / 1.6W	2.7 VA / 1.7W	4 VA / 2.2W
Max. dissipated power (Un + terminals):	3 W	3 W	3.5 W
Frequency range:	45-65 Hz		
Deadbus on Udbon:	25% Un		
Deadbus off Udboff:	50% Un		
Sync Tolerance:	10-30% Volts		
Relay contacts:	2 x changeover, volt-free, for general switching operations		
Load capacity - AC:	250 V @ 8 A, 2 kVA		
Load capacity - DC:	30 V 8A		
Insulation:	4 kV/1 min		
Mechanical endurance:	30 x 10 ⁶ operations		
Other Data			
Operating temperature:	-20 to +55 °C		
Storage temperature:	-30 to +70 °C		
Over-voltage category:	III		
Pollution degree:	2		
Environmental protection:	IP40 for front panel, IP20 for terminals		
Maximum conductor size:	2 x 1.5 mm ² or 1 x 2.5 mm ²		
Dimensions:	90 x 105 x 64 mm		
Weight:	291 g	335 g	332 g
Standards:	EN 60255-6, EN 60255-27, EN 61000-6-2, EN 61000-6-4		

Connection

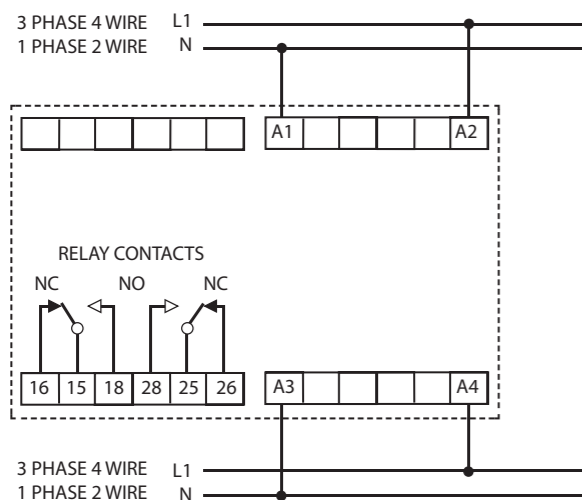

- This unit compares the voltage, frequency and phase angle of two supplies and operates a relay according to the synchronicity of the supplies. If the two supplies cease to match, the relay operates to provide a control output. The relay output can be used for alarm or control purposes.
- The unit also provides a dead bus function. If the bus supply fails, the relay operates and the output can be used to switch in an emergency generator. LEDs indicate power on, relay and dead bus status.
- Controls on the front panel set the trip points at which the relays and LEDs operate:
 - Degree of synchronicity Ux (%Volts)
 - Nominal voltage (Un)
 - Dead bus function on/off
- The unit is powered from the generator supply.
- These instructions contain important safety information. Please read them thoroughly before commissioning, operating or maintenance of the unit.

Device description

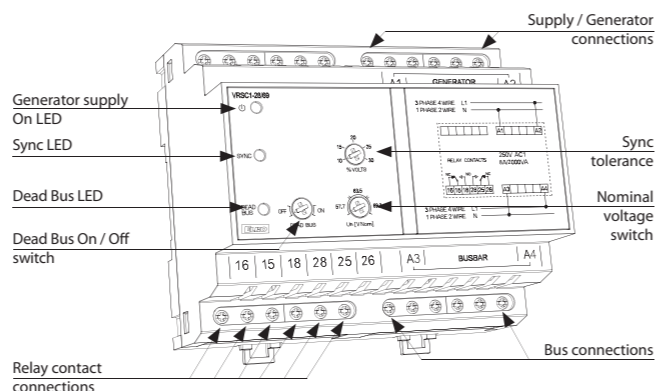

Function

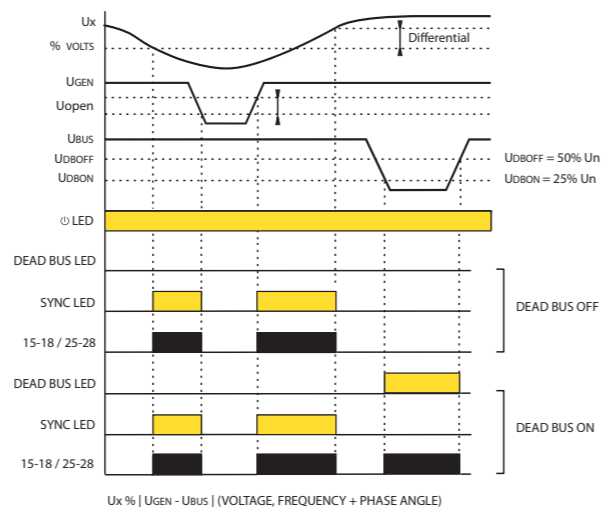

The differential trip levels help to prevent relay chatter as the monitored voltage level varies.

As the relays have changeover contacts, the relay outputs can be inverted by wiring to the alternative terminals 15-16 or 25-26.

The green LED lights shows when the power supply is on. While the two supplies match in voltage, frequency and phase to the degree set by the % Volts control, the Sync LED lights and the relay is energised. If one supply varies such that they no longer match to that degree, the Sync LED goes off and the relay de-energises.

If the generator voltage falls below the Uon level, the unit ceases to operate, the relay de-energises and the Sync LED goes off.

With Dead Bus On, if the bus voltage falls below the Udbon level, the relay energises and the Dead Bus LED lights. The relay can be used to turn on an emergency supply in the event of bus supply failure. The relay will de-energise again and the LED will go off when the bus voltage rises above the Udboff level.

Note; Red LED indicates fault condition, not relay status.



EAN code
VRMV1-28/240: 8595188145695
VRMV1-28/24: 8595188144872

Technical parameters	VRMV1-28/24	VRMV1-28/240
Supply voltage:	12-24V DC	24V-240V AC/DC
Burden on supply (Max):	1 W	3 VA / 0.9 W
Max. dissipated power (Un + terminals):	2 W	
AC Supply frequency:	45-65 Hz	
Supply voltage tolerance:	± 10 %	
Rated DC voltage Uin:	50 mV, 75 mV, 100 mV	
Input impedance:	50 kΩ	
Over-voltage range (Umax):	40-120 % Uin	
Under-voltage range (Umin):	0-80 % Uin	
Overload capacity:	10 x Uin	
Differential:	Fixed at 1% Uin	
Trip time delay:	Adjustable 0.5 to 10s	
Relay contacts:	2 x changeover, volt-free, for general switching operations	
Load capacity - AC:	250 V @ 8 A, 2 kVA	
Load capacity - DC:	30 V 8A	
Insulation:	4 kV/1 min	
Mechanical endurance:	30 x 10 ⁶ operations	
Other Data		
Operating temperature:	-20 to +55 °C	
Storage temperature:	-30 to +70 °C	
Over-voltage category:	III	
Pollution degree:	2	
Environmental protection:	IP40 for front panel, IP20 for terminals	
Maximum conductor size:	2 x 1.5 mm ² or 1 x 2.5 mm ²	
Dimensions:	90 x 52 x 64 mm	
Weight:	135 g	
Standards:	EN 60255-6, EN 60255-27, EN 61000-6-2, EN 61000-6-4	

Connection

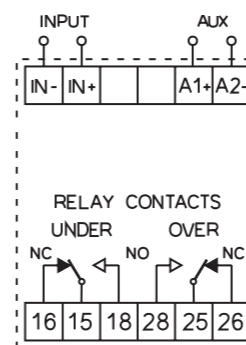

- These units monitor a voltage of 50, 75 or 150 mV, e.g. from a standard current shunt, and operates one of two relays if the voltage goes above or below set levels. Front panel controls allow selection of:
 - under- and over-voltage trip levels Umax, Umin
 - nominal rated voltage of 50, 75 or 100 mV (Uin)
 - time delay before a trip triggers a relay response.
- LEDs indicate power on and trip status. Two changeover, volt-free relays are fitted.
- Two types are available - a 12-24 unit powered from 12-24V DC and a 24-240 unit powered from 24V-240V AC or DC
- These instructions contain important safety information. Please read them thoroughly before commissioning, operating or maintenance of the unit.

Device description

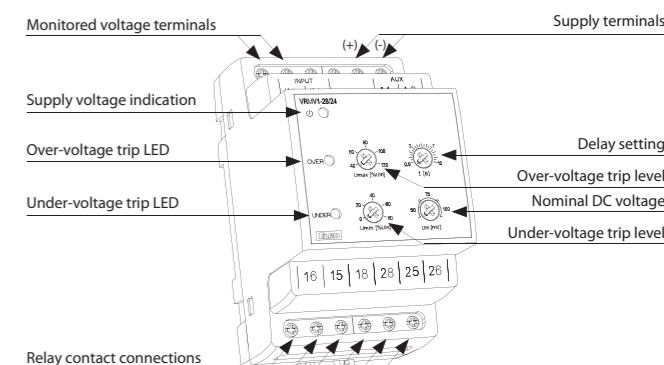

Function

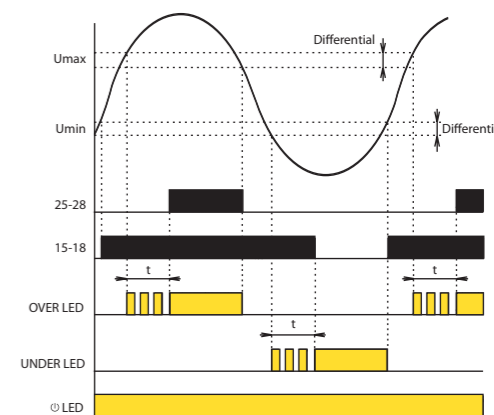

The time delay and differential trip levels help to prevent relay chatter as the monitored voltage level varies.

As the relays have changeover contacts, the relay outputs can be inverted by wiring to the alternative terminals 15-16 or 25-26.

The green LED lights to shows when the supply is present.

Under normal conditions, with the monitored voltage at nominal levels, both red LEDs will be off, the Under relay will be energised and the Over relay will be de-energised. With supply voltage off, both relays will be de-energised.

Under-voltage Operation

If the monitored voltage goes below the set under-voltage level (Umin), the Under LED will light and the Under relay (15-16/18) will de-energise after the set delay. During the delay period, the Under LED will flash.

If the voltage then returns above Umin plus the differential value, the Under LED will go off and the Under relay will energise again, without delay.

Over-voltage Operation

If the monitored voltage goes above the set over-voltage level (Umax), the Over LED will light and the Over relay (25-26/28) will energise after the set delay. During the delay period, the Over LED will flash.

If the voltage then falls below Umax minus the differential value, the Over relay will de-energise and the Over LED will go off, without delay.

Note; Red LED indicates fault condition, not relay status.



EAN code
 VROU3-28/120: 8595188155304
 VROU3-28/240: 8595188155311
 VROU3-28/480: 8595188155328

Technical parameters	VROU3-28/120	VROU3-28/240	VROU3-28/480
Nominal voltage range (Un):	100-120 V	173-240 V	380-480 V
Overload capacity			
- continuous:	160 V	312 V	624 V
- 10 s max:	180 V	360 V	720 V
Operating frequency:	45-65 Hz		
Auxiliary Supply Voltage:	24 V - 240 V AC/DC		
AC Supply frequency:	45-65 Hz		
Supply voltage tolerance:	±10%		
Auxiliary Voltage Burden (Max):	3 VA / 1.2 W		
Max. dissipated power (Un + terminals):	2.5 W		
Over-voltage range (Umax):	100-125 %Un		
Under-voltage range (Umin):	75-100 %Un		
Differential:	Adjustable 1-15 %Un		
Trip time delay:	Adjustable 0.5 to 10s		
Relay contacts:	2 x changeover, volt-free, for general switching operations		
Load capacity - AC:	250 V @ 8 A, 2 kVA		
Load capacity - DC:	30 V 8A		
Insulation:	4 kV/1 min		
Mechanical endurance:	30 x 10 ⁶ operations		
Other Data			
Operating temperature:	-20 to +55 °C		
Storage temperature:	-30 to +70 °C		
Over-voltage category:	III		
Pollution degree:	2		
Environmental protection:	IP40 for front panel, IP20 for terminals		
Maximum conductor size:	2 x 1.5 mm ² or 1 x 2.5 mm ²		
Dimensions:	90 x 52 x 64 mm		
Weight:	138 g		
Standards:	EN 60255-6, EN 60255-27, EN 61000-6-2, EN 61000-6-4		

Connection

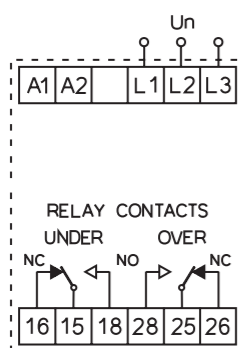

- These units monitor a 3-phase 3-wire supply and operate relays if a phase-phase voltage goes below or above set levels. Front panel controls allow selection of:
 - Under- and Over-voltage trip levels,
 - nominal rated voltage,
 - differential voltage for operating hysteresis and
 - time delay before a trip triggers a relay response.
- LEDs indicate power on and trip status. A relay with two changeover volt-free contacts is fitted.
- These instructions contain important safety information. Please read them thoroughly before commissioning, operation or maintenance of the unit.

Device description

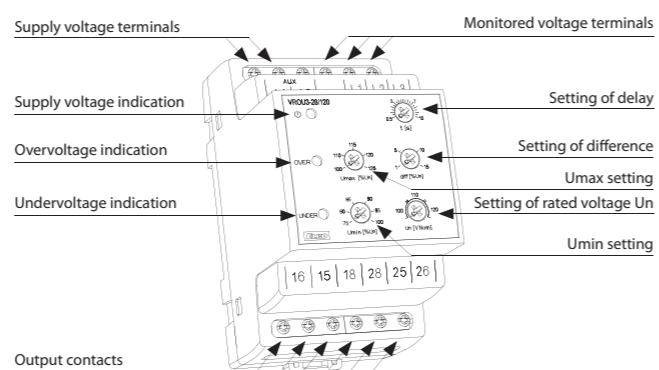

Function

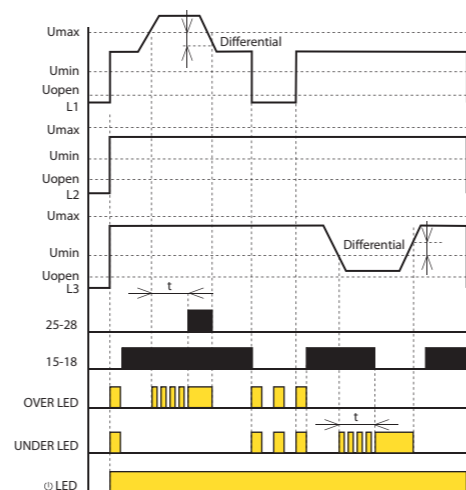

The time delay and differential trip levels help to prevent relay chatter as the monitored voltage level varies. As the relays have changeover contacts, the relay outputs can be inverted by wiring to the alternative terminals 15-16 or 25-26. The unit obtains its power from the separate auxiliary supply. The green LED lights to shows when this supply is present. Under normal conditions, with all three phases at nominal level, both red LEDs will be off, the Under relay will be energised and the Over relay will be de-energised. With mains supply off, both relays will be de-energised.

Under-voltage Mode
 If the monitored voltage of any phase goes below the set under-voltage level (Umin), the Under LED will light and the Under relay (15-16/18) will de-energise after the set delay. During the delay period, the Under LED will flash. If the voltage then returns above Umin plus the differential value, the Under LED will go off and the Under relay will energise again, without delay.

Over-voltage Mode
 If the monitored voltage of any phase goes above the set over-voltage level (Umax), the Over LED will light and the Over relay (25-26/28) will energise after the set delay. During the delay period, the Over LED will flash. If the voltage then falls below Umax minus the differential value, the Over relay will de-energise and the Over LED will go off, without delay. Note; Red LED indicates fault condition, not relay status.



EAN code
 VRU3-28/120: 8595188154376
 VRU3-28/240: 8595188154383
 VRU3-28/480: 8595188154390

Technical parameters	VRU3-28/120	VRU3-28/240	VRU3-28/480
Nominal voltage range (Un):	100-120 V	173-240 V	380-480 V
Overload capacity		L-L	
- continuous:	150 V	300 V	600 V
- 10 s max:	180 V	360 V	720 V
Operating frequency:	45-65 Hz		
Auxiliary Supply Voltage:	24 V - 240 V AC/DC		
AC Supply frequency:	45-65 Hz		
Supply voltage tolerance:	±10%		
Auxiliary Voltage Burden (Max):	3 VA / 1.2 W		
Max. dissipated power (Un + terminals):	2.5 W		
Under-voltage range (Umin):	75-100 %Un		
Differential:	Adjustable 1-15 %Un		
Trip time delay:	Adjustable 0.5 to 10s		
Relay contacts:	2 x changeover, volt-free, for general switching operations		
Load capacity - AC:	250 V @ 8 A, 2 kVA		
Load capacity - DC:	30 V 8A		
Insulation:	4 kV/1 min		
Mechanical endurance:	30 x 10 ⁶ operations		
Other Data			
Operating temperature:	-20 to +55 °C		
Storage temperature:	-30 to +70 °C		
Over-voltage category:	III		
Pollution degree:	2		
Environmental protection:	IP40 for front panel, IP20 for terminals		
Maximum conductor size:	2 x 1.5 mm ² or 1 x 2.5 mm ²		
Dimensions:	90 x 52 x 64 mm		
Weight:	138 g		
Standards:	EN 60255-6, EN 60255-27, EN 61000-6-2, EN 61000-6-4		

Connection

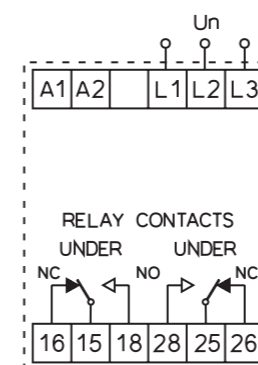

- These units monitor a 3-phase 3-wire supply and operate relays if a phase-phase voltage goes below set levels. Front panel controls allow selection of:
 - Under voltage trip levels,
 - nominal rated voltage,
 - differential voltage for operating hysteresis and
 - time delay before a trip triggers a relay response.
- LEDs indicate power on and trip status. A relay with two changeover volt-free contacts is fitted.
- These instructions contain important safety information. Please read them thoroughly before commissioning, operation or maintenance of the unit.

Device description

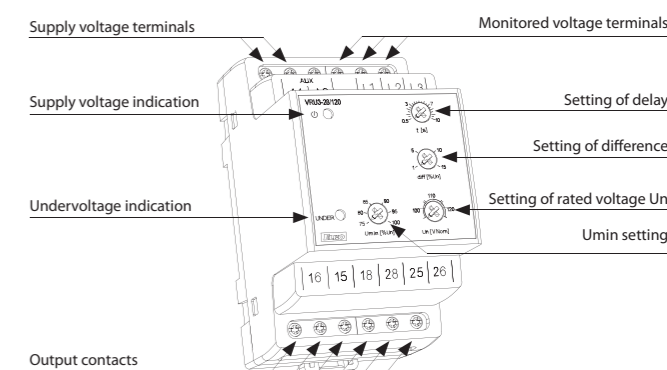

Function

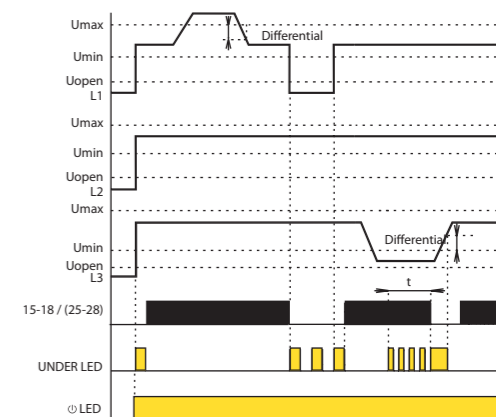

The time delay and differential trip levels help to prevent relay chatter as the monitored voltage level varies. As the relays have changeover contacts, the relay outputs can be inverted by wiring to the alternative terminals 15-16 or 25-26. The unit obtains its power from the separate auxiliary supply. The green LED lights to shows when this supply is present. Under normal conditions, with all three voltages at nominal level, the red LED will be off, the Under relay will be energised. With mains supply off the relay will be de-energised.

Under-voltage Operation
 If the monitored voltage of any phase goes below the set under-voltage level (Umin), the Under LED will light and the Under relay (15-16/18) & (25-26/28) will de-energise after the set delay. During the delay period, the Under LED will flash. If the voltage then returns above Umin plus the differential value, the Under LED will go off and the Under relay will energise again, without delay. Note; Red LED indicates fault condition, not relay status.



EAN code
VRO3-28/120: 8595188155243
VRO3-28/240: 8595188155250
VRO3-28/480: 8595188155267

Technical parameters	VRO3-28/120	VRO3-28/240	VRO3-28/480
Nominal voltage range (Un):	100-120 V	173-240 V	380-480 V
Overload capacity	L-L		
- continuous:	150 V	300 V	600 V
- 10 s max:	180 V	360 V	720 V
Operating frequency:	45-65 Hz		
Auxiliary Supply Voltage:	24 V - 240 V AC/DC		
AC Supply frequency:	45-65 Hz		
Supply voltage tolerance:	±10%		
Auxiliary Voltage Burden (Max):	3 VA / 1.2 W		
Max. dissipated power (Un + terminals):	2.5 W		
Over-voltage range (Umax):	100-125 %Un		
Differential:	Adjustable 1-15 %Un		
Trip time delay:	Adjustable 0.5 to 10s		
Relay contacts:	2 x changeover, volt-free, for general switching operations		
Load capacity - AC:	250 V @ 8 A, 2 kVA		
Load capacity - DC:	30 V 8A		
Insulation:	4 kV/1 min		
Mechanical endurance:	30 x 10 ⁶ operations		
Other Data			
Operating temperature:	-20 to +55 °C		
Storage temperature:	-30 to +70 °C		
Over-voltage category:	III		
Pollution degree:	2		
Environmental protection:	IP40 for front panel, IP20 for terminals		
Maximum conductor size:	2 x 1.5 mm ² or 1 x 2.5 mm ²		
Dimensions:	90 x 52 x 64 mm		
Weight:	138 g		
Standards:	EN 60255-6, EN 60255-27, EN 61000-6-2, EN 61000-6-4		

Connection

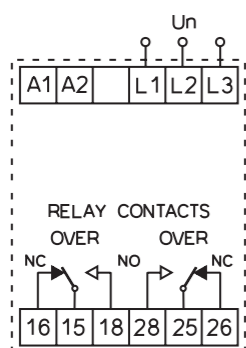

- These units monitor a 3-phase 3-wire supply and operate relays if a phase-phase voltage goes below set levels. Front panel controls allow selection of:
 - Over voltage trip levels,
 - nominal rated voltage,
 - differential voltage for operating hysteresis and
 - time delay before a trip triggers a relay response.
- LEDs indicate power on and trip status. A relay with two changeover volt-free contacts is fitted.
- These instructions contain important safety information. Please read them thoroughly before commissioning, operation or maintenance of the unit.

Device description

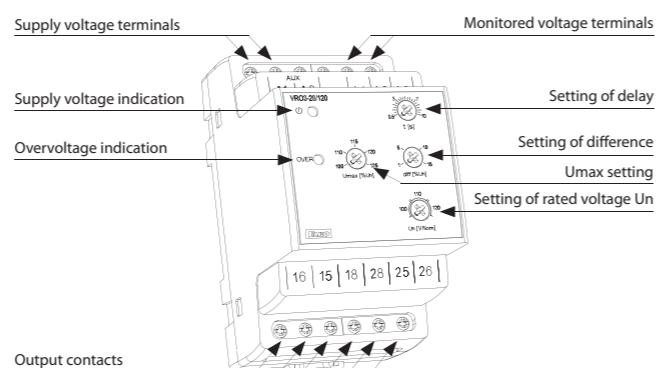

Function

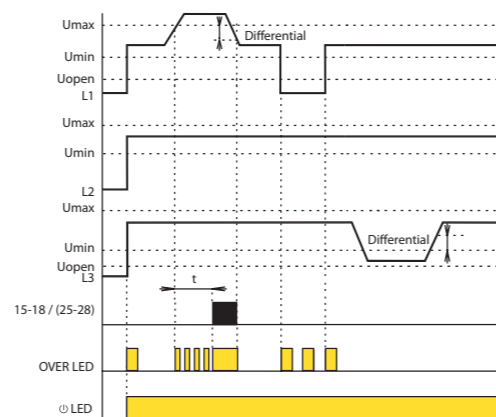

The time delay and differential trip levels help to prevent relay chatter as the monitored voltage level varies. As the relays have changeover contacts, the relay outputs can be inverted by wiring to the alternative terminals 15-16 or 25-26.

The unit obtains its power from the separate auxiliary supply. The green LED lights to shows when this supply is present. Over normal conditions, with all three voltages at nominal level, the red LED will be off, the Over relay will be de-energised. With mains supply off the relay will be de-energised.

Over-voltage Mode
If the monitored voltage of any phase goes above the set over-voltage level (Umax), the Over LED will light and the Over relay (15-16/18) & (25-26/28) will energise after the set delay. During the delay period, the Over LED will flash.

If the voltage then falls below Umax minus the differential value, the Over relay will de-energise and the Over LED will go off, without delay.

Note; Red LED indicates fault condition, not relay status.



EAN code
VROU3N-28/120: 8595188154345
VROU3N-28/240: 8595188154352
VROU3N-28/480: 8595188154369

Technical parameters	VROU3N-28/120	VROU3N-28/240	VROU3N-28/480
Nominal voltage range (Un):	57.7-69.3 V	100-139 V	220-277 V
Overload capacity	L-N		
- continuous:	90 V	181 V	360 V
- 10 s max:	104 V	209 V	416 V
Operating frequency:	45-65 Hz		
Auxiliary Supply Voltage:	24 V - 240 V AC/DC		
AC Supply frequency:	45-65 Hz		
Supply voltage tolerance:	±10 %		
Auxiliary Voltage Burden (Max):	3 VA / 1.2 W		
Max. dissipated power (Un + terminals):	2.5 W		
Over-voltage range (Umax):	100-130 %Un		
Under-voltage range (Umin):	70-100 %Un		
Differential:	Adjustable 1-15 %Un		
Trip time delay:	Adjustable 0.5 to 10s		
Relay contacts:	2 x changeover, volt-free, for general switching operations		
Load capacity - AC:	250 V @ 8 A, 2 kVA		
Load capacity - DC:	30 V 8A		
Insulation:	4 kV/1 min		
Mechanical endurance:	30 x 10 ⁶ operations		
Other Data			
Operating temperature:	-20 to +55 °C		
Storage temperature:	-30 to +70 °C		
Over-voltage category:	III		
Pollution degree:	2		
Environmental protection:	IP40 for front panel, IP20 for terminals		
Maximum conductor size:	2 x 1.5 mm ² or 1 x 2.5 mm ²		
Dimensions:	90 x 52 x 64 mm		
Weight:	138 g		
Standards:	EN 60255-6, EN 60255-27, EN 61000-6-2, EN 61000-6-4		

Connection

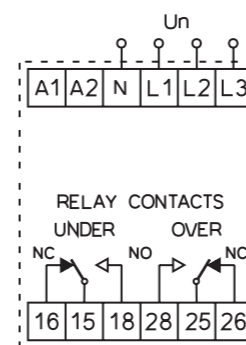

- These units monitor a 3-phase 4-wire supply and operate relays if a phase-neutral voltage goes below or above set levels. Front panel controls allow selection of:
 - Under- and Over-voltage trip levels,
 - nominal rated voltage,
 - differential voltage for operating hysteresis and
 - time delay before a trip triggers a relay response.
- LEDs indicate power on and trip status. A relay with two changeover volt-free contacts is fitted.
- These instructions contain important safety information. Please read them thoroughly before commissioning, operation or maintenance of the unit.

Device description

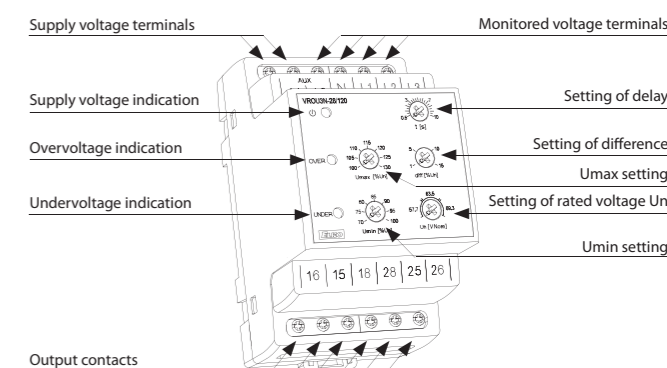

Function

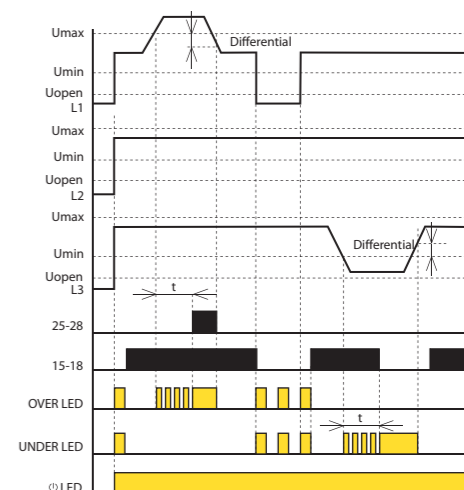

The time delay and differential trip levels help to prevent relay chatter as the monitored voltage level varies. As the relays have changeover contacts, the relay outputs can be inverted by wiring to the alternative terminals 15-16 or 25-26.

The unit obtains its power from the separate auxiliary supply. The green LED lights to shows when this supply is present. Under normal conditions, with all three phases at nominal level, both red LEDs will be off, the Under relay will be energised and the Over relay will be de-energised. With mains supply off, both relays will be de-energised.

Under-voltage Mode
If the monitored voltage of any phase goes below the set under-voltage level (Umin), the Under LED will light and the Under relay (15-16/18) will de-energise after the set delay. During the delay period, the Under LED will flash. If the voltage then returns above Umin plus the differential value, the Under LED will go off and the Under relay will energise again, without delay.

Over-voltage Mode
If the monitored voltage of any phase goes above the set over-voltage level (Umax), the Over LED will light and the Over relay (25-26/28) will energise after the set delay. During the delay period, the Over LED will flash. If the voltage then falls below Umax minus the differential value, the Over relay will de-energise and the Over LED will go off, without delay.

Note; Red LED indicates fault condition, not relay status.



EAN code
 VRU3N-28/120: 8595188154468
 VRU3N-28/240: 8595188154475
 VRU3N-28/480: 8595188154482

Technical parameters	VRU3N-28/120	VRU3N-28/240	VRU3N-28/480
Nominal voltage range (Un):	57.7-69.3 V	100-139 V	220-277 V
	L-N		
Overload capacity			
- continuous:	87 V	174 V	346 V
- 10 s max:	104 V	209 V	416 V
Operating frequency:	45-65 Hz		
Auxiliary Supply Voltage:	24 V - 240 V AC/DC		
AC Supply frequency:	45-65 Hz		
Supply voltage tolerance:	±10%		
Auxiliary Voltage Burden (Max):	3 VA / 1.2 W		
Max. dissipated power (Un + terminals):	2.5 W		
Under-voltage range (Umin):	70-100 %Un		
Differential:	Adjustable 1-15 %Un		
Trip time delay:	Adjustable 0.5 to 10s		
Relay contacts:	2 x changeover, volt-free, for general switching operations		
Load capacity - AC:	250 V @ 8 A, 2 kVA		
Load capacity - DC:	30 V 8A		
Insulation:	4 kV/1 min		
Mechanical endurance:	30 x 10 ⁶ operations		
Other Data			
Operating temperature:	-20 to +55 °C		
Storage temperature:	-30 to +70 °C		
Over-voltage category:	III		
Pollution degree:	2		
Environmental protection:	IP40 for front panel, IP20 for terminals		
Maximum conductor size:	2 x 1.5 mm ² or 1 x 2.5 mm ²		
Dimensions:	90 x 52 x 64 mm		
Weight:	138 g		
Standards:	EN 60255-6, EN 60255-27, EN 61000-6-2, EN 61000-6-4		

Connection

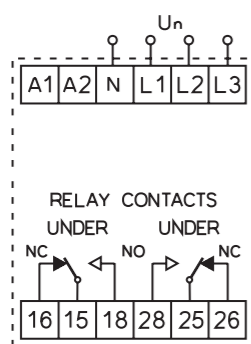

- These units monitor a 3-phase 4-wire supply and operate relays if a phase-neutral voltage goes below set levels. Front panel controls allow selection of:
 - Under voltage trip levels,
 - nominal rated voltage,
 - differential voltage for operating hysteresis and
 - time delay before a trip triggers a relay response.
- LEDs indicate power on and trip status. A relay with two changeover volt-free contacts is fitted.
- These instructions contain important safety information. Please read them thoroughly before commissioning, operation or maintenance of the unit.

Device description

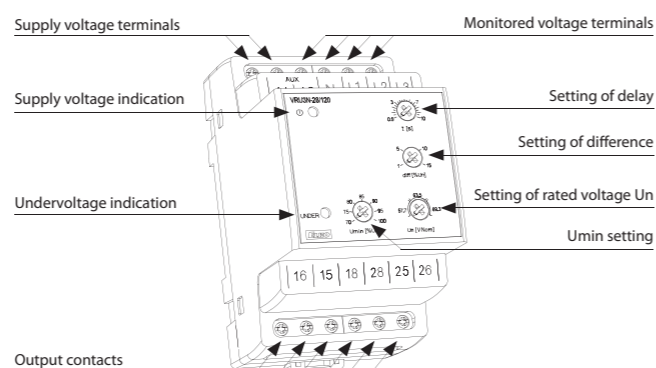

Function

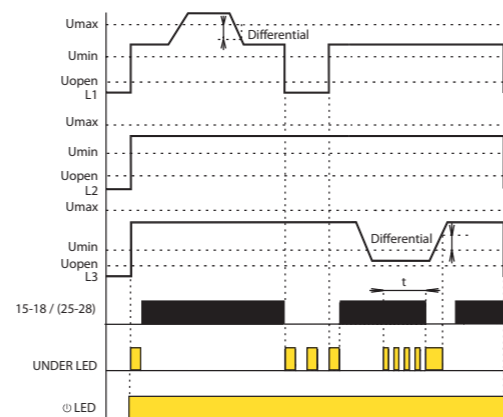

The time delay and differential trip levels help to prevent relay chatter as the monitored voltage level varies.

As the relays have changeover contacts, the relay outputs can be inverted by wiring to the alternative terminals 15-16 or 25-26.

The unit obtains its power from the separate auxiliary supply. The green LED lights to shows when this supply is present.

Under normal conditions, with all three voltages at nominal level, the red LED will be off, the Under relay will be energised. With mains supply off the relay will be de-energised.

Under-voltage Operation

If the monitored voltage of any phase goes below the set under-voltage level (Umin), the Under LED will light and the Under relay (15-16/18) & (25-26/28) will de-energise after the set delay. During the delay period, the Under LED will flash.

If the voltage then returns above Umin plus the differential value, the Under LED will go off and the Under relay will energise again, without delay. Note; Red LED indicates fault condition, not relay status.



EAN code
 VRO3N-28/120: 8595188155335
 VRO3N-28/240: 8595188155342
 VRO3N-28/480: 8595188155359

Technical parameters	VRO3N-28/120	VRO3N-28/240	VRO3N-28/480
Nominal voltage range (Un):	57.7-69.3 V	100-139 V	220-277 V
	L-N		
Overload capacity			
- continuous:	87 V	174 V	346 V
- 10 s max:	104 V	209 V	416 V
Operating frequency:	45-65 Hz		
Auxiliary Supply Voltage:	24 V - 240 V AC/DC		
AC Supply frequency:	45-65 Hz		
Supply voltage tolerance:	±10%		
Auxiliary Voltage Burden (Max):	3 VA / 1.2 W		
Max. dissipated power (Un + terminals):	2.5 W		
Over-voltage range (Umax):	100-125 %Un		
Differential:	Adjustable 1-15 %Un		
Trip time delay:	Adjustable 0.5 to 10s		
Relay contacts:	2 x changeover, volt-free, for general switching operations		
Load capacity - AC:	250 V @ 8 A, 2 kVA		
Load capacity - DC:	30 V 8A		
Insulation:	4 kV/1 min		
Mechanical endurance:	30 x 10 ⁶ operations		
Other Data			
Operating temperature:	-20 to +55 °C		
Storage temperature:	-30 to +70 °C		
Over-voltage category:	III		
Pollution degree:	2		
Environmental protection:	IP40 for front panel, IP20 for terminals		
Maximum conductor size:	2 x 1.5 mm ² or 1 x 2.5 mm ²		
Dimensions:	90 x 52 x 64 mm		
Weight:	138 g		
Standards:	EN 60255-6, EN 60255-27, EN 61000-6-2, EN 61000-6-4		

Connection

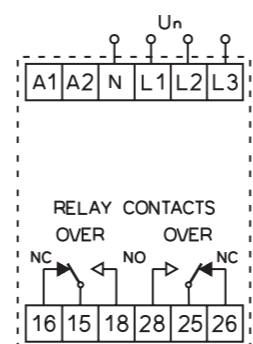

- These units monitor a 3-phase 4-wire supply and operate relays if a phase-neutral voltage goes below set levels. Front panel controls allow selection of:
 - Over voltage trip levels,
 - nominal rated voltage,
 - differential voltage for operating hysteresis and
 - time delay before a trip triggers a relay response.
- LEDs indicate power on and trip status. A relay with two changeover volt-free contacts is fitted.
- These instructions contain important safety information. Please read them thoroughly before commissioning, operation or maintenance of the unit.

Device description

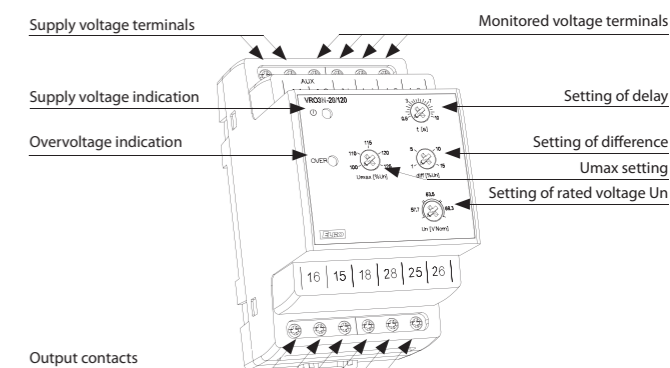

Function

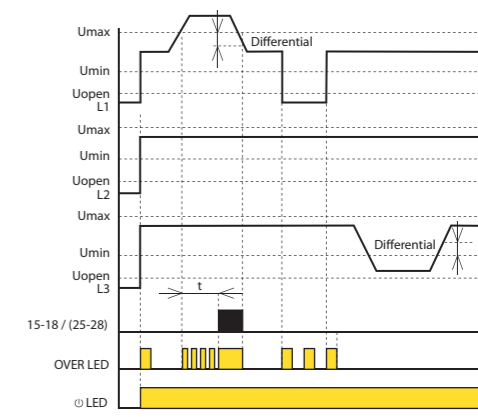

The time delay and differential trip levels help to prevent relay chatter as the monitored voltage level varies.

As the relays have changeover contacts, the relay outputs can be inverted by wiring to the alternative terminals 15-16 or 25-26.

The unit obtains its power from the separate auxiliary supply. The green LED lights to shows when this supply is present.

Over normal conditions, with all three voltages at nominal level, the red LED will be off, the Over relay will be de-energised. With mains supply off the relay will be de-energised.

Over-voltage Mode

If the monitored voltage of any phase goes above the set over-voltage level (Umax), the Over LED will light and the Over relay (15-16/18) & (25-26/28) will energise after the set delay. During the delay period, the Over LED will flash.

If the voltage then falls below Umax minus the differential value, the Over relay will de-energise and the Over LED will go off, without delay.

Note; Red LED indicates fault condition, not relay status.



EAN code
 VRSF3-18/120: 8595188142472 VRSF3N-18/120: 8595188142502
 VRSF3-18/240: 8595188142489 VRSF3N-18/240: 8595188142519
 VRSF3-28/480: 8595188142496 VRSF3N-28/480: 8595188142526

Technical parameters	120	240	480
Voltage range (Un Unom):			
VRSF3 L-L	100-120 V	173-240 V	380-480 V
VRSF3N L-N	58-69 V	100-139 V	220-277 V
Overload			
- contin.: VRSF3	150 V	300 V	600 V
VRSF3N	87 V	174 V	346 V
- 10s max: VRSF3	180 V	360 V	720 V
VRSF3N	104 V	209 V	416 V
Supply threshold (Umin):	Fixed at 85% of Unom		
Operating frequency (Fn):	45-65 Hz		
Burden on supply (Max):	3 VA / 1.7 W		
Max. dissipated power (Un + terminals):	2.5 W	2.5 W	3 W
Differential:	Fixed at 1% Unom		
Relay contacts: volt-free, for general switching operations	1 x c/o	2 x c/o	
Load capacity - AC:	250 V @ 8 A, 2 kVA		
Load capacity - DC:	30 V 8A		
Insulation:	4 kV/1 min		
Mechanical endurance:	30 x 10 ⁶ operations		

Other Data	
Operating temperature:	-20 to +55 °C
Storage temperature:	-30 to +70 °C
Over-voltage category:	III
Pollution degree:	2
Environmental protection:	IP40 for front panel, IP10 for terminals
Maximum conductor size:	2 x 2.5 mm ² or 1 x 4 mm ²
Dimensions:	90 x 17.6 x 64 mm
Weight:	63 g
Standards:	EN 60255-6, EN 60255-27, EN 61000-6-2, EN 61000-6-4

Connection

VRSF3-18/120(240)
(VRSF3N-18/120(240))

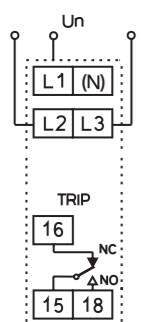

VRSF3-28/480
(VRSF3N-28/480)

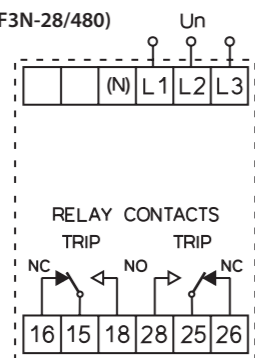

- This unit monitors the voltage levels and phase sequence of a three-phase supply and operates a relay if any phase voltage goes below a set level or if the phase sequence (L1, L2, L3) is incorrect. A front panel control allows selection of minimum voltage level. LEDs indicate power on and trip status.
- Versions are available to suit 3-wire, 3ph (VRSF3) and 4-wire, 3ph+N (VRSF3N) supplies of 110V, 220V and 430V nominal. The 110V and 230V versions occupy a single module width on the DIN rail and have a single relay contact whereas the 430V version occupies a three-module width and has two relay contacts.
- These instructions contain important safety information. Please read them thoroughly before commissioning, operating or maintenance of the unit.

Device description

VRSF3-18/120(240)
VRSF3N-18/120(240)

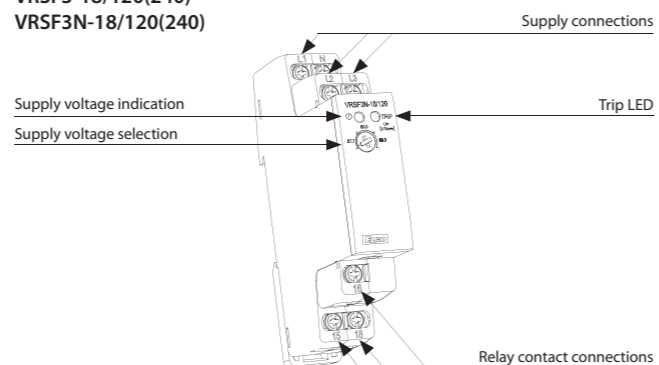

VRSF3-28/480
VRSF3N-28/480

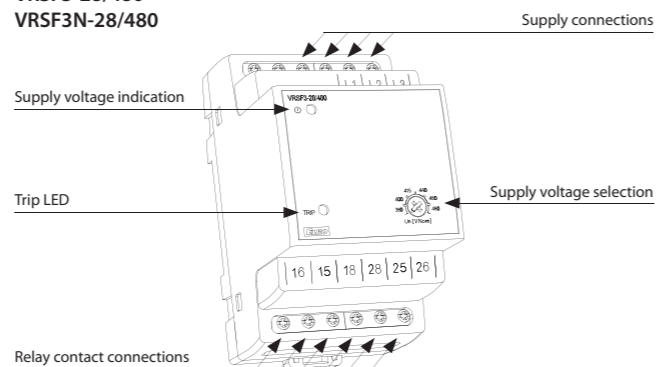

Function

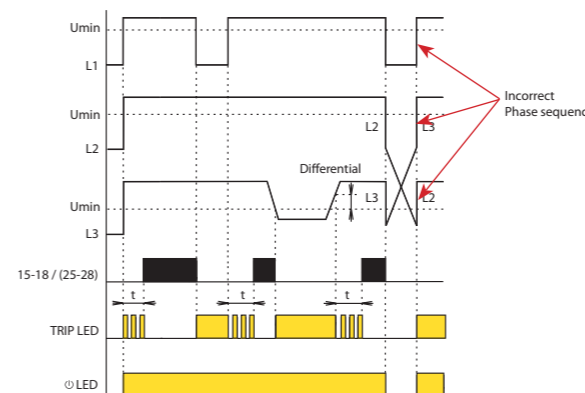

The time delay and differential trip levels help to prevent relay chatter as the monitored parameter fluctuates.

As the relay has changeover contacts, the relay outputs can be inverted by wiring to the alternative terminals 15-16 or 25-26.

The unit obtains its power supply from the supply being monitored. The green LED lights to show when this supply is present on at least one phase.

Under normal conditions, with the supply voltage at above minimum (threshold Umin) value and the phase sequencing correct (L1, L2, L3), the red LED will be off and the relay will be energised.

If the supply voltage falls below the minimum value Umin, the relay de-energises and the red Trip LED lights.

Similarly, if the supply phases are connected in the wrong sequence, e.g. L1, L3, L2, the relay de-energises and the red Trip LED lights.

Following a trip, the reset does not occur until the voltage exceeds Umin plus a differential. Then there is a delay before the relay energises again. The red Trip LED flashes during the delay period.

Note; Red LED indicates fault condition, not relay status.



EAN code
 VRBU3-18/120: 8595188142533 VRBU3N-18/120: 8595188142564
 VRBU3-18/240: 8595188142540 VRBU3N-18/240: 8595188142571
 VRBU3-28/480: 8595188142557 VRBU3N-28/480: 8595188142588

Technical parameters	120	240	480
Voltage range Un (Vnom):			
VRBU3 L-L	100-120 V	173-240 V	380-480 V
VRBU3N L-N	58-69 V	100-139 V	220-277 V
Overload			
- contin.: VRBU3	150 V	300 V	600 V
VRBU3N	87 V	174 V	346 V
- 10s max: VRBU3	180 V	360 V	720 V
VRBU3N	104 V	209 V	416 V
Max. operating voltage Uoff:	187 V	374 V	749 V
Burden on supply (Max):	3 VA / 1.7 W		
Max. dissipated power (Un + terminals):	2.5 W	2.5 W	3 W
Operating frequency:	45-65 Hz		
Phase imbalance trip level:	Adjustable 5-15% Un (Vnom)		
Differential:	Fixed at 1% Un (Vnom)		
Low-voltage trip level (Umin):	Adjustable 50-85% Un (Vnom)		
Trip delay t:	Adjustable 0.5 - 10s		
Relay contacts: volt-free, for general switching operations:	1 x c/o	2 x c/o	
Load capacity - AC:	250 V @ 8 A, 2 kVA		
Load capacity - DC:	30 V 8A		
Insulation:	4 kV/1 min		
Mechanical endurance:	30 x 10 ⁶ operations		
Other Data			
Operating temperature:	-20 to +55 °C		
Storage temperature:	-30 to +70 °C		
Over-voltage category:	III		
Pollution degree:	2		
Environmental protection:	IP40 for front panel, IP10 for terminals	IP40 for front panel, IP20 for terminals	
Maximum conductor size:	2 x 2.5 mm ² or 1 x 4 mm ²	2 x 1.5 mm ² or 1 x 2.5 mm ²	
Dimensions:	90 x 17.6 x 64 mm	90 x 52 x 64 mm	
Weight:	66 g	123 g	
Standards:	EN 60255-6, EN 60255-27, EN 61000-6-2, EN 61000-6-4		

- This unit monitors a 3-phase supply for phase imbalance, low or missing phases or incorrect phase sequence and trips a relay if it detects any anomaly. A front panel control allows selection of minimum voltage level. LEDs indicate power on and trip status.
- Versions are available to suit 3-wire, 3ph (VRBU3) and 4-wire, 3ph+N (VRBU3N) supplies of 110V, 210V and 430V nominal. The 110V and 120V versions occupy a single module width on the DIN rail and have a single relay contact whereas the 430V version occupies a three-module width and has two relay contacts.
- These instructions contain important safety information. Please read them thoroughly before commissioning, operating or maintenance of the unit.

Device description

VRBU3-18/120(240)
 VRBU3N-18/120(240)

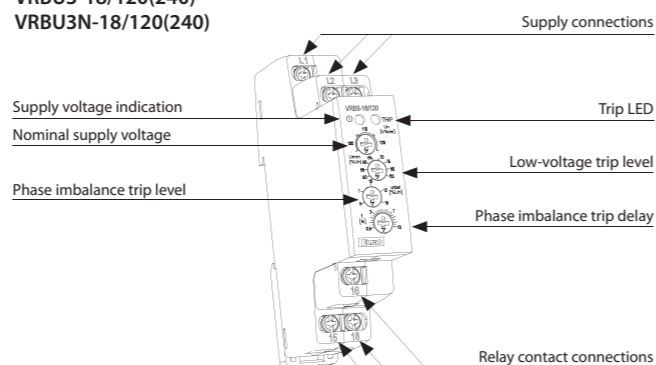

VRBU3-28/480
 VRBU3N-28/480

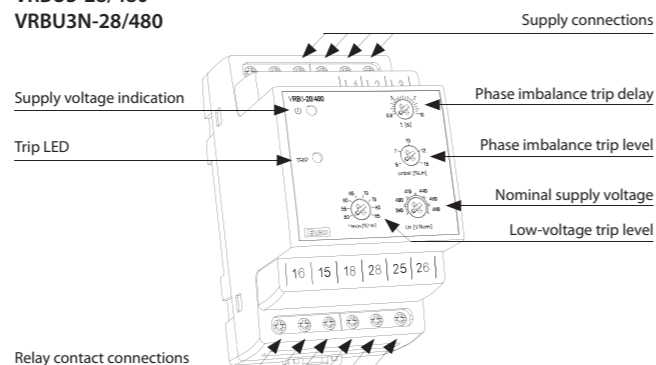

Connection

VRBU3-18/120(240)
 (VRBU3N-18/120(240))

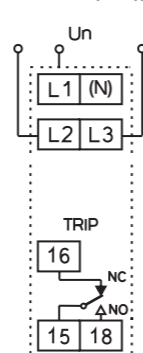

VRBU3-28/480
 (VRBU3N-28/480)

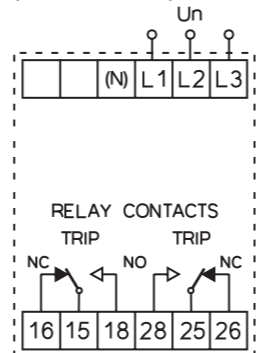

Function

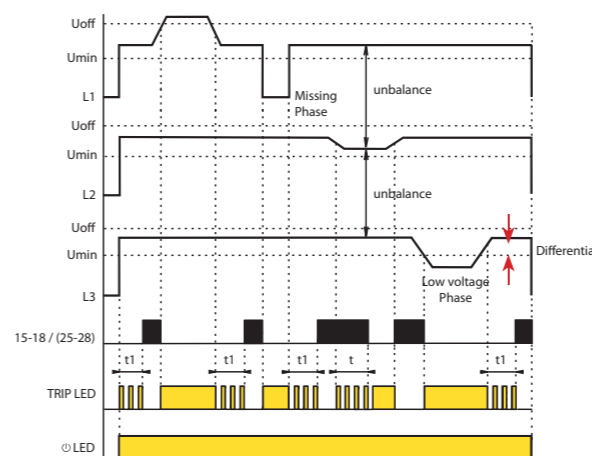

The time delay and differential trip levels help to prevent relay chatter as the monitored parameter fluctuates.

As the relay has changeover contacts, the relay outputs can be inverted by wiring to the alternative terminals 15-16 or 25-26.

The unit obtains its power supply from the supply being monitored. The green LED lights to show when this supply is present on at least one phase.

Under normal conditions, with all phases present at nominal levels (above Umin), balanced and connected in the correct sequence (L1, L2, L3), the red LED will be off and the relay will be energised.

When a trip occurs, the red LED lights and the relay De-energises. A trip will occur if:

- a supply phase falls below a set minimum value Umin or goes above a maximum limit Uoff.
- a phase is lost,
- one phase voltage differs from the others by more than the percentage set by the imbalance trip level control. This trip will be delayed by the time t set by the front panel control, OR
- If the supply phases are connected in the wrong sequence, e.g. L1, L3, L2.

After the cause of a trip has been removed, there will be a short, fixed delay t1 before a reset occurs, the relay energises again and the red LED goes off. Following a low voltage trip, the reset does not occur until the voltage exceeds Umin plus a differential. The red Trip LED flashes during any delay period.



EAN code
CROU1-28/1: 8595188142090
CROU1-28/5: 8595188142106

Technical parameters	CROU1-28/1	CROU1-28/5
Monitored supply		
Load current rating In:	1 A	5 A
Maximum overload		
- permanent:	2 A	10 A
- for 3s max:	20 A	50 A
Operating frequency:	45-65 Hz	
Current trip level - adjustable:	40-120% of In	
Trip time delay - adjustable:	0.5 to 10s	
Hysteresis differential:	Preset to 1% of range	
Auxiliary supply		
	24-240V AC or DC ±10%	
Burden on supply (Max):	3 VA / 1.2 W	
Max. dissipated power (Un + terminals):	2.5 W	
AC frequency range	45-65 Hz	
Relay contacts:	2 x changeover, volt-free, for general switching operations	
Load capacity - AC:	250 V @ 8 A, 2 kVA	
Load capacity - DC:	30 V 8A	
Insulation:	4 kV/1 min	
Mechanical endurance:	30 x 10 ⁶ operations	
Other Data		
Operating temperature:	-20 to +55 °C	
Storage temperature:	-30 to +70 °C	
Over-voltage category:	III	
Pollution degree:	2	
Environmental protection:	IP40 for front panel, IP20 for terminals	
Maximum conductor size:	2 x 1.5 mm ² or 1 x 2.5 mm ²	
Dimensions:	90 x 52 x 64 mm	
Weight:	129 g	
Standards:	EN 60255-6, EN 60255-27, EN 61000-6-2, EN 61000-6-4	

Connection

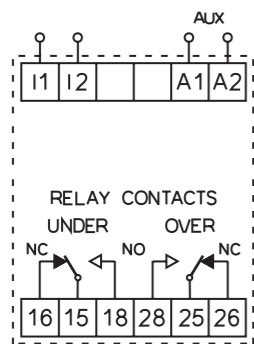

- These units monitor the AC current to a load and operate relays if the current goes below or above a set level. Front panel controls allow selection of:
 - Under and Over-current operation,
 - current trip level and
 - time delay before a trip triggers a relay response.
- LEDs indicate power on and trip status. A relay with two changeover volt-free contacts is fitted.
- Two versions for each type are available for monitoring currents of up to 1A (CROU1-28/1) and 5A (CROU1-28/5).
- The unit can be powered either by a separate auxiliary supply of 24-240V AC or DC or by the monitored supply, if suitable.
- These instructions contain important safety information. Please read them thoroughly before commissioning, operation or maintenance of the unit.

Device description

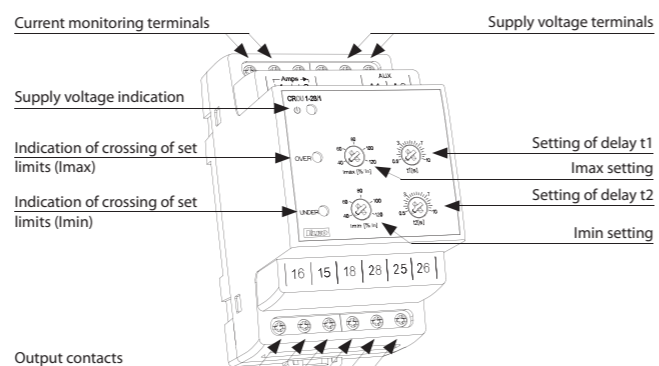

Function

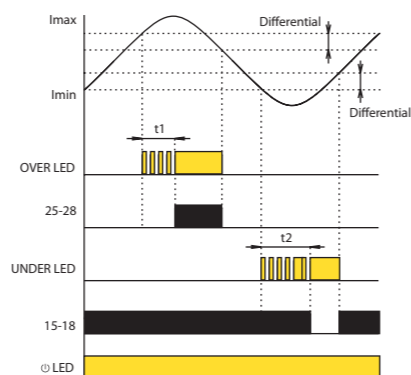

The time delay and differential trip levels help to prevent relay chatter as the monitored current level varies. As the relays have changeover contacts, the relay outputs can be inverted by wiring to the alternative terminals 15-16 or 25-26.

Under-current Mode

While the monitored current is greater than the set level Imin, the Under relay is energised (NO contacts 15-16 are closed) and the red Under LED is off.

If the current goes below the set level Imin, after the set time delay, the Under relay de-energises, contacts 15-18 open and the red Under LED lights. During the delay period, the LED flashes.

When the current returns above the set level Imin plus the under-current differential of 1%, the relay changes back without delay and the Under LED goes off.

Over-current Mode

While the monitored current is less than the set level Imax, the Over relay is deenergised (NO contacts 25-26 are open) and the Over red LED is off.

If the current goes above the set level Imax, after the set time delay, the Over relay energises, contacts change over (contacts 25-28 close) and the red Over LED lights. During the delay period, the Over LED flashes.

When the current returns below the set level Imax minus the over-current differential of 1%, the relay changes back without delay and the Over LED goes off.

Note; Red LED indicates fault condition, not relay status.



EAN code
CRU1-18/1: 8595188142076
CRU1-18/5: 8595188142083
CRO1-18/1: 8595188142113
CRO1-18/5: 8595188142120

Technical parameters	CRU1-18/1	CRO1-18/1	CRU1-18/5	CRO1-18/5
Monitored supply				
Load current rating In:	1 A		5 A	
Max. overload				
- permanent:	2 A		10 A	
- for 3s max:	20 A		50 A	
Operating frequency:	45-65 Hz			
Current trip level - adjustable (In):	40-120% of In			
Trip time delay - adjustable:	0.5 to 10s			
Hysteresis differential:	Preset to 1% of range			
Auxiliary supply				
	24-240V AC or DC ±10%			
Burden on supply (Max):	3 VA / 1.2 W			
Max. dissipated power (Un + terminals):	2 W			
AC frequency range:	45-65 Hz			
Relay contacts:	1 x changeover, volt-free, for general switching operations			
Load capacity - AC:	250V @ 8A, 2 kVA			
Load capacity - DC:	30V 8A			
Insulation:	4 kV/1 min			
Mechanical endurance:	30 x 10 ⁶ operations			
Other Data				
Operating temperature:	-20 to +55 °C			
Storage temperature:	-30 to +70 °C			
Overvoltage category:	III			
Pollution degree:	2			
Environmental protection:	IP40 for front panel, IP10 for terminals			
Maximum conductor size:	2 x 2.5 mm ² or 1 x 4 mm ²			
Dimensions:	90 x 17.6 x 64 mm			
Weight:	70 g			
Standards:	EN 60255-6, EN 60255-27, EN 61000-6-2, EN 61000-6-4			

Connection

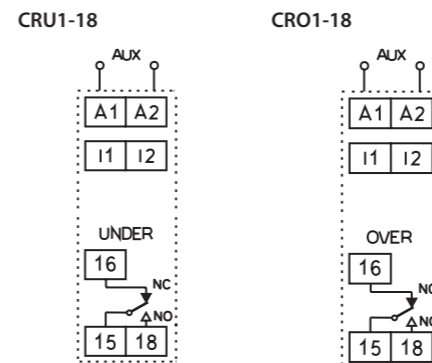

- These units monitor the AC current to a load and operate relays if the current goes below or above a set level. Front panel controls allow selection of:
 - Under (CRU1-18) - or Over (CRO1-18)-current operation,
 - current trip level and
 - time delay before a trip triggers a relay response.
- LEDs indicate power on and trip status. A relay with volt-free changeover contacts is fitted.
- Two versions for each type are available for monitoring currents of up to 1A (CRU1-18-1, CRO1-18/1) and 5A (CRU1-18/5, CRO1-18/5)
- The unit can be powered either by a separate auxiliary supply of 24-240V AC or DC or by the monitored supply, if suitable.
- These instructions contain important safety information. Please read them thoroughly before commissioning, operation or maintenance of the unit.

Description

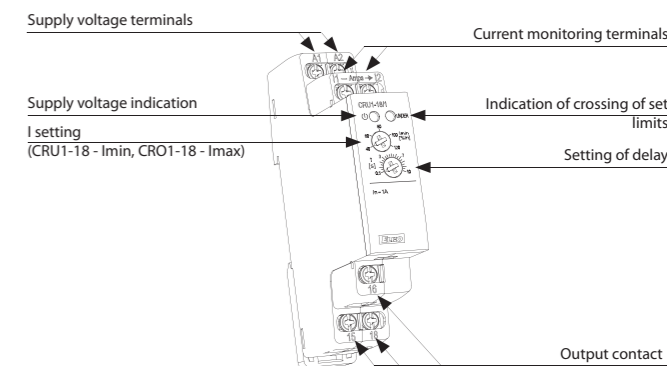

Function

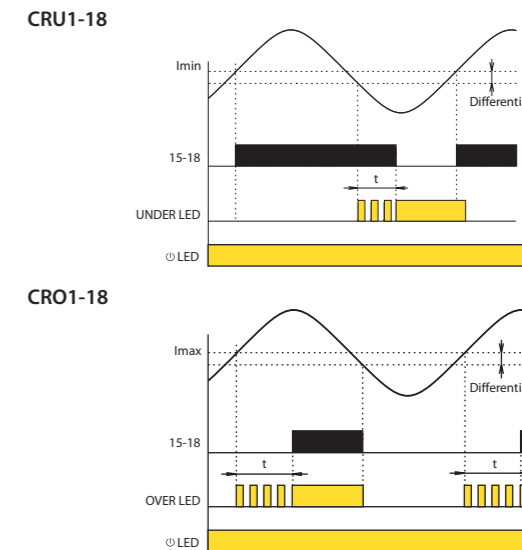

The time delay and differential trip levels help to prevent relay chatter as the monitored current level varies. As the relays have changeover contacts, the relay outputs can be inverted by wiring to the alternative terminals 15-16 or 25-26.

Under-current Mode (Model CRU1-18)

While the monitored current is greater than the set level Imin, the relay is energised (NC contacts 15-16 are open) and the red LED is off.

If the current goes below the set level Imin, after the set time delay, the relay de-energises, contacts 15-16 close and the red LED lights. During the delay period, the LED flashes.

When the current returns above the set level Imin plus the under-current differential of 1%, the relay changes back without delay and the LED goes off.

Over-current Mode (Model CRO1-18)

While the monitored current is less than the set level Imax, the relay is de-energised (NO contacts 15-18 are open) and the red LED is off.

If the current goes above the set level Imax, after the set time delay, the relay energise, contacts change over (contacts 15-18 close) and the red LED lights. During the delay period, the LED flashes.

When the current returns below the set level Imax minus the over-current differential of 1%, the relay changes back without delay and the LED goes off. Note; Red LED indicates fault condition, not relay status



EAN code
CRGF1-28/24: 8595188142755
CRGF1-28/240: 8595188142762

Technical parameters	CRGF1-18/240	CRGF1-18/24
Supply terminals:	A1, A2	
Monitoring terminals (for current shunt):	N, G	
External current shunt:	0.2 mΩ or 2 mΩ	
Supply voltage:	24-240 V AC/DC (45-65 Hz)	12 - 24 V DC
Burden on supply (Max):	3 VA / 1 W	
Max. dissipated power (Un + terminals):	2.5 W	
Adjustable current level:	100A, 150A, 200A, 250A, 300A, 450A, 600A, 750A, 800A, 1200A,	
Overload capacity:	max. input voltage 600V (in case of shunt failure)	
Indication of exceeding the monitored current:	60% I _{max} - red LED TRIP 60% 100% I _{max} - red LED TRIP 100%	
Adjustable delay:	0 s / 0.1s / 0.2s / 0.4s / 0.6s / 0.8s / 1s / 2s / 5s / 10s*	
Response time:	max. 40ms	
Analogue output:	0 - 1mA = 0...100% set current values	
Output relay - contact:	2x switchable (AgNi) gilded	
AC contact capacity:	250V / 8 A, max. 2000VA	
DC contact capacity:	30V / 8A	
Mechanical service life:	3x10 ⁶ at rated load	

Other data		
Working temperature:	-20.. +55 °C	
Storage temperature:	-30.. +70 °C	
Dielectric strength (power supply - contact relay):	4 kV / 1min	
Excess voltage category:	III.	
Contamination degree:	2	
Protection:	IP 40 from the front panel / IP20 terminals	
Maximum conductor size:	max. 2 x 1.5mm ² / 1 x 2.5mm ²	
Dimension:	90 x 52 x 64 mm	
Weight:	128 g	125 g

* If the set current value is exceeded 5 times the time delay is ignored.

- monitors the dangerous value of the leakage ground current that can cause e.g. undesirable overheating of cables and a subsequent failure of the device or even dangerous voltage of the grounded device
- serves as protection of electrical engines, generators, transformers and other devices
- continuous monitoring of the current value using an external current shunt
- very short response time (< 40ms)
- step-adjustable value of monitored current (in 10 steps)
- step-adjustable response delay (in 10 steps)
- indication of exceeding 2 levels of monitored current (60 and 100% I_{max})
- selection of the value of a shunt on the device panel - 0.2 mΩ or 2 mΩ
- switching the relay mode on the device panel - LATCH ON or OFF
- RESET & TEST button for the return to the initial state or device test
- analogue output 0...1mA for the control meter
- 2 types according to the value of the supply voltage: 24 - 240V AC/DC or 12 - 24V DC
- 3-module version, mounted onto the DIN rail

Device description

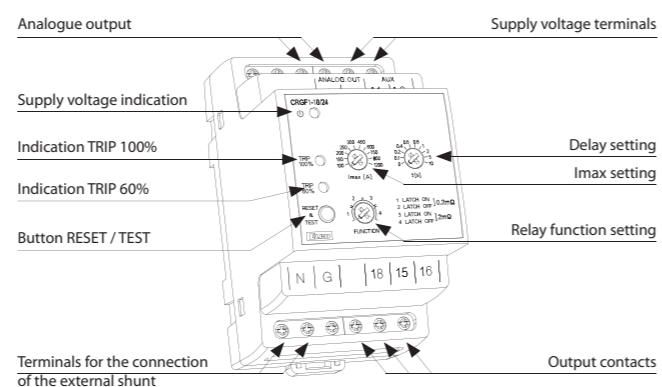

Connection

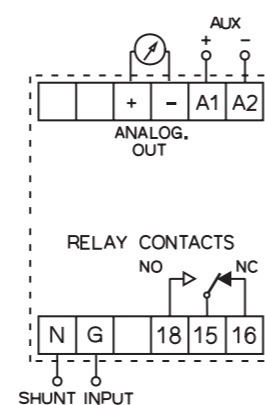

N - neutral (neutral conductor)
G - ground (grounding conductor)

Function

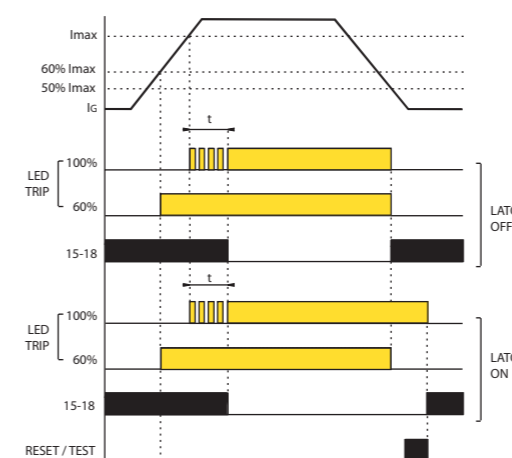

Function description

After the connection of the supply voltage to the supply terminals (A1-A2) the green LED goes on and the output relay is activated. The device is monitoring the value of the ground current (AC voltage from the shunt at terminals N, G) by means of the external current shunt. If the current value exceeds 60% of the set value I_{max} the red LED TRIP 60% goes on. When the set value of the I_{max} current (100%) is exceeded after the elapse of the delay timing the relay is disconnected and the red LED TRIP goes on. The red LED flashes during the timing.

If the set current value is exceeded 5 times the relay is disconnected without delay.

LATCH ON function description

If the current value drops below the set value of 50% I_{max} both the relay and the red LED TRIP 100% remain unchanged. LED TRIP 60% goes off.

The relay returns into the idle state (is activated) by briefly pressing the RESET & TEST button and the LED TRIP 100% goes off. It can also be reset by short-circuiting the input terminals (N, G).

LATCH OFF function description

If the current value drops below the set value of 50% I_{max} the relay and both the red LEDs return into the idle state (are activated).

By pressing and holding (for longer than 1s) the button the device test is activated - both the relays and the red LED respond in the same way as in the case of exceeding the set current value. After releasing the button the relay returns to the initial state.



EAN code
 CRRP1-28/120: 8595188145725 CRRP3-28/120: 8595188142670
 CRRP1-28/240: 8595188142656 CRRP3-28/240: 8595188142687
 CRRP1-28/480: 8595188142663 CRRP3-28/480: 8595188142694

Technical parameters	120	240	480
Voltage range (Vnom):			
CRRP1-28 ph-N	57.7-69.3 V	100-139 V	220-277 V
CRRP3-28 ph-ph	100-120 V	173-240 V	380-480 V
Overload			
- cont.: CRRP1-28	87 V	174 V	346 V
CRRP3-28	150 V	300 V	600 V
- 10s max: CRRP1-28	104 V	209 V	416 V
CRRP3-28	180 V	360 V	720 V
Max. power input:			
CRRP1-28	1.4 VA / 1 W	1.6 VA / 1.3 W	2.9 VA / 2.1 W
CRRP3-28	2.5 VA / 1.5 W	4.2 VA / 3.2 W	6 VA / 4 W
Max. dissipated power (Un + terminals):	2 W	2.5 W	3.5 W
Min supply voltage (Uopen):			
CRRP1-28	35 V	60 V	132 V
CRRP3-28	3x 60 V	3x 104 V	3x 228 V
Nominal currents In:	2A, 3A, 4A, 5A, 8A, 10A		
Operating frequency:	45-65 Hz		
Monitored current range:	2..100% In		
Monitored cos Φ range:	0.2 inductive to 0.2 capacitive		
Reverse power setpoint range:	2..20% (cos Φ =1)		
Differential:	fixed at 1%		
Trip delay t:	Adjustable 0.5 - 20s		
Relay contacts:	2 x changeover, volt-free, for general switching operations		
Load capacity - AC:	250 V @ 8 A, 2 kVA		
Load capacity - DC:	30 V 8A		
Insulation:	4 kV / 1 min		
Mechanical endurance:	30 x 10 ⁶ operations at rated load		
Other Data			
Operating temperature:	-20 to +55 °C		
Storage temperature:	-30 to +70 °C		
Over-voltage category:	III		
Pollution degree:	2		
Environmental protection:	IP40 for front panel, IP20 for terminals		
Maximum conductor size:	2 x 1.5 mm ² or 1 x 2.5 mm ²		
Dimensions:	90 x 105 x 64 mm		
Weight:			
CRRP1-28	199 g	199 g	203 g
CRRP3-28	201 g	204 g	211 g
Standards:	EN 60255-6, EN 60255-27, EN 61000-6-2, EN 61000-6-4		

- This unit monitors a single- or three-phase supply for reverse power and trips a relay if it detects reverse power ($I \times \cos \Phi$) over a set limit. The relay output is typically used to prevent 'motoring' of a generator (where the generator turns the engine), which can damage the engine.
- Front panel controls allow selection of trip level, nominal operating current and trip delay. LEDs indicate power on and trip status.
- Versions are available to suit 3-phase 3-wire L-L (CRRP3-28) and 3-phase 4-wire L-N (CRRP1-28) systems.
- These instructions contain important safety information. Please read them thoroughly before commissioning, operating or maintenance of the unit.

Device description

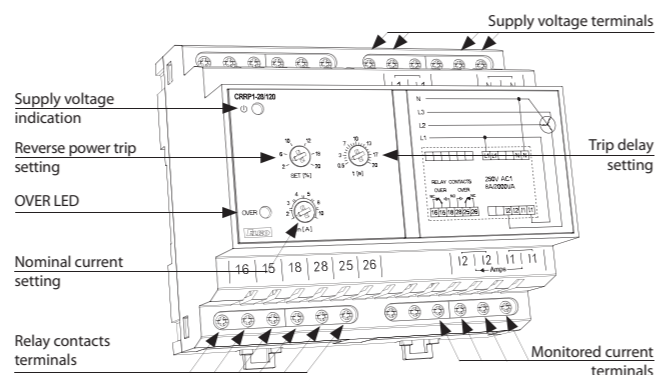

Connection

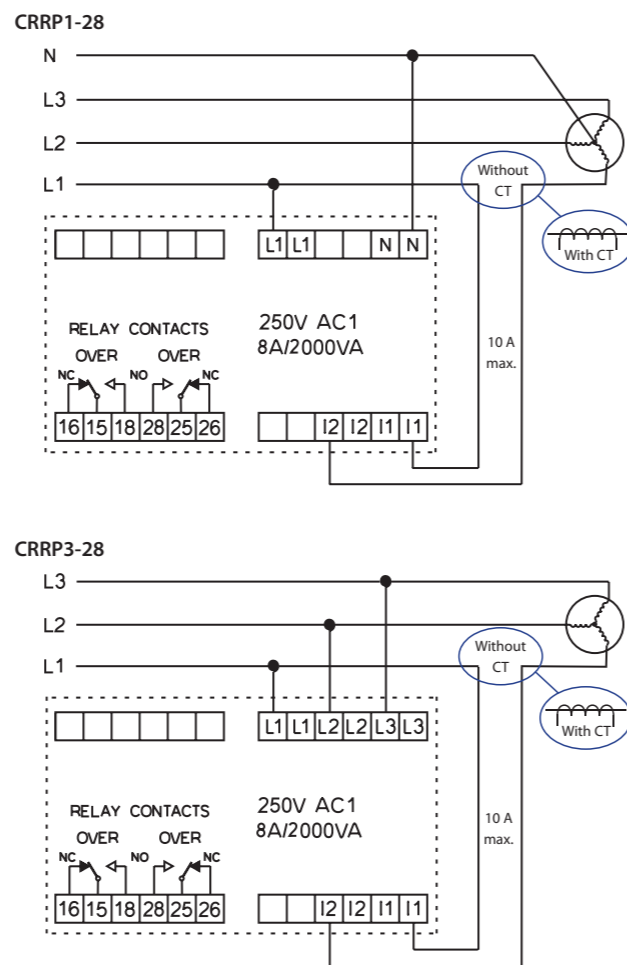

Function

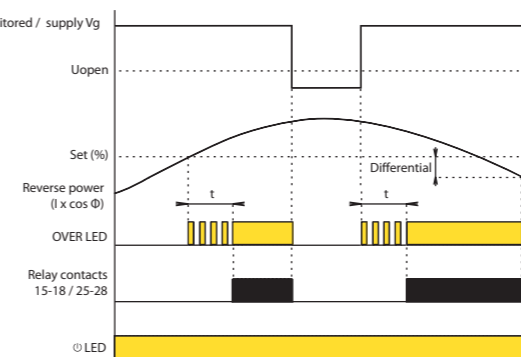

The time delay and differential trip levels help to prevent relay chatter as the monitored parameters fluctuate.

As the relay has changeover contacts, the relay outputs can be inverted by wiring to the alternative terminals 15-16 or 25-26.

The unit obtains its power supply from the supply being monitored. The green LED lights to show when this supply is present on at least one phase.

Under normal forward current conditions, the red LED will be off and the relay will be de-energised.

If the reverse power ($I \times \cos \Phi$) exceeds the set level, the relay energises and the red OVER LED lights after the time delay set by the trip delay control. The red LED flashes during the delay period.

When the reverse power falls below the set level plus the 1% differential, the relay de-energises and the red OVER LED goes off.

If the monitored supply voltage falls below the minimum level Uopen, the relay de-energises and the red OVER LED goes off.



EAN code
FRSS1-38/130: 8595188142700

Technical parameters	FRSS1-38/130
Supply voltage:	12-24 V DC
Supply voltage tolerance:	+20 / -10 %
Burden on supply (max.):	2 W
Max. dissipated power (Un + terminals):	3.5 W
Input pulse amplitude:	5-75V p-p
Frequency range:	0-1 kHz min, 0-10 kHz max
Trip settings:	w.r.t calibrated speed:
Cranking:	10-50%
Under-speed:	50-100%
Over-speed:	100-130%
Differential:	Fixed at 2%
Analogue (meter) output:	0-1 mA
at 100% rated speed:	0.75 mA
at 133% rated speed:	1 mA
Relay contacts:	3 x changeover, volt-free, for general switching operations
Load capacity - AC:	250 V @ 8 A, 2 kVA
Load capacity - DC:	30 V 8A
Insulation:	4 kV/1 min
Mechanical endurance:	30 x 10 ⁶ operations
Other Data	
Operating temperature:	-20 to +55 °C
Storage temperature:	-30 to +70 °C
Over-voltage category:	III
Pollution degree:	2
Environmental protection:	IP40 for front panel, IP20 for terminals
Maximum conductor size:	2 x 1.5 mm ² or 1 x 2.5 mm ²
Dimensions:	90 x 52 x 64 mm
Weight:	133 g
Standards:	EN 60255-6, EN 60255-27, EN 61000-6-2, EN 61000-6-4

- This unit monitors the speed of rotating equipment using a magnetic pick-up and provides three relay outputs according to measured speeds. The pick-up could, for instance, detect teeth on a rotating gear or flywheel. The unit also provides a tachometer output for speed indication. The relay outputs can be used for alarm or control purposes. LEDs indicate power on and relay status.
- Controls on the front panel set the trip points at which the relays and LEDs operate:
 - Crank speed - set just above the speed of the crank motor.
 - Under speed - set below the normal running speed (<100%)
 - Over speed - set to the maximum permitted speed (>100%).
- The unit can be calibrated such that a standard 100% on the unit represents the required nominal engine speed.
- These instructions contain important safety information. Please read them thoroughly before commissioning, operating or maintenance of the unit.

Device description

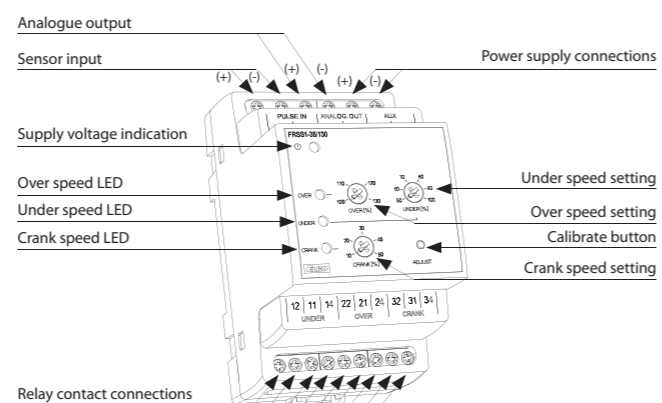

Connection

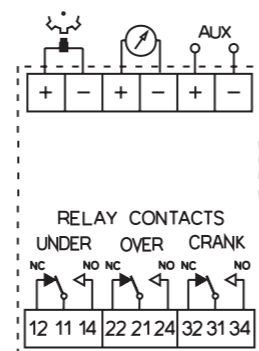

Calibration

The unit can be calibrated by supplying an appropriate input to the sensor input terminals and pressing the Adjust button for more than 3s. This input then becomes the 100% reference used by the meter.

The required sensor input can be obtained either by running the engine at the required speed or by providing a pulse input at the appropriate frequency from a pulse generator.

Function

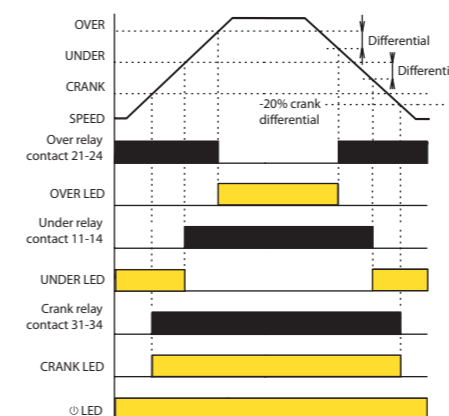

The differential trip levels help to prevent relay chatter as the monitored speed varies.

As the relays have changeover contacts, the relay outputs can be inverted by wiring to the alternative terminals 11-12, 21-22 or 31-32.

The green LED lights shows when the power supply is on.

With the motor running at its normal speed, between Under and Over speed settings, only the green and amber LEDs will be on and all three relays will be energised.

Crank

The Crank LED lights and the crank relay energises when the engine speed exceeds the Crank setting. This is normally set just above the cranking speed of the crank motor so that the unit indicates that the engine has started.

The LED goes off and the relay de-energises when the engine speed falls 20 % below the crank speed setting.

Under-speed

The Under LED goes off and the relay energises when the engine speed exceeds Under-speed control setting.

The LED lights and the relay de-energises when the engine speed falls below the Under-speed control setting minus a 2 % differential.

Over-speed

Normally, the Over relay is energised and the LED is off. If the engine speed exceeds the Over-speed limit setting, the Over relay de-energises and the LED lights. The relay remains de-energised with the LED on until the speed drops below the limit setting minus the 2 % differential.

Sensor disconnection

If the sensor becomes disconnected, the Over LED flashes, the Over relay deenergises, the Crank and Under relays energise and the Crank and Under LEDs light.



EAN code
CRMA1-28/24: 8595188145701
CRMA1-28/240: 8595188145718

Technical parameters	CRMA1-28/24	CRMA1-28/240
Supply voltage:	12-24V DC	24V-240V AC/DC
Burden on supply (max.):	1 W	3 VA / 0.9 W
Max. dissipated power (Un + terminals):	2 W	
AC Supply frequency:	45-65 Hz	
Supply voltage tolerance:	±10%	
Monitored DC current (I _{lin}):	0-1, 0-10 and 4-20 mA	
Voltage drop across input:	1V max. at 120% I _{lin}	
Over-current range (I _{max}):	40-120 % I _{lin}	
Under-current range (I _{min}):	0-80 % I _{lin}	
Overload capacity		
- continuous:	3 x I _{lin}	
- 1s max.:	10 x I _{lin}	
Differential:	Fixed at 1% I _{lin}	
Trip time delay:	Adjustable 0.5 to 10s	
Relay contacts:	2 x changeover, volt-free, for general switching operations	
Load capacity - AC:	250 V @ 8 A, 2 kVA	
Load capacity - DC:	30 V 8A	
Insulation:	4 kV/1 min	
Mechanical endurance:	30 x 10 ⁶ operations	

Other Data	
Operating temperature:	-20 to +55 °C
Storage temperature:	-30 to +70 °C
Over-voltage category:	III
Pollution degree:	2
Environmental protection:	IP40 for front panel, IP20 for terminals
Maximum conductor size:	2 x 1.5 mm ² or 1 x 2.5 mm ²
Dimensions:	90 x 52 x 64 mm
Weight:	135 g
Standards:	EN 60255-6, EN 60255-27, EN 61000-6-2, EN 61000-6-4

Connection

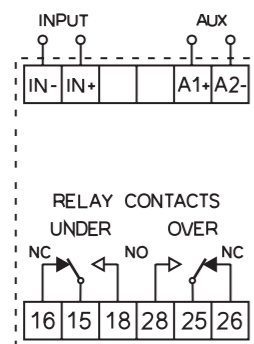

- These units monitor a current of 0-1, 0-10 or 4-20 mA, e.g. from a transducer, and operates one of two relays if the current goes above or below set levels. Front panel controls allow selection of:
 - under- and over-current trip levels I_{max}, I_{min}
 - nominal rated current of 0-1, 0-10 or 4-20 mA (I_{lin})
 - time delay before a trip triggers a relay response.
- LEDs indicate power on and trip status. Two changeover, volt-free relays are fitted.
- Two types are available - a 12-24 unit powered from 12-24V DC and a 24-240 unit powered from 24V-240V AC or DC
- These instructions contain important safety information. Please read them thoroughly before commissioning, operating or maintenance of the unit.

Device description

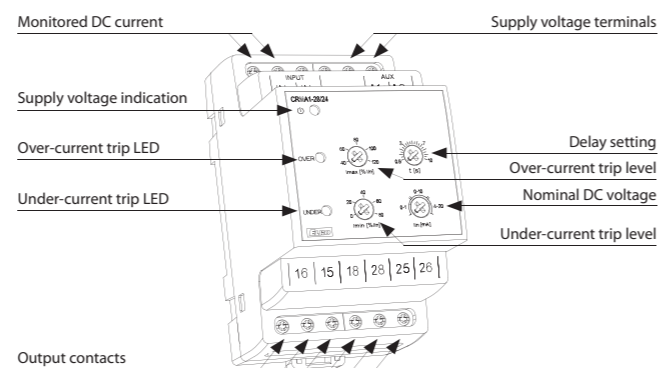

Function

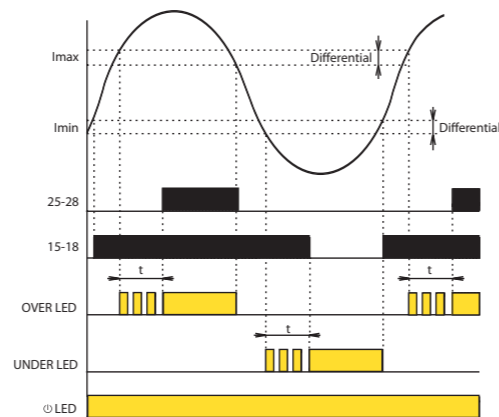

The time delay and differential trip levels help to prevent relay chatter as the monitored voltage level varies. As the relays have changeover contacts, the relay outputs can be inverted by wiring to the alternative terminals 15-16 or 25-26. The green LED lights to shows when the supply is present. Under normal conditions, with the monitored current at nominal levels, both red LEDs will be off, the Under relay will be energised and the Over relay will be de-energised. With supply voltage off, both relays will be de-energised.

Under-current Operation
If the monitored current goes below the set under-current level (I_{min}), the Under LED will light and the Under relay (15-16/18) will de-energise after the set delay. During the delay period, the Under LED will flash. If the current then returns above I_{min} plus the differential value, the Under LED will go off and the Under relay will energise again, without delay.

Over-current Operation
If the monitored current goes above the set over-current level (I_{max}), the Over LED will light and the Over relay (25-26/28) will energise after the set delay. During the delay period, the Over LED will flash. If the current then falls below I_{max} minus the differential value, the Over relay will de-energise and the Over LED will go off, without delay. Note; Red LED indicates fault condition, not relay status.

Installation contactors VS

VS120 Number of contacts: 1x20 A Configuration of switching and breaking contacts: 10, 01.	VS220 Number of contacts: 2x20 A Configuration of switching and breaking contacts: 20, 11, 02.	VS420 Number of contacts: 4x20 A Configuration of switching and breaking contacts: 40, 31.	VS425 Number of contacts: 4x25 A Configuration of switching and breaking contacts: 40, 31, 22, 04.	VS440 Number of contacts: 4x40 A Configuration of switching and breaking contacts: 40, 31, 22, 04.	VS463 Number of contacts: 4x63 A Configuration of switching and breaking contacts: 40, 31, 22.

Installation contactors with manual control VSM

VSM220 Number of contacts: 2x20 A Configuration of switching and breaking contacts: 20, 11, 02.	VSM425 Number of contacts: 4x25 A Configuration of switching and breaking contacts: 40, 31, 22, 04.

Accessories

VSK-11 Auxiliary contacts: 1x switching, 1x breaking.	VSK-20 Auxiliary contacts: 2x switching.

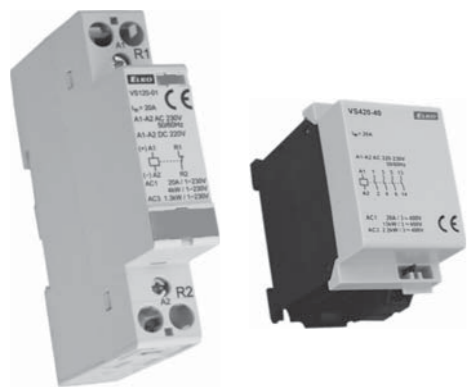

- For switching electric circuits, especially for resistive loads and three-phase induction motors:
 number of contacts VS120: 1
 number of contacts VS220: 2
 number of contacts VS420, VS425, VS440, VS463: 4
- It is produced in configuration of switching and breaking contacts:
 VS120: 10, 01
 VS220: 20, 11, 02
 VS420: 40, 31
 VS425: 40, 31, 22, 04
 VS440: 40, 31, 22, 04
 VS463: 40, 31, 22
- Protection IP20 - on request we deliver covers that ensure protection IP40 for all terminals.
- DIN rail or panel mounting.

EAN code see page 154

Technical parameters	VS120	VS220	VS420	VS425	VS440	VS463
Rated insulation voltage (Ui):	230 V	230 V	415 V	440 V	440 V	440 V
Rated thermo-current I _m (in AC):	20 A	20 A	20 A	25 A	40 A	63 A
Switched operation						
AC-1 for 400 V, 3 phase:	x	x	13 kW	16 kW	26 kW	40 kW
AC-1 for 230 V:	4 kW, 1 phase	4 kW, 1 phase	7.5 kW, 3 phase	9 kW, 3 phase	16 kW, 3 phase	24 kW, 3 phase
AC-3 for 400 V, 3 phase:	x	x	2.2 kW	4 kW	11 kW	15 kW
AC-3 for 230 V:	1.3 kW only NO, 1 phase	1.3 kW only NO, 1 phase	1.1 kW, 3 phase	2.2 kW, 3 phase	5.5 kW, 3 phase	8.5 kW, 3 phase
AC-7a for 400 V, 3 phase:	x	x	13 kW	16 kW	26 kW	40 kW
AC-7a for 230 V:	4 kW, 1 phase	4 kW, 1 phase	7.5 kW, 3 phase	9 kW, 3 phase	16 kW, 3 phase	24 kW, 3 phase
AC-7b for 400 V, 3 phase:	x	x	2.2 kW	4 kW	11 kW	15 kW
AC-7b for 230 V:	1.3 kW only NO, 1 phase	1.3 kW only NO, 1 phase	1.1 kW, 3 phase	2.2 kW, 3 phase	5.5 kW, 3 phase	8.5 kW, 3 phase
AC-15 for 400 V, 1 phase:	4 A	4 A	4 A	4 A	4 A	4 A
AC-15 for 230 V, 1 phase:	6 A	6 A	6 A	6 A	6 A	6 A
DC1 U _e = 24 V:	20 A	20 A	20 A	25 A	40 A	63 A
DC1 U _e = 110 V:	6 A	6 A	2 A	6 A	4 A	4 A
DC1 U _e = 220 V:	0.6 A	0.6 A	0.5 A	0.6 A	1.2 A	1.2 A

Loadability of modular contactors see page 153

The max. number of switching for max. load:	600 switch/hr.	600switch/hr.	600 switch/hr.	600 switch/hr.	600 switch/hr.	600 switch/hr.
---	----------------	---------------	----------------	----------------	----------------	----------------

Electrical life in 230 / 400 V						
AC-1-resistive load :	0.2x10 ⁶	0.2x10 ⁶	0.2x10 ⁶	0.2x10 ⁶	0.1x10 ⁶	0.1x10 ⁶
AC-3-power load:	0.3x10 ⁶	0.3x10 ⁶	0.3x10 ⁶	0.5x10 ⁶	0.15x10 ⁶	0.15x10 ⁶
AC-5a - high-intensity discharge lamp:	0.1x10 ⁶ by 30 μF	0.1x10 ⁶ by 30 μF	0.3x10 ⁶ by 36 μF	0.1x10 ⁶ by 36 μF	0.1x10 ⁶ by 220 μF	0.1x10 ⁶ by 330 μF
AC-5b - incandescent lamps :	0.1x10 ⁶ by 2 kW	0.1x10 ⁶ by 2 kW	0.1x10 ⁶ by 2 kW	0.1x10 ⁶ by 2 kW	0.1x10 ⁶ by 4 kW	0.1x10 ⁶ by 5 kW
AC-7a - resistive household devices:	0.2x10 ⁶	0.2x10 ⁶	0.2x10 ⁶	0.2x10 ⁶	0.1x10 ⁶	0.1x10 ⁶
AC-7b - inductive household devices:	0.3x10 ⁶	0.3x10 ⁶	0.3x10 ⁶	0.3x10 ⁶	0.15x10 ⁶	0.15x10 ⁶
Minimal load:	≥ 17 V, ≥ 50 mA	≥ 17 V, ≥ 50 mA	≥ 17 V, ≥ 50 mA	≥ 17 V, ≥ 50 mA	≥ 17 V, ≥ 50 mA	≥ 24 V, ≥ 100 mA
Short circuit protection with the fuse char. aM:	20 A	20 A	20 A	25 A	63 A	80 A
Coordination Type according EN 60 947-4-1:	2	2	2	2	2	2
Electrical strenght:	4 kV	4 kV	4 kV	4 kV	4 kV	4 kV

Contacts - max. cable size						
Solid conductor:	AWG 7 (10 mm ²)	AWG 7 (10 mm ²)	AWG 10 (2.5 mm ²)	AWG 7 (10 mm ²)	AWG 3 (25 mm ²)	AWG 3 (25 mm ²)
Stranded conductor:	6 mm ²	6 mm ²	2.5 mm ²	6 mm ²	16 mm ²	16 mm ²
Maximal torque:	1.2 Nm	1.2 Nm	1.2 Nm	1.2 Nm	3.5 Nm	3.5 Nm

Coil - max. cable size						
Solid conductor:	AWG 10 (2.5 mm ²)	AWG 10 (2.5 mm ²)	AWG 10 (2.5 mm ²)	AWG 10 (2.5 mm ²)	AWG 10 (2.5 mm ²)	AWG 10 (2.5 mm ²)
Stranded conductor:	2.5 mm ²	2.5 mm ²	2.5 mm ²	2.5 mm ²	2.5 mm ²	2.5 mm ²
Max. torque:	0.6 Nm	0.6 Nm	0.6 Nm	0.6 Nm	0.6 Nm	0.6 Nm

Operating						
Coil control voltage:	AC/DC 24 V, 230 V	AC/DC 24 V, 48 V, 110 V, 230 V	AC 12 V, 24 V, 48 V, 110 V, 230 V	AC/DC 24 V, 48 V, 110 V, 230 V	AC/DC 24 V, 110 V, 230 V	AC/DC 24 V, 48 V, 110 V, 230 V
Coil permanent supply +/- 10 %:	2.1 VA/2.1 W	2.1 VA/2.1 W	5 VA/1.5 W	2.6 VA/2.6 W *	5 VA/5 W	5 VA/5 W
Coil gear supply +/- 10 %:	2.1 VA/2.1 W	2.1 VA/2.1 W	30 VA/25 W	2.6 VA/2.6 W *	5 VA/5 W	5 VA/5 W
Mounting side-by-side:	max. 2 contactors**	max. 2 contactors**	max. 2 contactors**	max. 2 contactors**	max. 2 contactors**	max. 2 contactors**
Operational temperature:	-5 ... +55 °C (23.. 131 °F)					
Storing temperature:	-30... +80 °C (-22.. 176 °F)					
Weight:	120 g (4.2 oz.)	130 g (4.6 oz.)	170 g (6 oz.)	213 g (7.5 oz.)	400 g (14 oz.)	400 g (14 oz.)
Dimensions:	17.5 x 85 x 60 mm (0.7"x 3.35"x 2.4")	17.5 x 85 x 60 mm (0.7"x 3.35"x 2.4")	35 x 62.5 x 57 mm (1.4"x 2.7"x 2.24")	35 x 85 x 60 mm (1.4"x 3.35"x 2.4")	53.3 x 84 x 60 mm (2.1"x 3.31"x 2.4")	53.3 x 84 x 60 mm (2.1"x 3.31"x 2.4")
Standards:	IEC 60947-4-1, IEC 60947-5-1, IEC 61095, EN 60947-4-1, EN 60947-5-1, EN 61095, VDE 0660					

* 3.8 VA/3.8 W for -04 version of contacts

** Note: In case several contactors are mounted close to each other, you need to use an installation spacer between every other contactor.

VS120



VS220

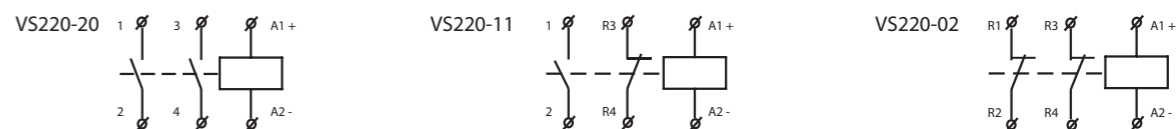

VS420



VS425

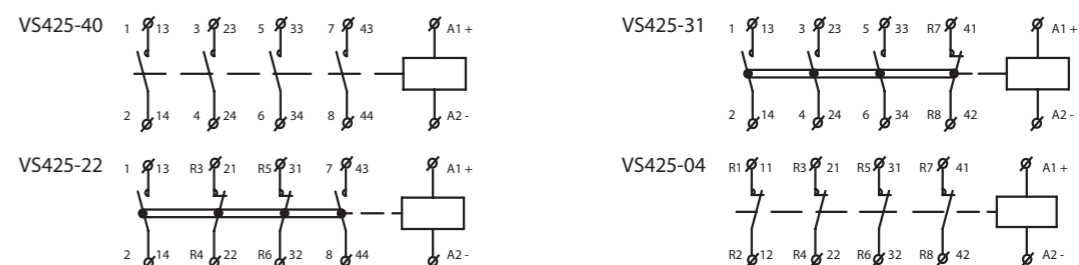

VS440

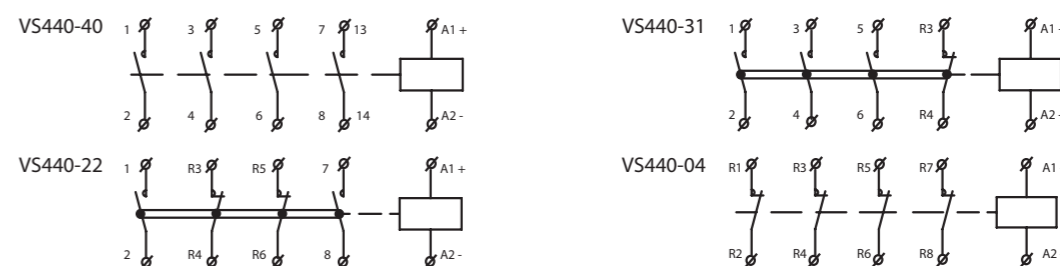

VS463

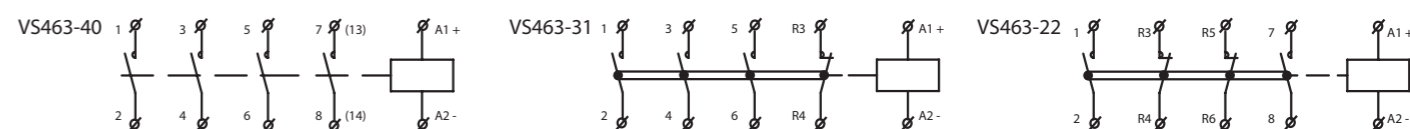

Auxiliary contacts for VS425, VS440, VS463 and VSM220, VSM425

Datas of auxiliary contacts for VSK-11 and VSK-20

Ambient temperature:	-5 °C to +55 °C (23 °F to 131 °F)
Rated insulation voltage (Ui):	500 V
Electrical strength:	4 kV
Rated current 230 V (AC 15):	6 A
Rated current 400 V (AC 15):	4 A
Max. switching frequency:	6 A
The max. number of switching for max. load:	600 sep./hod.
Minimal load:	≥ 12 V, ≥ 10 mA
Short circuit protection with the fuse char. aM:	6 A
Solid/ Stranded conductor (max):	2.5 mm ² / 2.5 mm ² (AWG 10)
Maximal torque:	0.8 Nm
Weight:	10 g (0.35 oz.)
Dimensions:	10 x 85 x 60 mm (0.4"x 3.35"x 2.4")

Connection of auxiliary contact VSK-11 and VSK-20

EAN code see page 154

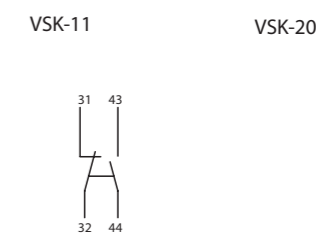

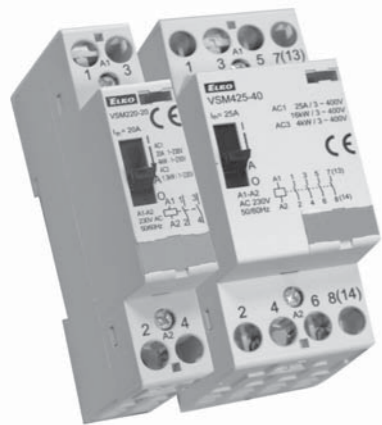

EAN code see page 154

Technical parameters	VSM220	VSM425
Rated insulation voltage (Ui):	230 V	440 V
Rated thermo-current I _m (in AC):	20 A	25 A
Switched operation		
AC-1 for 400 V:	x	16 kW, 3 phase
AC-1 for 230 V:	4 kW, 1 phase	9 kW, 3 phase
AC-3 for 400 V:	x	4 kW, 3 phase
AC-3 for 230 V:	1.3 kW only NO, 1 phase	2.2 kW, 3 phase
AC-7a for 400 V:	x	16 kW, 3 phase
AC-7a for 230 V:	4 kW, 1 phase	9 kW, 3 phase
AC-7b for 400 V:	x	4 kW, 3 phase
AC-7b for 230 V:	1.3 kW only NO, 1 phase	2.2 kW, 3 phase
AC-15 for 400 V:	4 A	4 A
AC-15 for 230 V:	6 A	6 A
DC1 U _e = 24 V:	20 A	25 A
DC1 U _e = 110 V:	6 A	6 A
DC1 U _e = 220 V:	0.6 A	0.6 A

Loadability of modular contactors see page 153
 The max. number of switching for max. load: 600 switch/hr. 600 switch/hr.

Electrical life in 230 / 400 V		
AC-1- resistive load:	0.2x10 ⁶	0.2x10 ⁶
AC-3-power load:	0.3x10 ⁶	0.5x10 ⁶
AC-5a - high-intensity discharge lamp:	0.1x10 ⁶ by 30 µF	0.1x10 ⁶ by 36 µF
AC-5b - incandescent lamps:	0.1 10 ⁶ by 1.5 kW	0.1x10 ⁶ by 1.5 kW
AC-7a - resistive household devices:	0.2x10 ⁶	0.2x10 ⁶
AC-7b - inductive household devices:	0.3x10 ⁶	0.5x10 ⁶
Minimal load:	≥ 17 V, ≥ 50 mA	≥ 17 V, ≥ 50 mA
Short circuit protection with the fuse char. aM:	20 A	25 A
Coordination Type according EN 60 947-4-1:	2	2
Electrical strenght:	4 kV	4 kV

Contacts - max. cable size		
Solid conductor:	AWG 7 (10 mm ²)	AWG 7 (10 mm ²)
Stranded conductor:	6 mm ²	6 mm ²
Maximal torque:	1.2 Nm	1.2 Nm

Coil - max. cable size		
Solid conductor:	AWG 10 (2.5 mm ²)	AWG 10 (2.5 mm ²)
Stranded conductor:	2.5 mm ²	2.5 mm ²
Max. torque:	0.6 Nm	0.6 Nm

Operating		
Coil control voltage:	AC 12 V, 24 V, 110 V, 230 V	AC 12 V, 24 V, 42 V, 230 V
Coil permanent supply +/- 10 %:	2.8 VA/1.2 W	5.5 VA/1.6 W
Coil gear supply +/- 10 %:	12 VA /10 W	33 VA/25 W
Mounting side-by-side:	max. 2 contactors*	max. 2 contactors*
Operational temperature:	-5 ... +55 °C (23... 131 °F)	
Storing temperature:	-30... +80 °C (-22... 176 °F)	
Weight:	140 g (4.9 oz.)	260 g (9.17 oz.)
Dimensions:	17.5 x 85 x 60 mm (0.7" x 3.35" x 2.4")	35 x 85 x 60 mm (1.4" x 3.35" x 2.4")
Standards:	IEC 60947-4-1, IEC 60947-5-1, IEC 61095, EN 60947-4-1, EN 61095, VDE 0660	

- Special version of installation contactors with not only basic functions but also with manual control.
- For switching accumulative appliances for heating and service water warming.
- Description of individual positions of manual control.
 - AUTO: common function as with installation contactors without manual control.
 - 1: shifting from AUTO to 1: operational contacts are closed and back contacts are open until there is another impulse to a contactor coil.
 - 0: contacts are open (operational contact) or closed (stand-by contact) regardless voltage.
- Optical indicator: ON-OFF.
- It is produced in configuration of making and breaking contacts: VSM220: 20, 11, 02 VSM425: 40, 31, 22, 04
- It is possible to connect auxiliary contacts VSK to contactors VSM220, VSM425.

Connection VSM220 VSM220 - only AC supply voltage

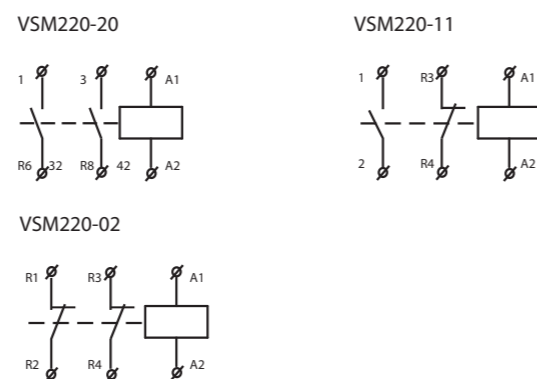

Connection VSM425 VSM425 - only AC supply voltage

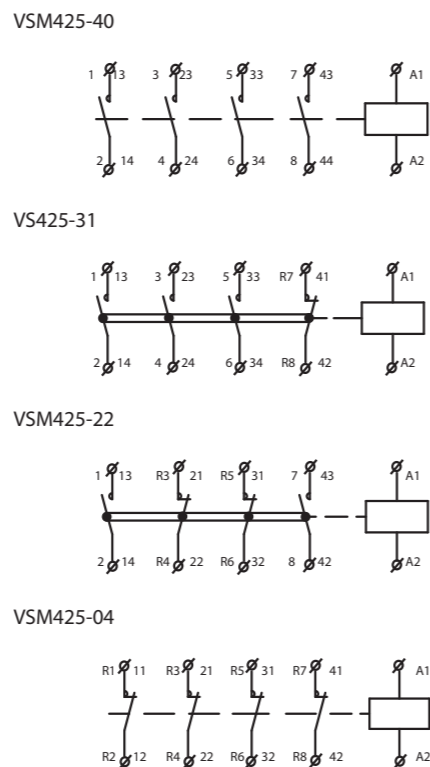

Auxiliary contacts VSK-11 and VSK-20

Datas of auxiliary contacts for VSK-11 and VSK-20 see page 151.

* Note: In case several contactors are mounted close to each other, you need to use a installation spacer between every other contactor.

TYPE OF LIGHT	OPERATION (W)	I (A)	Number of lights on one contactor's contact							
			VS120	VS220	VS420	VS425	VS440	VS463	VSM220	VSM425
Incandescent lamps	60	0.26	33	33	33	33	65	85	33	33
	100	0.43	20	20	20	20	40	50	20	20
	200	0.87	10	10	10	10	20	25	10	10
	500	2.17	3	3	3	3	8	10	3	3
	1000	4.35	1	1	1	1	4	5	1	1
Flourescent lamps	18	0.37	22	22	22	24	90	140	22	24
	24	0.35	22	22	22	24	90	140	22	24
	36	0.43	17	17	17	20	65	95	17	20
	58	0.67	14	14	14	17	45	70	14	17
Flourescent lamps lead-lag circuit	18	0.11	2 x 30	2 x 30	2 x 30	2 x 40	2 x 100	2 x 150	2 x 30	2 x 40
	24	0.14	2 x 24	2 x 24	2 x 24	2 x 31	2 x 78	2 x 118	2 x 24	2 x 31
	36	0.22	2 x 17	2 x 17	2 x 17	2 x 24	2 x 65	2 x 95	2 x 17	2 x 24
	58	0.35	2 x 10	2 x 10	2 x 10	2 x 14	2 x 40	2 x 60	2 x 10	2 x 14
Flourescent lamps parallel correction	18	0.12	7	7	7	8	48	73	7	8
	24	0.15	7	7	7	8	48	73	7	8
	36	0.2	7	7	7	8	48	73	7	8
	58	0.32	4	4	4	5	31	47	4	5
Flourescent lamps with electronic ballast units (EVG)	1 x 18	0.09	25	25	25	35	100	140	25	35
	1 x 36	0.16	15	15	15	20	52	75	15	20
	1 x 58	0.25	14	14	14	19	50	72	14	19
	2 x 18	0.17	12	12	12	17	50	70	12	17
	2 x 36	0.32	7	7	7	10	26	38	7	10
	2 x 58	0.49	7	7	7	9	25	36	7	9
High-pressure mercury-vapour lamps uncorrected	50	0.61	14	14	14	18	38	55	14	18
	80	0.8	10	10	10	13	29	42	10	13
	125	1.15	7	7	7	9	20	29	7	9
	250	2.15	4	4	4	5	10	15	4	5
	400	3.25	2	2	2	3	7	10	2	3
	700	5.4	1	1	1	2	4	6	1	2
High-pressure mercury-vapour lamps parallel correction	1000	7.5	1	1	1	1	3	4	1	1
	50	0.28	4	4	4	5	31	47	4	5
	80	0.41	4	4	4	5	27	41	4	5
	125	0.65	3	3	3	4	22	33	3	4
	250	1.22	1	1	1	2	12	18	1	2
	400	1.95	1	1	1	1	9	13	1	1
Halogen metal vapour lamps uncorrected	700	3.45	-	-	-	-	5	7	-	-
	1000	4.8	-	-	-	-	4	5	-	-
	35	0.53	18	18	18	22	43	60	18	22
	70	1	10	10	10	12	23	32	10	12
	150	1.8	5	5	5	7	12	18	5	7
	250	3	3	3	3	4	7	10	3	4
Halogen metal-vapour lamps parallel correction	400	3.5	3	3	3	3	6	9	3	3
	1000	9.5	1	1	1	1	2	3	1	1
	2000	16.5	-	-	-	-	1	1	-	-
	35	0.25	5	5	5	6	36	50	5	6
	70	0.45	2	2	2	3	18	25	2	3
	150	0.75	1	1	1	1	11	15	1	1
High-pressure sodium-vapour lamps uncorrected	250	1.5	-	-	-	1	6	9	-	1
	400	2.5	-	-	-	1	6	8	-	1
	1000	5.8	-	-	-	-	2	3	-	-
	2000	11.5	-	-	-	-	1	2	-	-
	150	1.8	5	5	5	6	17	22	5	6
	250	3	3	3	3	4	10	13	3	4
High-pressure sodium-vapour lamps parallel correction	400	4.7	2	2	2	2	6	8	2	2
	1000	10.3	-	-	-	1	3	3	-	1
	150	0.83	1	1	1	1	11	16	1	1
	250	1.5	-	-	-	1	6	10	-	1
Low-pressure sodium-vapour lamps uncorrected	400	2.4	-	-	-	-	4	6	-	-
	1000	6.3	-	-	-	-	2	3	-	-
	18	0.35	22	22	22	27	71	90	22	27
	35	1.5	7	7	7	9	23	30	7	9
	55	1.5	7	7	7	9	23	30	7	9
	90	2.4	4	4	4	5	14	19	4	5
Low-pressure sodium-vapour lamps parallel correction	135	3.5	3	3	3	4	10	13	3	4
	180	3.3	3	3	3	4	10	13	3	4
	18	0.35	6	6	6	7	44	66	6	7
	35	0.31	1	1	1	1	11	16	1	1
	55	0.42	1	1	1	1	11	16	1	1
	90	0.63	1	1	1	1	8	12	1	1
Low-pressure sodium-vapour lamps parallel correction	135	0.94	-	-	-	-	4	7	-	-
	180	1.16	-	-	-	-	5	8	-	-

EAN codes for VS

VS120

VS120-01 24V AC/DC: 8595188129848
 VS120-01 230V AC/DC: 8595188123105

VS120-10 24V AC/DC: 8595188129367
 VS120-10 230V AC/DC: 8595188123112

VS425

VS425-04 24V AC/DC: 8595188129527
 VS425-04 48V AC/DC: 8595188129558
 VS425-04 110V AC/DC: 8595188160032
 VS425-04 230V AC/DC: 8595188121682

VS425-13 230V AC/DC: 8595188129473

VS425-22 24V AC/DC: 8595188129541
 VS425-22 230V AC/DC: 8595188121675

VS425-31 24V AC/DC: 8595188129497
 VS425-31 48V AC/DC: 8595188137898
 VS425-31 110V AC/DC: 8595188129534
 VS425-31 230V AC/DC: 8595188121668

VS425-40 24V AC/DC: 8595188129480
 VS425-40 48V AC/DC: 8595188136174
 VS425-40 230V AC/DC: 8595188121651

VS220

VS220-02 24V AC/DC: 8595188129381
 VS220-02 110V AC/DC: 8595188138628
 VS220-02 230V AC/DC: 8595188121422

VS220-11 24V AC/DC: 8595188129374
 VS220-11 48V AC/DC: 8595188129398
 VS220-11 110V AC/DC: 8595188130790
 VS220-11 230V AC/DC: 8595188121408

VS220-20 24V AC/DC: 8595188125253
 VS220-20 48V AC/DC: 8595188129411
 VS220-20 110V AC/DC: 8595188129428
 VS220-20 230V AC/DC: 8595188121392

VS440

VS440-04 24V AC/DC: 8595188129299
 VS440-04 110V AC/DC: 8595188129305
 VS440-04 230V AC/DC: 8595188121484

VS440-22 24V AC/DC: 8595188129787
 VS440-22 230V AC/DC: 8595188121477

VS440-31 24V AC/DC: 8595188129572
 VS440-31 230V AC/DC: 8595188121460

VS440-40 24V AC/DC: 8595188129565
 VS440-40 110V AC/DC: 8595188138567
 VS440-40 230V AC/DC: 8595188121453

VS420

VS420-31 24V AC: 8595188129442
 VS420-31 110V AC: 8595188129466
 VS420-31 230V AC: 8595188121446

VS420-40 12V AC: 8595188129459
 VS420-40 24V AC: 8595188129435
 VS420-40 48V AC: 8595188138581
 VS420-40 230V AC: 8595188121439

VS463

VS463-22 24V AC/DC: 8595188129794
 VS463-22 230V AC/DC: 8595188121514

VS463-31 24V AC/DC: 8595188129596
 VS463-31 110V AC/DC: 8595188137904
 VS463-31 230V AC/DC: 8595188121507

VS463-40 24V AC/DC: 8595188129589
 VS463-40-48V AC/DC: 8595188160612
 VS463-40 110V AC/DC: 8595188140652
 VS463-40 230V AC/DC: 8595188121491

EAN codes for VSM

VSM220

VSM220-02 24V AC: 8595188129817
 VSM220-02 230V AC: 8595188128100

VSM220-11 24V AC: 8595188129800
 VSM220-11 230V AC: 8595188128094

VSM220-20 12V AC: 8595188138369
 VSM220-20 24V AC: 8595188128117
 VSM220-20 110V AC: 8595188160223
 VSM220-20 230V AC: 8595188128087

VSM425

VSM425-04 24V AC: 8595188129831
 VSM425-04 230V AC: 8595188128155

VSM425-22 24V AC: 8595188129336
 VSM425-22 230V AC: 8595188128148

VSM425-31 24V AC: 8595188129824
 VSM425-31 230V AC: 8595188128131

VSM425-40 12V AC: 8595188160049
 VSM425-40 24V AC: 8595188128162
 VSM425-40 230V AC: 8595188128124

EAN codes for VSK

VSK-11: 8595188121613

VSK-20: 8595188121606

Main regulations for correct use of products	156
Product loadability	157
Electro-magnetic compatibility of products	159
EMC chart	160
Overview of tested types of light sources and the loads	161
Products packing	162
Dimensions	163
Examples of usage	170

To ensure correct and perfect function of a device and its safe operation, it is necessary to ensure and observe several main regulations:

- 1. Device supply**
 - it is necessary to ensure continuous supply of the device without drops and voltage peaks. It is mainly important for device (e.g. dimmers) where there is synchronization managed by sine wave of the main and fault in the main ca cause unreliable function of the device
 - it is necessary to observe correct connection of terminals, and in case of DC supply voltage also polarity
 - it is necessary to observe allowed tolerance of the size of supply voltage which is given by technical parameters of individual devices

- 2. Protection of the device**
 - it is necessary to ensure protection of the device by adequate elements of overvoltage protection – by fuses, by surge arrestors

- 3. Elimination of disturbances on input circuits**
 - it is recommended to eliminate disturbances on control inputs of devices by suitable elements (R-C elements) and thus minimize creation of inductive voltage on incoming wires
 - pay attention when connecting control inputs and keep in mind max. current and min. voltage at rest, which can cause spontaneous switching of device (e.g. connected glow lamps)

- 4. Operating conditions**
 - to assure the granted life and correct functions of device, there is not recommended to leave the device in extreme conditions that could negative way influence the correct device functions - permanent temperature influence over 70°C, aggressive exhalations, chemicals, high relative humidity over 95%, high electromagnetic field or microwave radiation
 - for error-free function it is necessary to avoid device placement close to electromagnetic interference source
 - all mentioned products fulfill the EMC requirements in accordance with EU Directive 89/336/EEC. Notwithstanding it is necessary to pay attention when devices are connected to circuit with electrical appliances that produce electromagnetic interference (contactors, motors), and pay attention to close power cables. It is recommended that device connecting cables (supply and control inputs) are possibly short and go separately from power cables. In case the device is connected to circuit with contactors or motors, it is necessary to protect the device with appropriate extern protection components - RC members, varistors or surge voltage protector.
 - when you use AL wires, it is necessary to follow requirements of ČSN standard 370606: 1959 and ČSN 370606 amendment 2: 1992

- 5. Device handling and using**
 - input terminals do not fill-in with high power (for serial terminals max 0.5 N/m), do not give excessive pressure to carrier terminal parts to avoid damage of inner device construction
 - protect the device before falls and excessive vibrations that could damage relays contacts
 - do not overload input relay's contacts, especially when using loads with other category then AC1
 - when at switching of big loads the relay contacts get sealed it is necessary to use inserted contactor or power relay tuned to required load for given application

Description of used protection elements in device

All time and monitoring relays from our assortment are equipped with protective elements (varistors) against possible overvoltage in supply main. Limit voltage of used varistors is 275 V. At short-time overvoltage in supply main varistor decrease its leak resistor and accumulate arisen overvoltage. When this overvoltage behave as short-time peak, varistor is able to react and protect the device against negative influences. As other protection elements there are used transils and zener diodes that eliminate overvoltage impulses in supply and input circuits of device (e.g. when switching inductive loads). In case of switching inductive loads it is recommended to separate a supply of power element (motors, contactors etc.) from supply of measuring and control device inputs.

On the charts bellow you can see oscilographic running of disconnecting of loads (contactors) and reaction of protective elements to arisen voltage pikes.

Process of disconnection of contactor with coil on 230V/AC without R-C member

Process of disconnection of contactor with coil on 230V/AC and R-C member 390 Ohm-330 nF

Process of disconnection of contactor with coil and limited varistor on 230V/AC

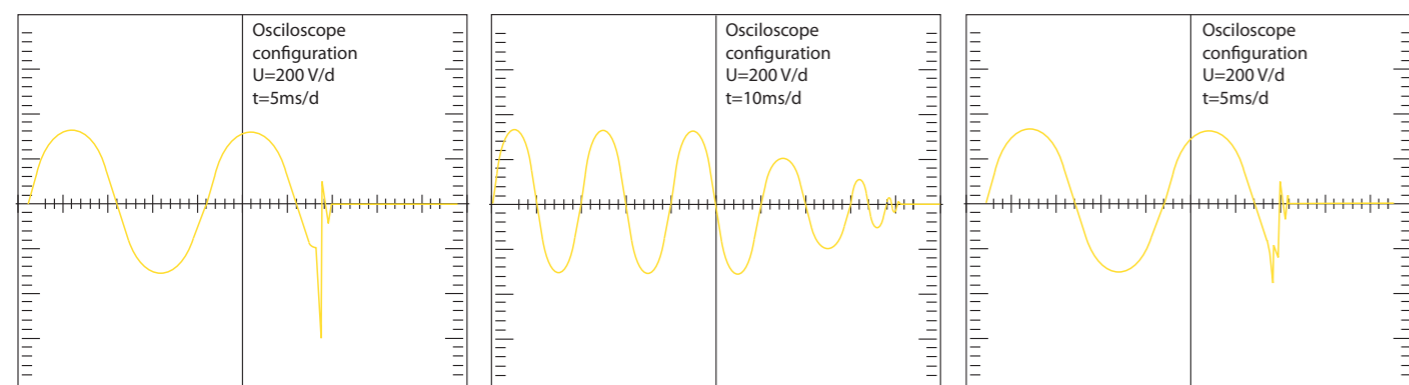

PRODUCT	SOU-2	RHV-1; SOU-3; TEV-4	CRM-4; CRM-42; HRH-7; MR-41; MR-42; SHT-1; SHT-1/2; SHT-3; SHT-3/2; SHT-4; SHT-6; SMR-B; SOU-1; RHT-1; TER-3A; TER-3B; TER-3C; TER-3D; TER-3E; TER-3F; TER-3G; TER-3H; VS116B/230; VS116K; VS116U; VS316/24V; VS316/230V	CRM-82TO; CRM-83J; CRM-93H; PRM-2H; PRM-92H; TER-7; VS308K; VS308U; CRM-61; HRH-5; HRN-54; HRN-54N; HRN-55; HRN-55N; HRN-56; HRN-57; HRN-57N; PRI-32; PRI-51; PRI-52; PRI-53; HRF-10; TER-9	HRH-6	ATC; ATF; ATR; DTC; DTF; DTR; COS-2; CRM-2H; CRM-2HE; CRM-2T; CRM-81J; CRM-91H; CRM-91HE; HRH-1; HRN-33; HRN-34; HRN-35; HRN-37; HRN-41; HRN-42; HRN-43; HRN-43N; HRN-63; HRN-64; HRN-67; PDR-2; PRI-41; PRI-42; PRM-91H; SJR-2; TER-4; TEV-1; TEV-2; TEV-3
CONTACT	Material of contact AgSnO ₂ contact 8A	Material of contact AgSnO ₂ contact 12A	Material of contact AgSnO ₂ contact 16A	Material of contact AgNi contact 8A	Material of contact AgNi contact 10A	Material of contact AgNi contact 16A
TYPE OF LOAD						
AC1	250V / 8A	250V / 12A	250V / 16A	250V / 8A	250V / 10A	250V / 16A
AC2	250V / 5A	250V / 3.7A	250V / 5A	250V / 3A	250V / 3A	250V / 5A
AC3	250V / 4A	250V / 2.2A	250V / 3A	250V / 2A	250V / 2A	250V / 3A
AC5a uncompensated	x	230V / 2.2A (510VA)	230V / 3A (690VA)	230V / 1.5A (345VA)	230V / 2A (460VA)	230V / 3A (690VA)
AC5a compensated	x	230V / 2.2A (510VA) till max output C=14UF	230V / 3A (690VA) till max output C=14UF	x	x	x
AC5b	250W	1 120W	1000W	300W	500W	800W
AC6a	250V / 4A	x	x	x	x	x
AC7b	250V / 1A	250V / 2.2A	250V / 3A	250V / 1A	250V / 2A	250V / 3A
AC12	250V / 1A	250V / 7.5A	x	250V / 1A	250V / 6A	250V / 10A
AC13	x	250V / 4.5A	x	x	250V / 3.8A	250V / 6A
AC14	250V / 4A	250V / 4.5A	250V / 6A	250V / 3A	250V / 3.8A	250V / 6A
AC15	250V / 3A	250V / 4.5A	250V / 6A	250V / 3A	250V / 3.8A	250V / 6A
DC1	30V / 8A	24V / 12A	24V / 10A	24V / 8A	24V / 10A	24V / 16A
DC3	30V / 3A	24V / 4.5A	24V / 3A	24V / 3A	24V / 3.8A	24V / 6A
DC5	30V / 2A	24V / 3A	24V / 2A	24V / 2A	24V / 2.5A	24V / 4A
DC12	30V / 8A	24V / 12A	24V / 6A	24V / 8A	24V / 10A	24V / 16A
DC13	30V / 2A	24V / 1.5A	24V / 2A	24V / 2A	24V / 1.3A	24V / 2A
DC14	x	24V / 1.5A	x	x	24V / 1.3A	24V / 2A

Problematic choice of suitable relay contact for a particular load switched with a product is described below. Mostly we experience problems with incorrect choice of load (meaning incorrect relay for a particular load) which results in permanent switching of contact (sealing) or damage on relay contact – which then results in malfunction. What load can you use? Detailed types of load according to standard EN 60947 are described in charts below – categories of use.

Category of use	Typical use	EN
AC current, $\cos\phi = P/S (-)$		
AC-1	Non-inductive or slightly inductive load, resistance furnace Includes all appliances supplied by AC current with power factor ($\cos\phi$) ≥ 0.95 Examples of usage: resistance furnace, industrial loads	60947-4
AC-2	Motors with slip-ring armature, switching off	60947
AC-3	Motors with short-circuit armature, motor switching when in operation This category applies to switching off motors with short-circuit armature while in operation. While switching, contactor switches current which is 5 up to 7 times rated current of motor.	60947-4
AC-4	Electro-motors with short-circuit armature: start up, braking by backset, changeover	60947
AC-5a	Switching of electrical gas-filled lights, fluorescent lights	60947-4
AC-5b	El. bulb switching Enables low contact loading due to resistance of cold fiber is many times smaller than the one of hot fiber.	60947-4
AC-6a	Switching of transformers	60947-4
AC-6b	Switching of capacitors	60947-4
AC-7a	Switching low inductive loads of home appliances and similar applications	60947
AC-7b	Load of motors for home appliances	60947
AC-8a	Switching of hermetically sealed motors of cooling compressors with manual reset switches against overload Hermetically sealed cooling compressors have to be placed in one box without external shaft or shaft padding and motor must operate with cooling liquid	60947
AC-8b	Switching of hermetically sealed motors of cooling compressors with manual reset switches against overload Hermetically sealed cooling compressors have to be placed in one box without external shaft or shaft padding and motor must operate with cooling liquid	60947
AC-12	Switching of semiconductor loads with separation transformers	60947-5
AC-13	Switching of semiconductor loads with separation transformers	60947-5-1
AC-14	Switching of low electro-magnetic loads (max.72 VA)	60947-5-1
AC-15	Management of alternating electro-magnetic loads This category applies to switching inductive loads with input for closed electro-magnetic circuit higher than 72 VA Use: switching coils of contactors	60947-5
AC-20	Connecting and disconnecting in unloaded states	60947-3
AC-21	Switching resistive loads, including low loading	60947-3
AC-22	Switching of mixed resistive and inductive loads, including low overloading	60947-3
AC-23	Switching of motor loads or other high inductive loads	60947-3
AC-53a	Switching of motors with short-circuit armature with semiconductor contactors	60947

Note: Category AC 15 replaces formerly used category AC 11

DC current, $t = L/R (s)$

DC-1	Non-inductive or low inductive load, resistive furnaces	60947-4
DC-3	Shunt motors: start-up, braking by backset, reversion, resistive braking	60947-4-1
DC-5	Series motor: start-up, braking by backset, reversion, resistive braking	60947-4-1
DC-6	Non-inductive or low inductive loads, resistive furnaces – el. bulbs	60947-4-1
DC-12	Management of resistive loads and fixed loads with insulation by opto-electric element	60947-5-1
DC-13	Switching of electromagnets	60947-5-1
DC-14	Switching of electromagnetic loads in circuits with limiting resistor	60947-5-1
DC-20a(b)	Switching and breaking without load(a: frequent switching ,b: occasional switching)	60947-3
DC-21a(b)	Switching ohmic loads including limiting overloading (a: frequent switching ,b: occasional switching)	60947-3
DC-22a(b)	Switching of compound ohmic and inductive loads including limited overloads (e.g. shunt motors) (a: frequent switching, b: random switching)	60947-3
DC-23	Switching of highly inductive loads (e.g. series motors)	60947-3

How can you distinguish for which load is our product (relay) designated?

Our company record this information on a products and also in our catalogue, instruction manual and other promotional and technical material (website etc.). It is important to realize that it is not always possible to point out load because of lack of information about the device (user cannot measure $\cos\phi$) or it is not possible because of inconstancy of parameters of switched device. Manufacturer of relays records always guaranteed parameters in ideal conditions which are done by a norm (temperature, pressure, humidity, etc.) and reality can be in a lot of cases different. Category of use (classification) of a particular relay is done by material of output contacts.

Basic types of materials which are used for production of contacts for high-performance relay are:

- AgCd – suitable for switching ohmic loads. Before of harmfulness of Cd, this type of contact is remitted.
- AgNi – designated for switching resistive loads, good quality switching and conducting (contact doesn't oxidate) small currents/voltages, it is not designated for surge currents and loads with inductive component.
- AgSn or AgSnO₂ – suitable for switching loads with inductive component, not suitable for switching small currents/voltages, it is more resistive to surge currents, suitable for DC voltage switching, less suitable for switching loads of ohmic type.
- Wf (wolfram)-special contact designated for switching surge currents with inductive component.
- with gold (AgNi/Au)- Used for "improving" contacts for low currents/ voltages , prevents oxidation.

Electromagnetic compatibility (EMC) is a new scientific field which was founded in the 60s last century. It had been known only to a small number of specialists working in a military and cosmic research.

Electromagnetic compatibility EMC is defined as an ability of a device, system or a machine to show the correct operation even in an environment in which there are other sources of electromagnetic signals (natural or artificial), and also an ability not to influence negatively the environment by its own "electromagnetic action" and not to radiate signals that would disturb other devices. It is an indicator of good quality and reliability. Breach of such EMC requirements may cause several damages with catastrophic consequences.

When testing EMC of a device or system (technical and biological), it is based on so called "fundamental chain of EMC" shown in the picture. This chain shows a system problematic of EMC and we inspect all three components.

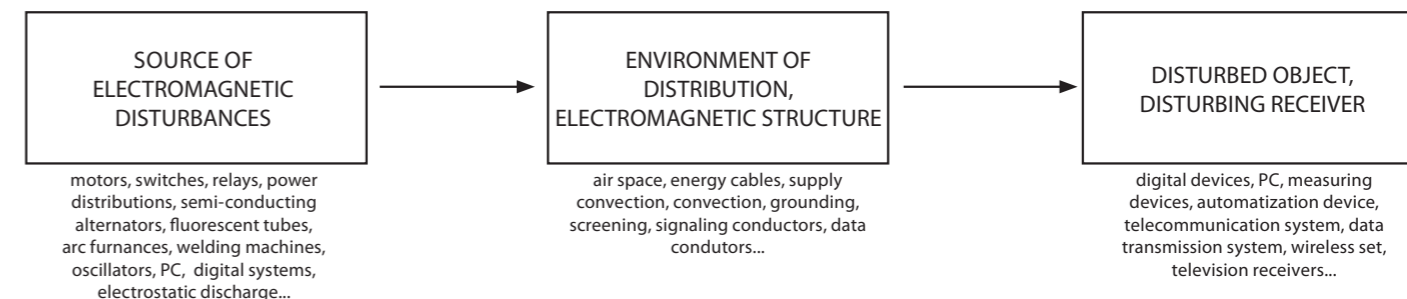
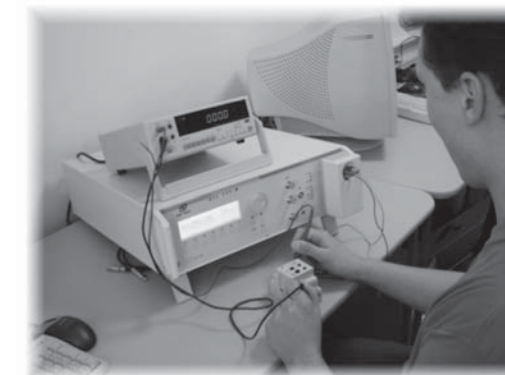

Test SURGE

For guarantee the immunity of our devices against to electromagnetic disturbance we are doing EMC tests and according results we are still innovating our product to be according the EMC norms with reserve.

The most important test is immunity against gust of high-energy voltage and current impulse (SURGE), what is made according the norm IEC 61000-4-5.

By this our products are controlled in case of short time pulse, what is applied as to input as to output circuits of devices, to switching inputs, sensing inputs, etc. Our products pass all criterias and are fully competitive to foreign products.

Test SURGE is used in practice mainly for 1-phase devices with take-off current to 16 A. It makes use of voltage impulse 1,2/50 ms no load and current impulse 8/20 ms for short time. Size of used voltage impulse is 0.5 kV, 1 kV, 2 kV and 4 kV, size of used current impulse is 2kA on 4kV with choice of changing polarity. For testing by impulses is as coup mode specify capacitive coupling.

Test BURST

Other very important test is test immunity against quick short-lived effect (couple of impulses- BURST), which dissimulated influence if industry disturbance. Test is made according to the norm IEC 61000-4-4.

Disturbance signal is injected to supply circuits and communication cabling. Coupling is made by 1-phase capacitive circuit or coupling capacitive ribband to supply, signalling or data convection of tested device. Size of testing impulses is 0.5 kV, 1 kV, 2 kV and 4 kV in positive and negative polarity. Repeat frequency is 2.5 kHz, or 5 kHz. Period of testing 0 - 6 minut by steps for 0.1s.

Test POWERFAIL

For right function of products in industry is important POWERFAIL test - simulation of decreasing and failure of supply voltage. It is made according to the IEC 61000-4-11.

Short-time supply decreasing are random decreasing of supply voltage, which are more than 10 - 15 % of its nominal size and have short time existing 0.5 - 50 perodes of basic frequency 50 Hz.

Short breaks of voltage are short time decreasing over 100 %. Mentioned changes of supply circuit voltage are made in practise by disturbance in mains (high voltage, low voltage) and breaks on load of the main.

Test of EMC emissions

Electronic devices must be designed not to be a source of oversize electric or electromagnetic disturbances in its surroundings. Test is executed according to standard EN 55022. Emissions are measured by wires or by air.

Test of electromagnetic high-frequency field and HF signal coming from the main

The purpose of this test is to verify immunity of the device against electromagnetic fields that are created by radio transmitters or by any other device which transmits electromagnetic energy by uninterrupted waves (walkie-talkies, radio and TV transmitters.)

Test is carried out against disturbances in the main and emissions. We apply testing level 3 which for HF field means intensity of field 10 V/m and for HF signal it is voltage level 10 V.

Test of electrostatic discharge

It is a test of resistance against discharges of electrostatic energy caused by servicing or by surrounding objects. Such discharge can damage a device or its components.

Test is carried out by direct or indirect application of discharges to a tested device. Test is carried out according to a standard EN 61000-4-2. Direct influence of discharges is targeted into such places and surfaces that are accessible to servicing during common use. Indirect influence of discharge is done by horizontal and vertical coupling board.

The device is treated by at least ten individual discharges for positive and negative polarity. Testing levels are 2kV, 4kV, 6kV, 8kV, 15kV.

Company ELKO EP has its own test laboratory in which it carries out pre-certification for conditions that must be met by each of our products. Thus customers gets not only a product of a high quality, which is ensured by many years of experience in the field of switching relays, but also a product which can operate in demanding conditions of industrial environment. Product, tested this way, guarantees reliability and functionality to customer's full satisfaction.

PRODUCT	STANDARD		
	levels according to CSN EN 61000-4-4	levels according to CSN EN 61000-4-5	EMC; EMI/SE according to norm:CSN EN
Time relays			
CRM-81J/230V	3	3	55022/A
CRM-81J/UNI	3	3	55022/A
CRM-83J/230V	3	3	55022/A
CRM-83J/UNI	3	3	55022/A
CRM-82TO	3	3	55022/A
SJR-2/230V	3	3	55022/B
SJR-2/UNI	3	3	55022/A
CRM-2T/230V	3	3	55022/B
CRM-2T/UNI	3	3	55022/A
CRM-2H/230V	3	3	55022/A
CRM-2H/UNI	3	3	55022/A
CRM-91HE/UNI	3	3	55022/A
CRM-2HE/UNI	3	3	55022/A
CRM-91H/230V	3	3	55022/B
CRM-91H/UNI	3	3	55022/A
CRM-93H/230V	3	3	55022/B
CRM-93H/UNI	3	3	55022/A
CRM-95	-	3	61000-6-3
CRM-61	3	2	61000-6-3
SHT-1	3	3	55022/A
SHT-1/2	3	3	55022/A
SHT-3	3	3	55022/A
SHT-3/2	3	3	55022/A
PDR-2A/230V	2	3	61000-6-3
PDR-2A/UNI	3	3	61000-6-3
PDR-2B/230V	2	3	61000-6-3
PDR-2B/UNI	3	3	61000-6-3
PRM-91H/8	3	3	55022/B
PRM-91H/11	3	3	55022/B
PRM-92H	2	3	55022/A
PRM-2H	2	3	55022/A
SMR-T	2	2	61000-6-3
SMR-H	2	2	55022/A
SMR-B	2	2	61000-6-3
CRM-4	3	3	55022/B
CRM-42	3	3	55022/A
Power and auxiliary relays			
VS116K	3	3	55022/A
VS116U	3	2	55022/A
VS308K/230V	3	3	61000-6-3
VS308K/UNI	3	2	55022/B
VS308U	3	2	55022/A
VS316/24V	3	-	-
VS316/230V	3	3	55022/B
Dimmers			
DIM-2	2	2	61000-6-3
DIM-5	2	2	61000-6-3
DIM-14	2	2	55022/B
DIM-6	2	2	55014-1
DIM6-3M-P	2	2	55014-1
DIM-15	2	2	55014-1
SMR-S	2	2	55022/A
SMR-U	2	2	55022/B
LIC-1	2	2	550015

PRODUCT	STANDARD		
	levels according to CSN EN 61000-4-4	levels according to CSN EN 61000-4-5	EMC; EMI/SE according to norm:CSN EN
Power supplies			
PS-10-12; PS-10-24	3	3	55022/B
PS-30-12; PS-30-24	3	3	55022/B
PS-100-12; PS-100-24	3	3	55022/B
PS-30R	3	3	55022/A/B
ZSR-30	3	3	61000-6-3
ZNP-10-12V	-	3	55022/B
ZNP-10-24V	-	3	55022/B
Other modular devices			
SOU-1/230V	3	3	61000-6-3
SOU-1/UNI	3	2	55022/A
SOU-2	3	3	61000-6-3
SOU-3	3	3	55022/B
MR-41/230V	3	3	55022/A
MR-41/UNI	3	3	55022/A
MR-42/230V	3	3	55022/A
MR-42/UNI	3	3	55022/A
Monitoring relays			
HRN-41	3	3	61000-6-3
HRN-42	3	3	61000-6-3
HRN-33	3	3	55022/A
HRN-34	3	-	-
HRN-35	3	3	55022/A
HRN-37	3	3	55022/A
HRN-63	3	3	55022/A
HRN-64	3	-	-
HRN-67	-	-	-
HRN-55	3	3	55022/B
HRN-55N	3	3	55022/B
HRN-57	3	3	55022/B
HRN-57N	3	3	55022/B
HRN-54	3	3	55022/B
HRN-54N	3	3	55022/B
HRN-56/120	3	3	55022/B
HRN-56/208	3	3	55022/B
HRN-56/240	3	3	55022/B
HRN-56/400	3	3	55022/B
HRN-56/480	3	3	55022/A
HRN-56/575	3	3	55022/A
HRN-43	3	3	55022/A
HRN-43N	3	3	55022/A
PRI-32	3	3	61000-6-3
PRI-51/1	3	3	61000-6-3
PRI-51/2	3	3	61000-6-3
PRI-51/5	3	3	61000-6-3
PRI-51/8	3	3	61000-6-3
PRI-51/16	3	3	61000-6-3
PRI-51/0.5	3	-	-
PRI-52	3	3	55022/A
PRI-41	3	3	61000-6-3
PRI-42	3	3	61000-6-3
HRH-1/230V	3	3	55022/A
HRH-1/24V	3	3	55022/A
HRH-1/110V	3	3	55022/A
HRH-5	3	3	61000-6-3

PRODUCT	STANDARD		
	levels according to CSN EN 61000-4-4	levels according to CSN EN 61000-4-5	EMC; EMI/SE according to norm:CSN EN
HRH-4/230V	3	3	55022/B
HRH-4/24V	3	3	55022/B
HRH-6/AC	3	3	61000-6-3
HRH-6/DC	3	-	-
COS-2	3	3	55022/A
Thermostats			
TER-3A	3	3	55022/B
TER-3B	3	3	61000-6-3
TER-3C	3	3	55022/B
TER-3D	3	3	61000-6-3
TER-3E	3	3	55022/B
TER-3F	3	3	55022/B
TER-3G	3	3	55022/B
TER-3H	3	3	55022/B
TER-4/230V	3	3	55022/B
TER-4/24V	3	3	-
TER-9/230V	3	3	55022/B
TER-9/24V	3	3	-
TER-7	3	3	55022/B
ATR; ATC; ATF	2	2	55022/B
DTR; DTC; DTF	2	2	55022/B
TEV-1	3	3	55022/B
TEV-2	3	3	55022/B
TEV-3	3	3	55022/B
TEV-4	3	3	55022/B
RHT-1	3	3	55022/B
RHV-1	3	3	55022/B

As is our good tradition, we have always been seeking for a maximum universality of our products. We have successfully developed a dimmer DIM-15 and SMR-M, and because the LED lighting dimming - as well as dimming of energy saving lamps - is a relatively new area and there are not so many manufacturers who produce dimmable energy saving resources, we will gradually test and expand the chart below. We welcome your feedback and cooperation in addressing your comments and new types.

Type	Light sources ELKO Lighting	Socket	Dimmable	The maximum number of units can be connected to dimmers				
				SMR-M	LIC-1	DIM-14	DIM-15	DIM-6
	DLB-E27-806-2K7	E27	yes	11	21	36	21	145
	DLB-E27-806-5K	E27	yes	11	21	36	21	145
	DLSL-GU10-350-3K	GU10	yes	25	45	74	45	300
	LSL-GU10-350-3K	GU10	yes	13	25	40	25	165
	LSL-GU10-350-5K	GU10	yes	13	25	40	25	165

Please note:
May lead to different results based on the state of network cable length and other factors.
This table contains the results of tests that were conducted internally and therefore is ONLY for customers only informative.
The products were tested in test laboratories ELKO EP, and therefore the company assumes no responsibility for any imitation test environment.

Support of project design

Our aim is to give a complete care to all electro project designers.

Our activities:

Our products are a part of the following programs:

Project programs



Award programs



DTB ELKO EP XLS



MARKS AND SYMBOLS DWG



Training

In case our products attracted your interest, do not hesitate to contact us at elko@elkoep.com or see our websites www.elkoep.com for more information.

Technical support

In case of any questions regarding use of our products for a particular project, contact us at support@elkoep.com.

Note.: logos, names, software, hardware are protected by owner's rights.

Packing of plug - in relay - 2 pcs



Packing of 2-MODULE relay - 1 pc



Packing of 3-MODULE relay - 1 pc



Packing of 1-MODULE relay - 1 pc



Packing of 1-MODULE relay - 10 pcs



Packing of 1-MODULE relay with accessories



1-MODULE DESIGN

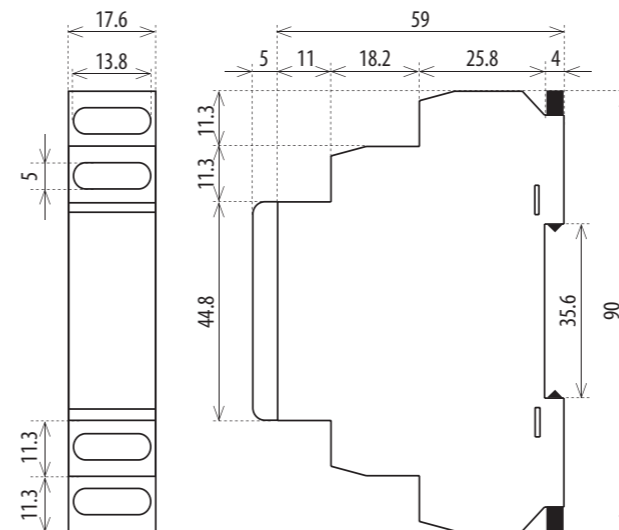

PRI-32

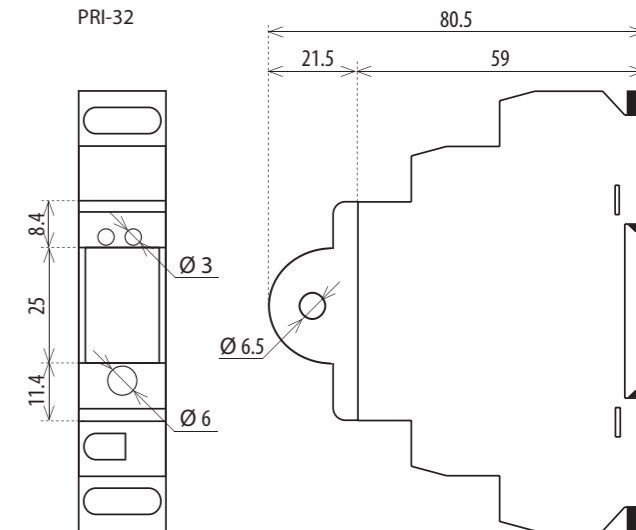

front panels 1-MODULE, examples of use:

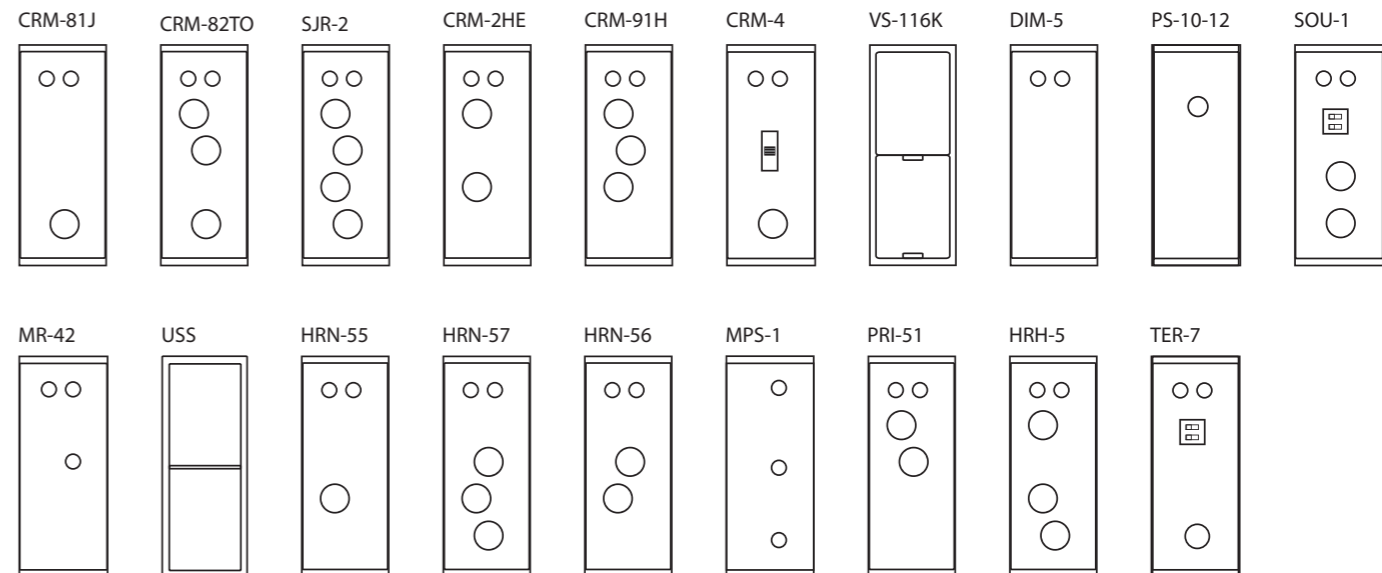

2-MODULE DESIGN

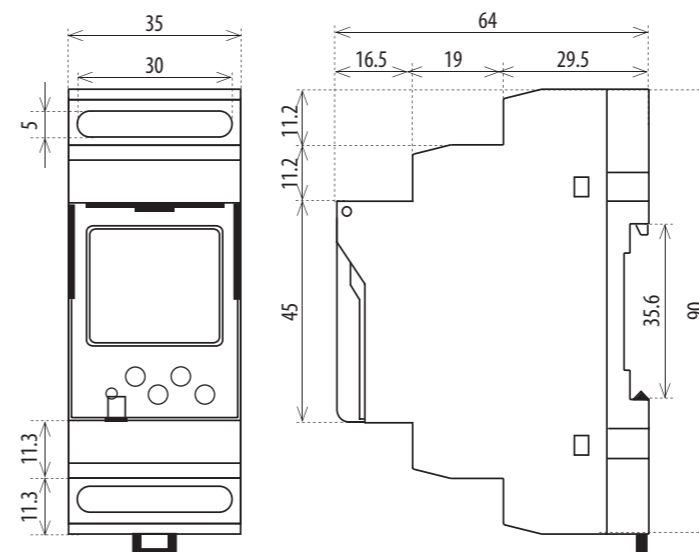

Temperature sensor

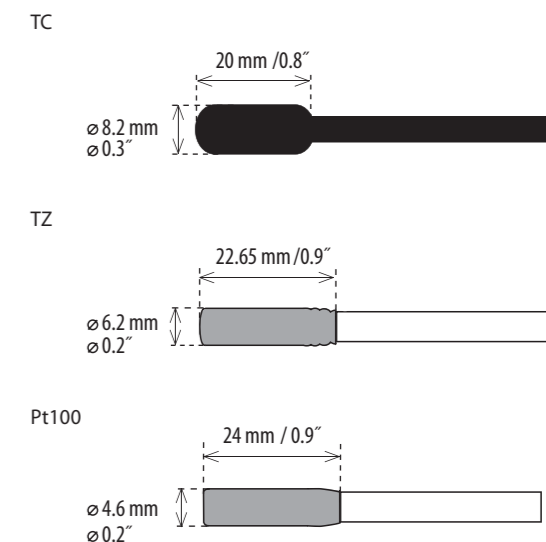

3-MODULE DESIGN

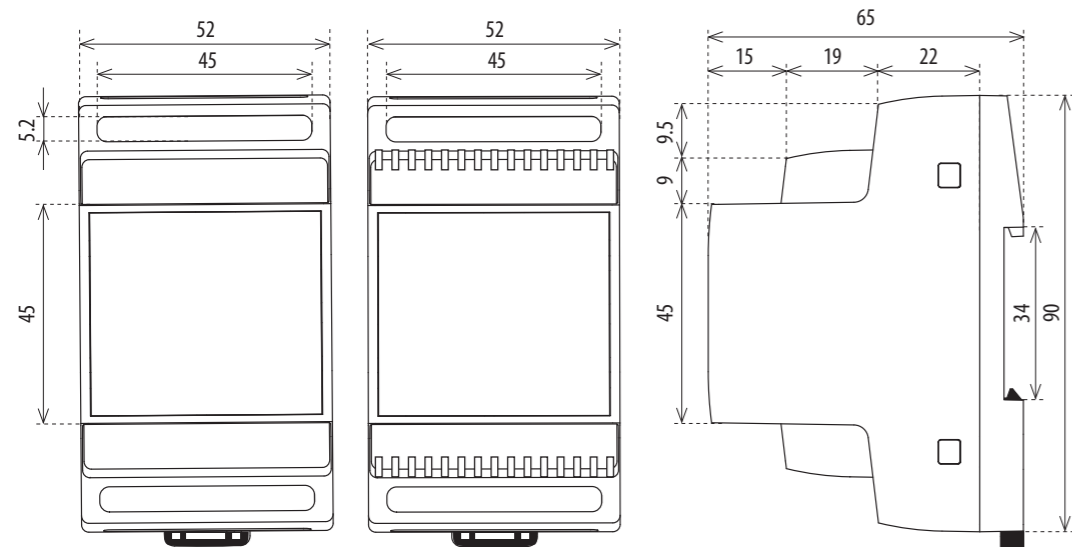

front panels 3-MODULE, examples of use:

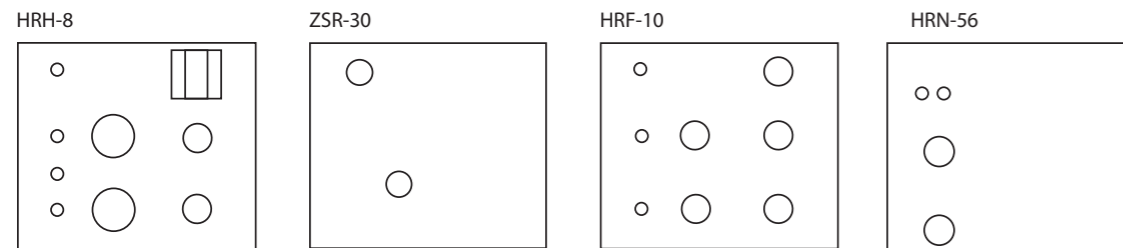
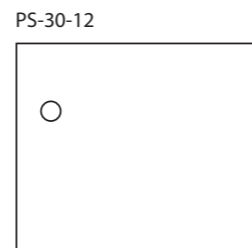
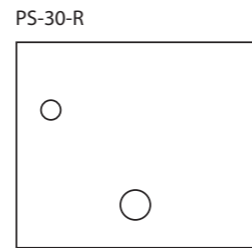
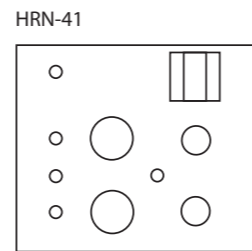

6-MODULE DESIGN

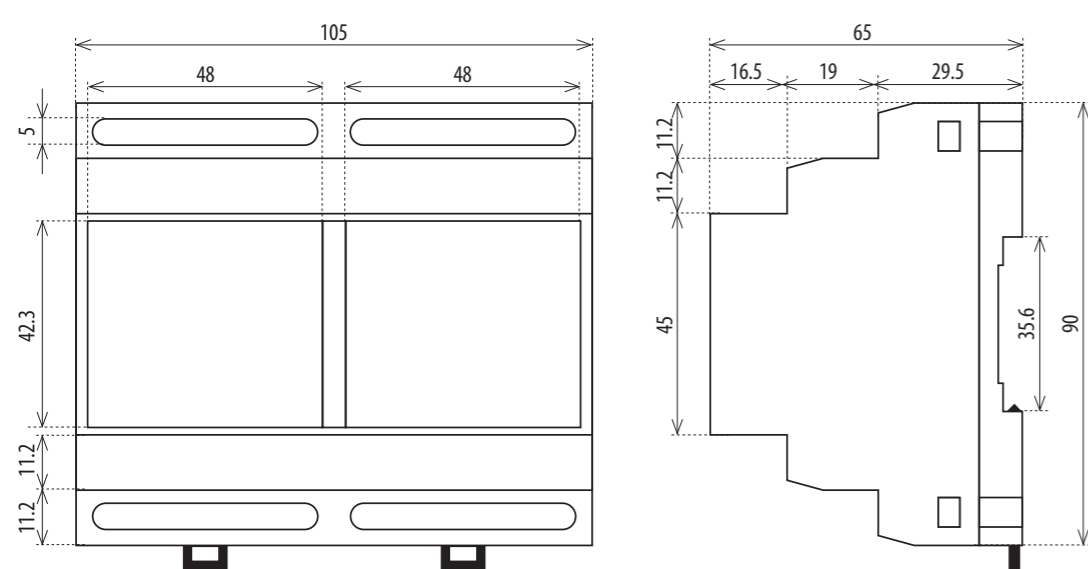

front panels 6-MODULE, examples of use:

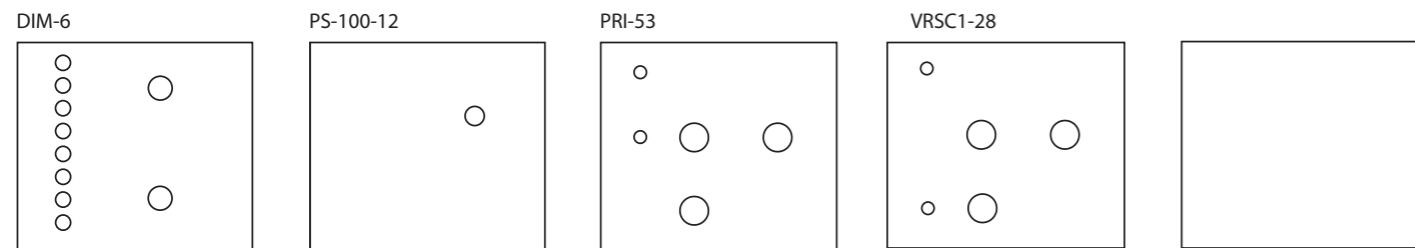

SMR-T, SMR-H, SMT-K

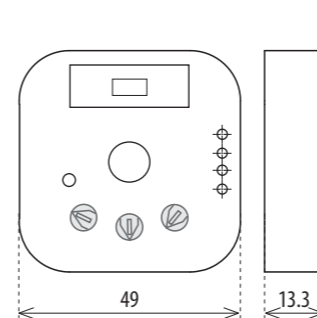

SMR-S, SMR-U

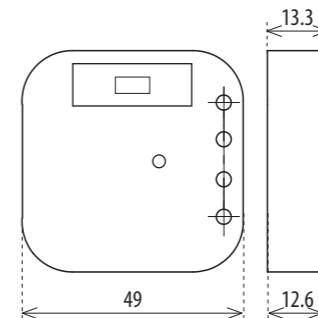

SMR-B

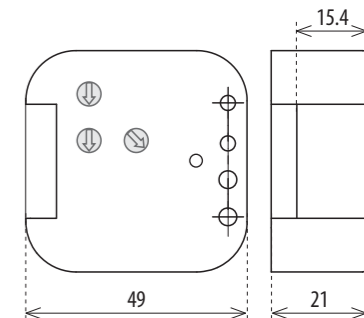

VS116/B

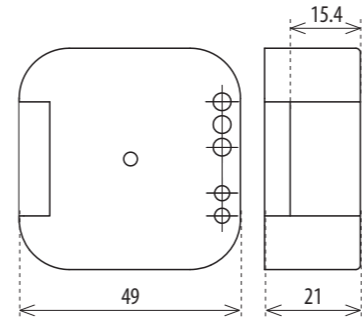

SMR-M

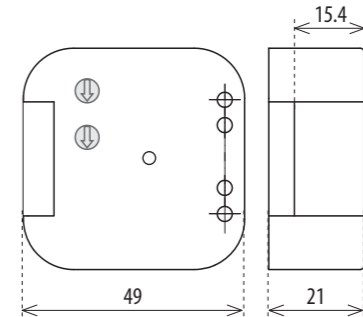

PSB

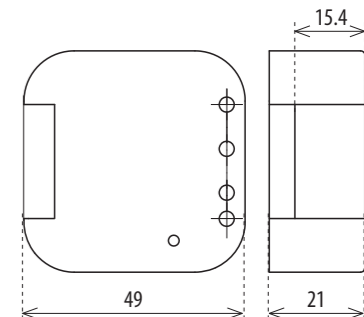

ATR, ATF, ATC

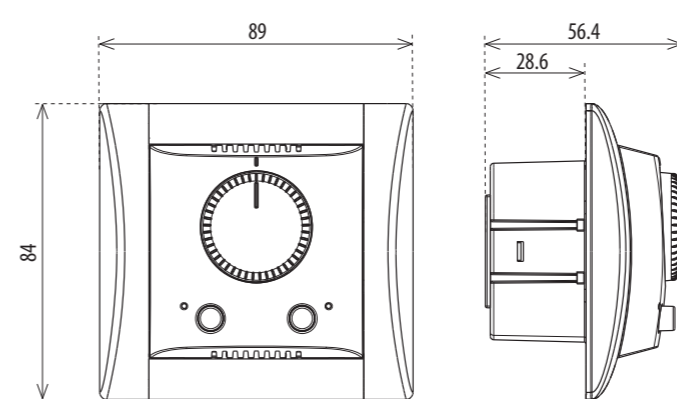

DTR, DTF, DTC

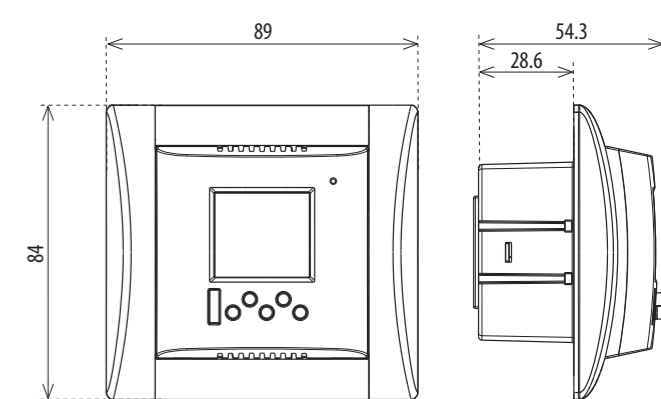

RHV-1, TEV-4

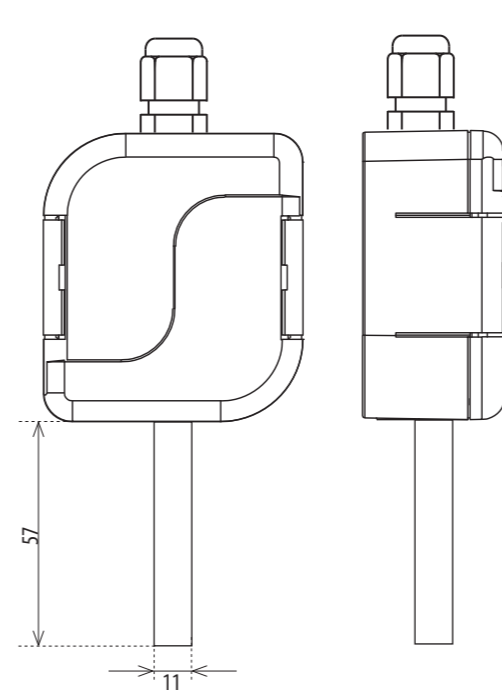

SOU-3

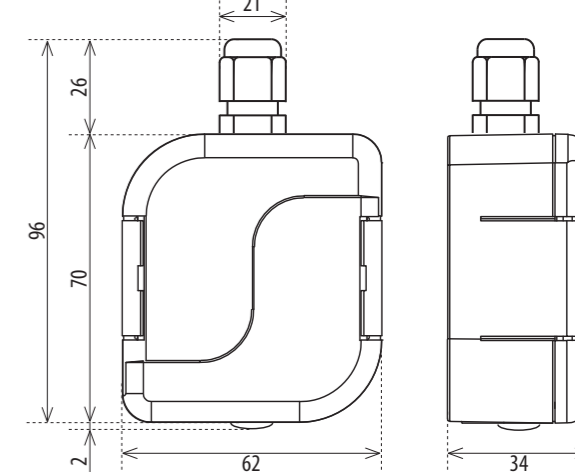

Dimensions

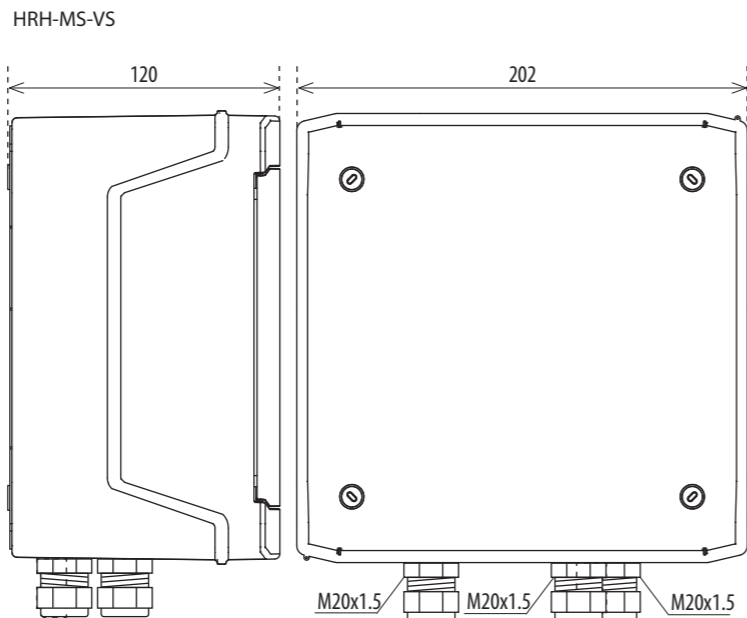
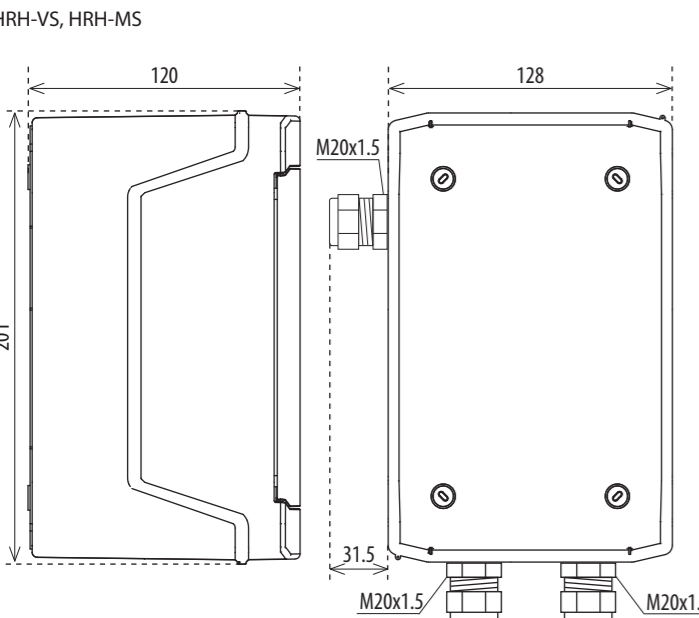
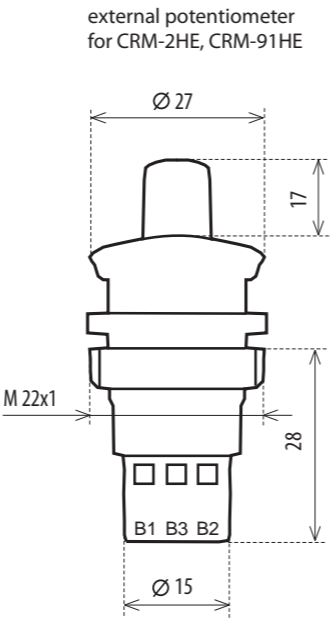
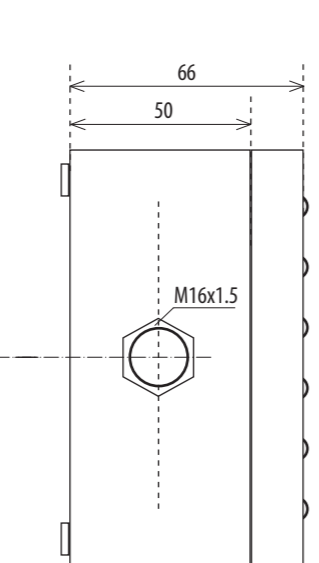
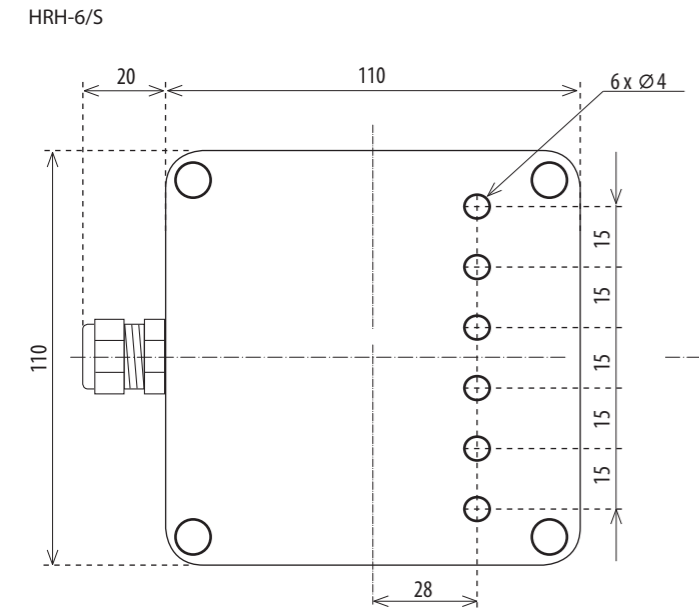
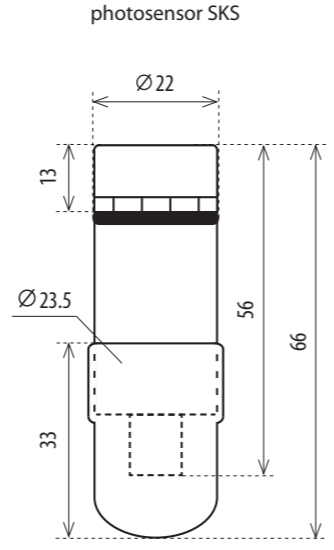
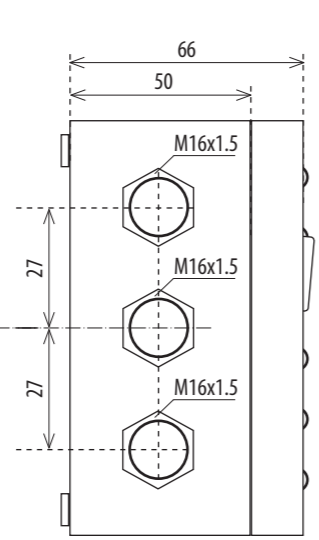
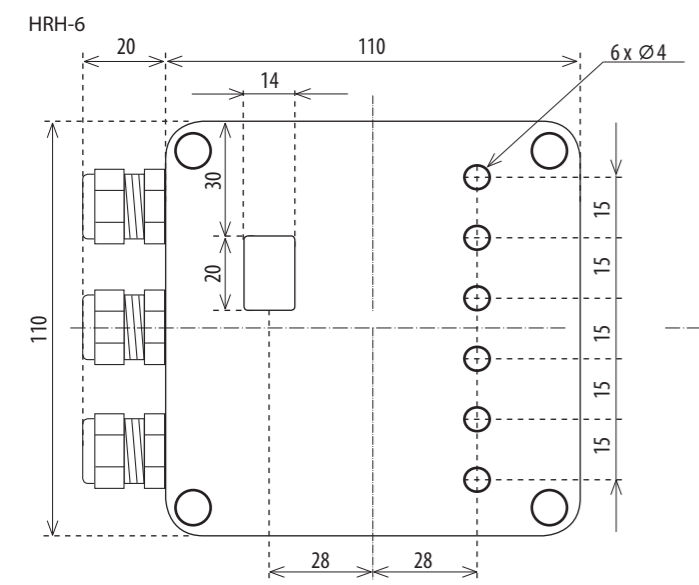

Dimensions

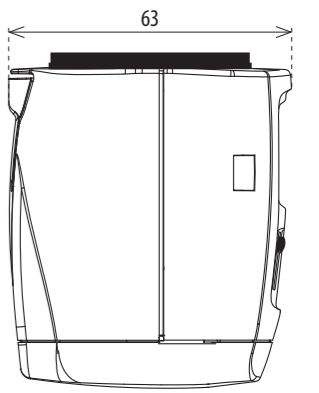
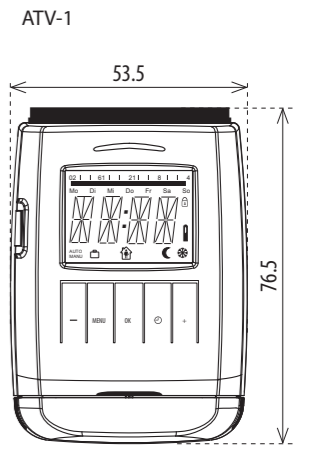
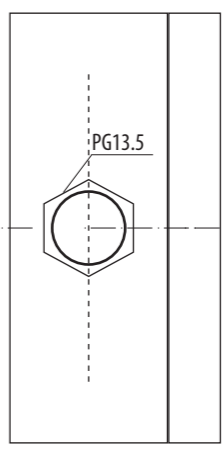
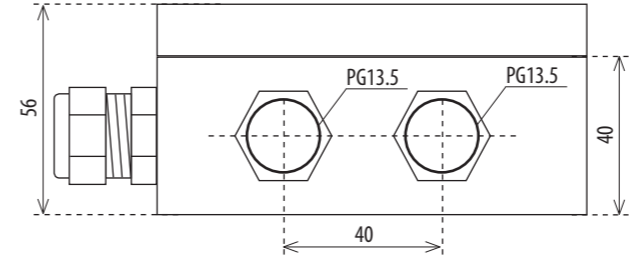
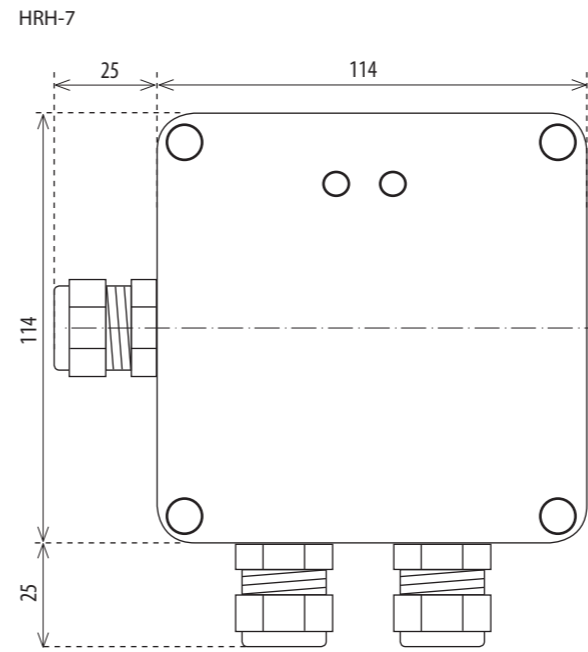
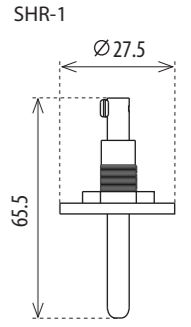
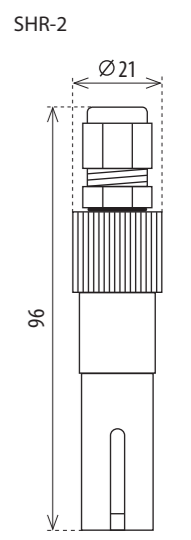
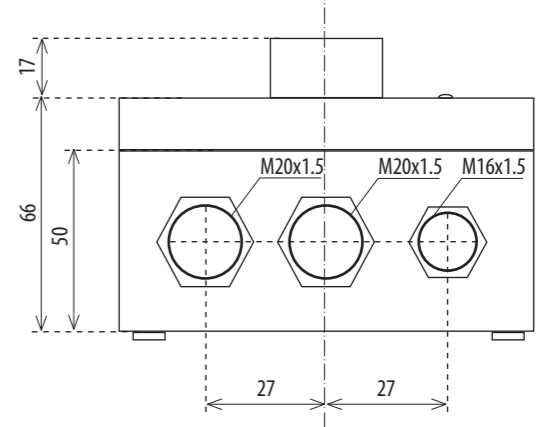
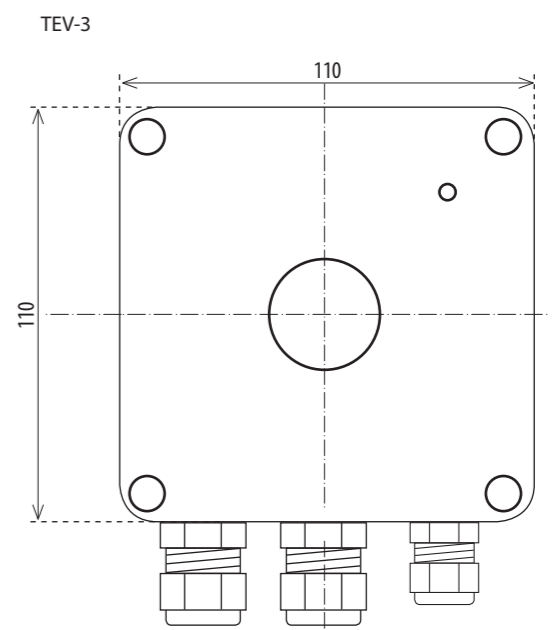
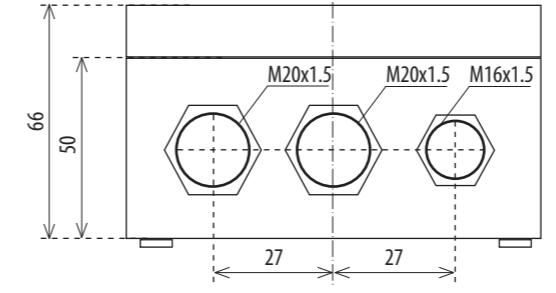
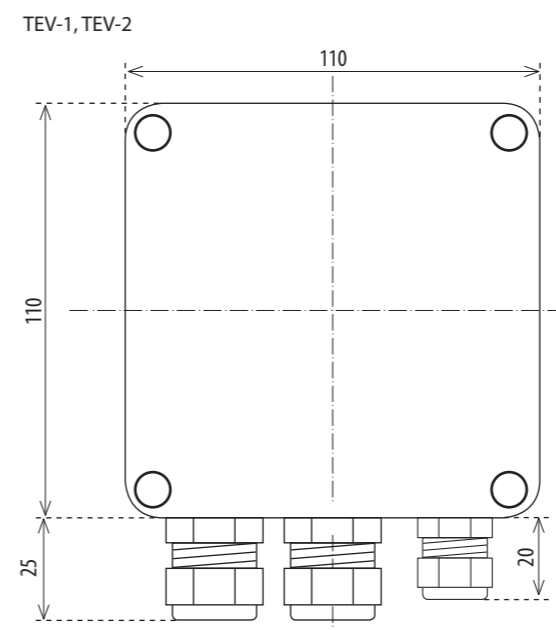

PRM-91H/11, PRM-91H/8, PRM-92H, PRM-2H

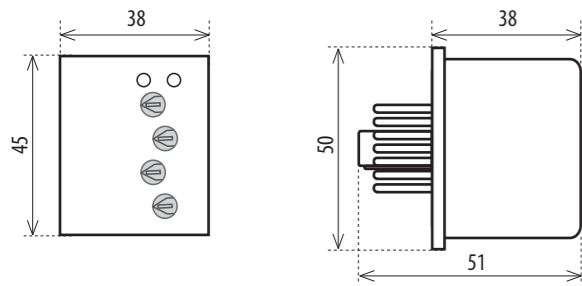

Level sensor SHR-3

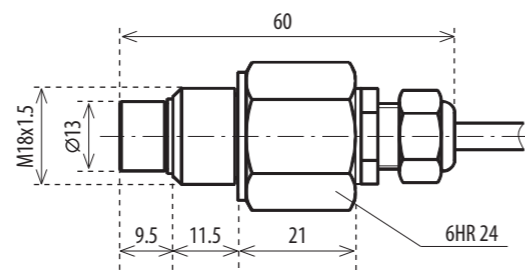

782L

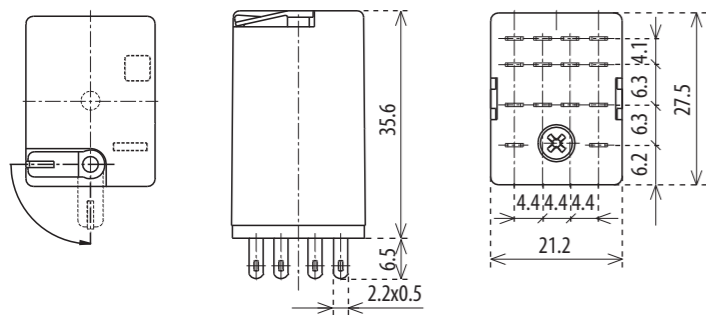

750L

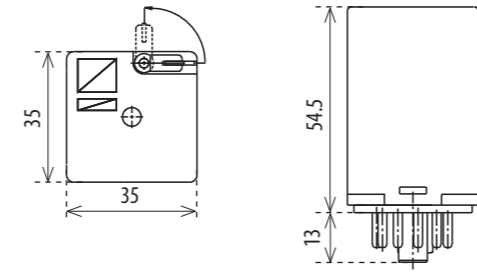

Socket for PRM-91H/11, PRM-92H, PRM-2H, 750L

Socket for PRM-91/8

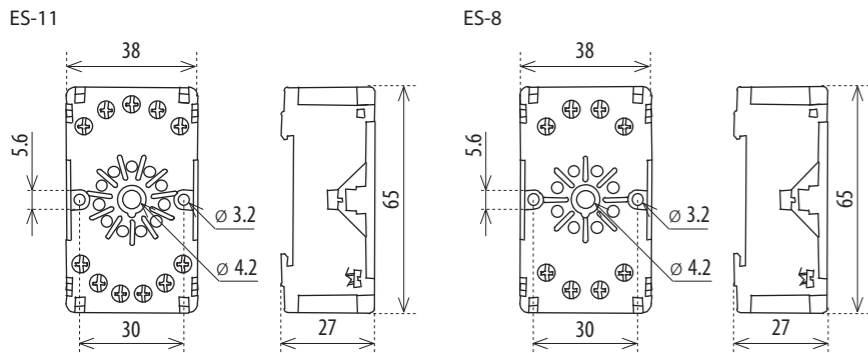

Socket for 782L

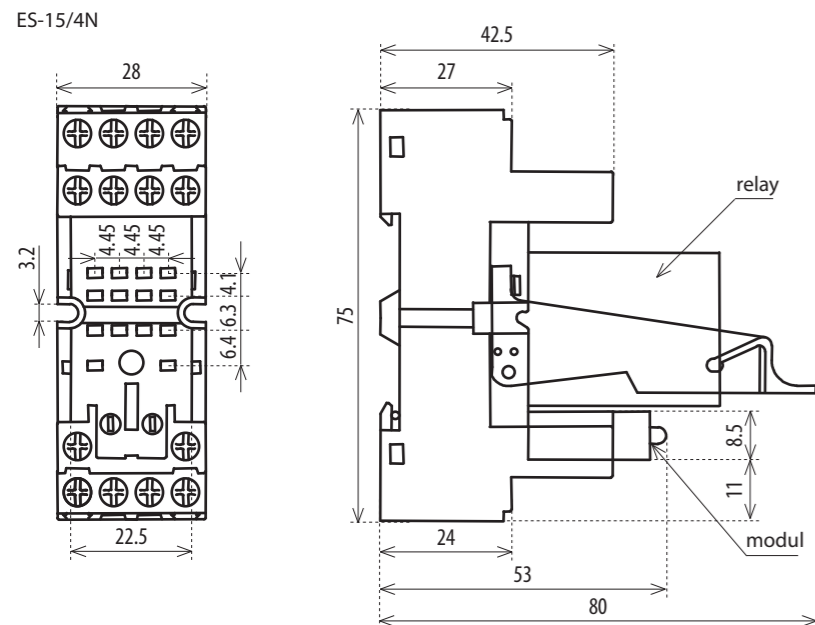

USS

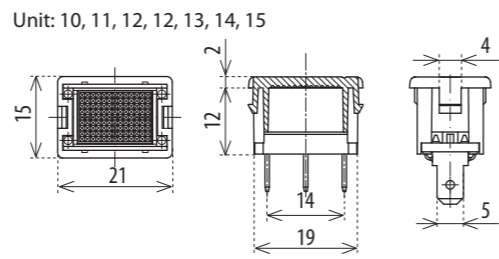
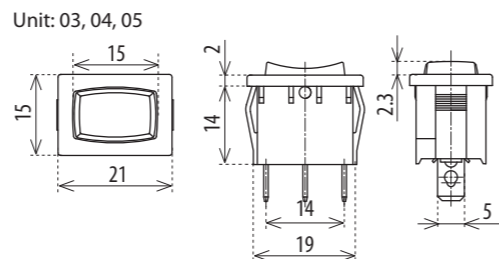
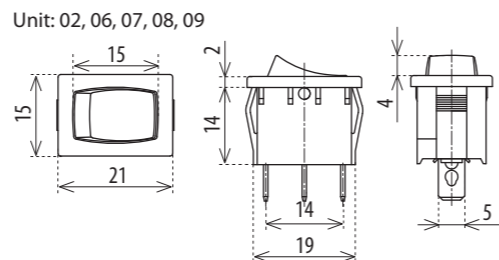
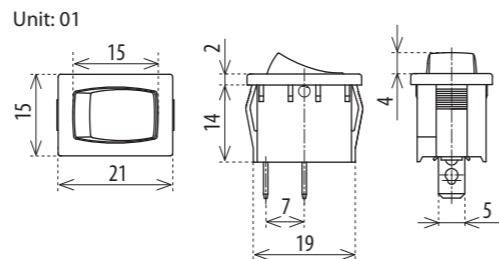
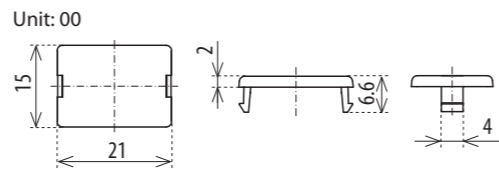

VS120 VS220 VSM220

VS425 VSM425

VS440 VS463

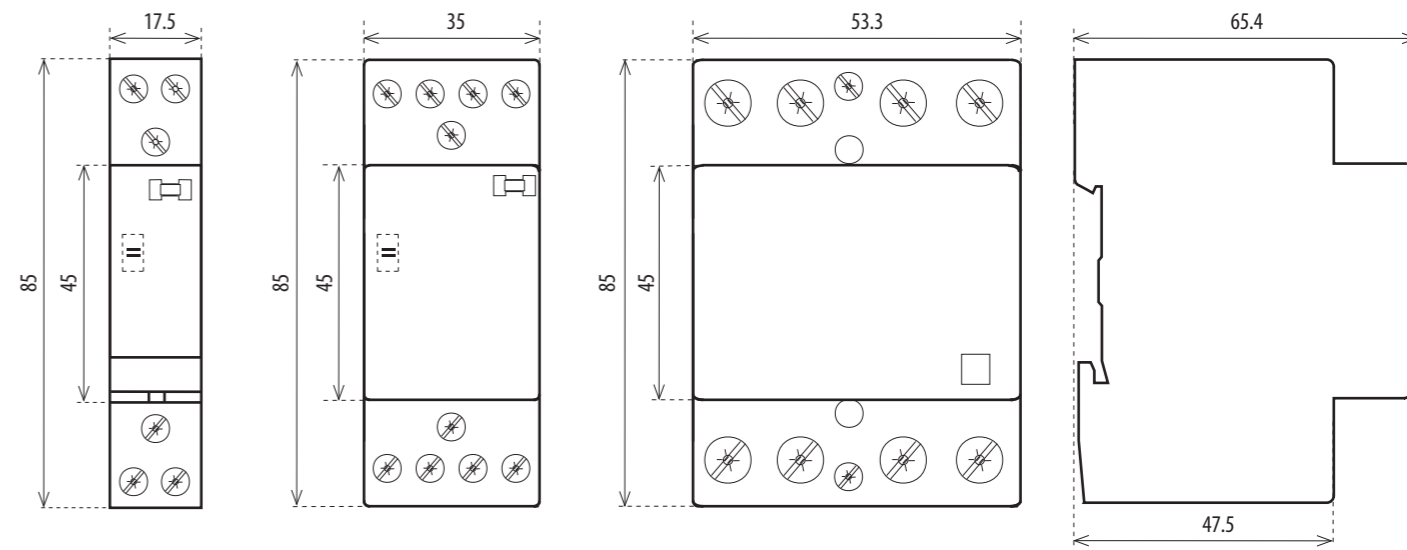

VS420

VSK-20

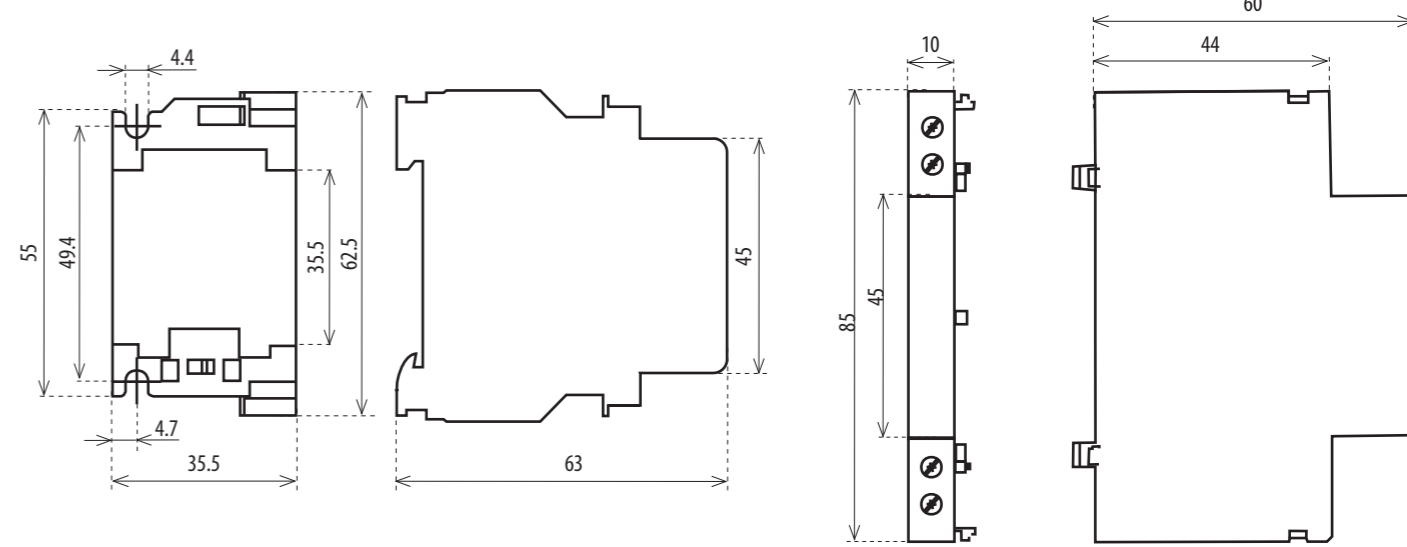

IKV

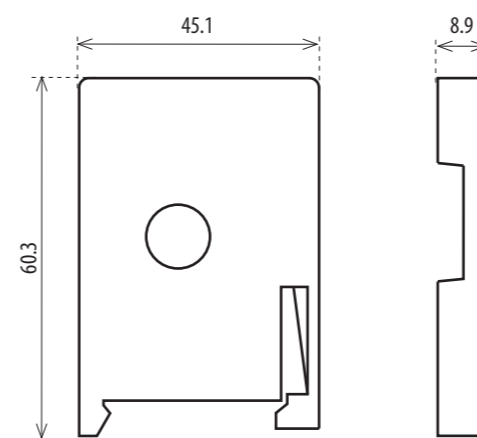

CRM-100

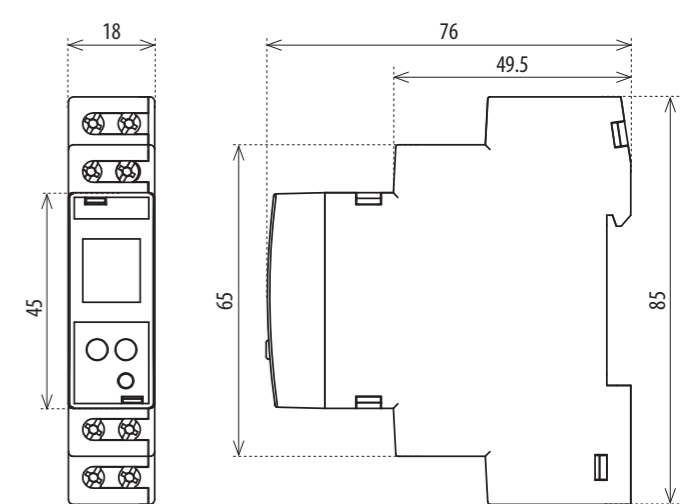

Multifunction time relay CRM-91H, CRM-93H

- for electric appliances, where is necessary to change the exact timing - controlling of the illumination, heating, motors, machines, ventilators, contactors...



Multifunction time relay with contactless output CRM-9S

- using for warning illuminatin on the road, flashers, cyclers, often switched systems ...



Multifunction time relay with external potentiometer CRM-91HE

- time adjusting via external operating unit, operating on panel, switchboard doors

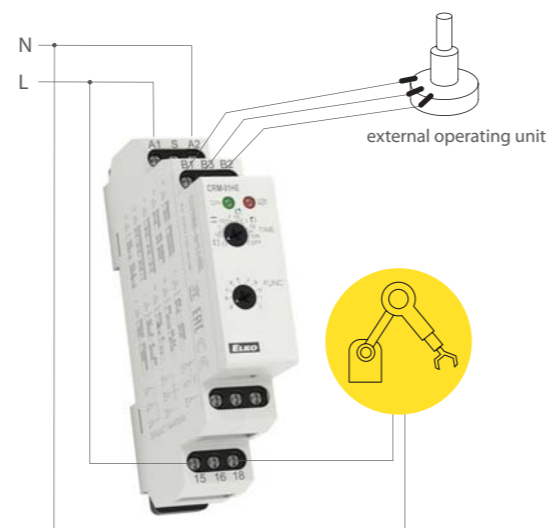

Singlefunction time relay CRM-81J

- time switch, using for run down the pump after switch off the heating, switching of ventilators ...



Multifunction time relay CRM-61

- for electronic appliances, light control, heating, motors, fans....

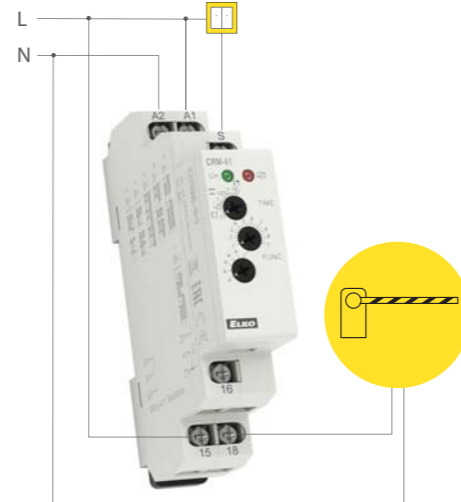

Time relay plug-in type PRM-91H, PRM-92H

- serves to control light signalization, heating, motor and fan control etc.



Delay OFF without supply voltage CRM-82TO

- delayed back-up switch off at current failure (emergency illumination, emergency respirator)

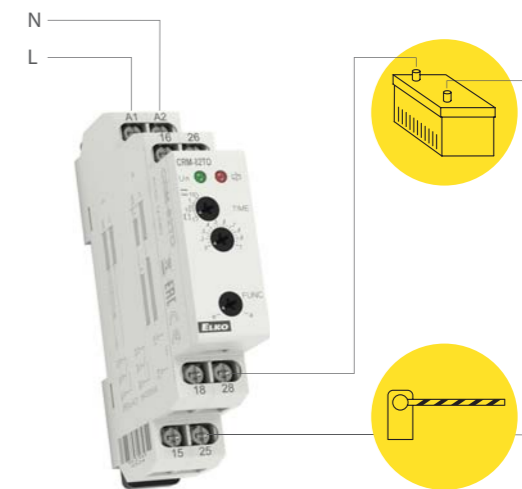

Doublestage delay unit SJR-2

- for sequential load switching, electric furnaces, heaters...

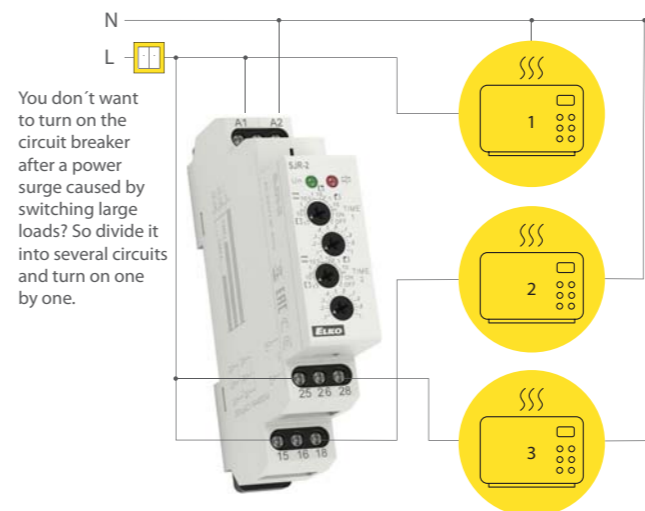

Asymmetric cycler CRM-2H

- regular rooms ventilation, cyclic humidity exhaustion, illumination controlling, circulation pump, flash, warning appliances, regular pump down, regular irrigation via electromagnetic valve



Staircase switch CRM-4

- staircase automatic systems, ventilators switching, for multiplace operating illumination on the staircases and halls...

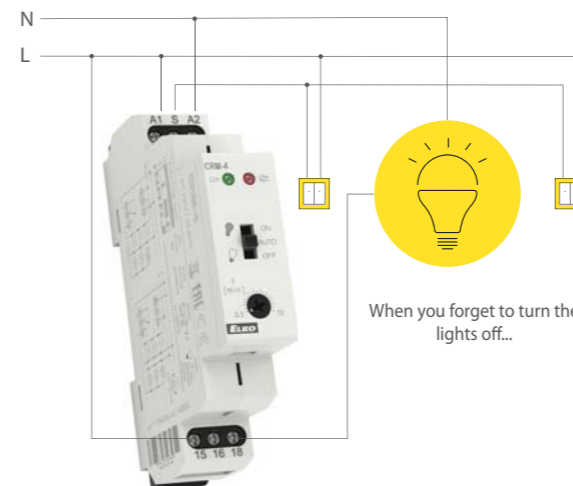

Progammable staircase automat with signalling before switch off CRM-42

- starcaise illumination operation - on-coming switch off signalling (flash = comfort + safety together)

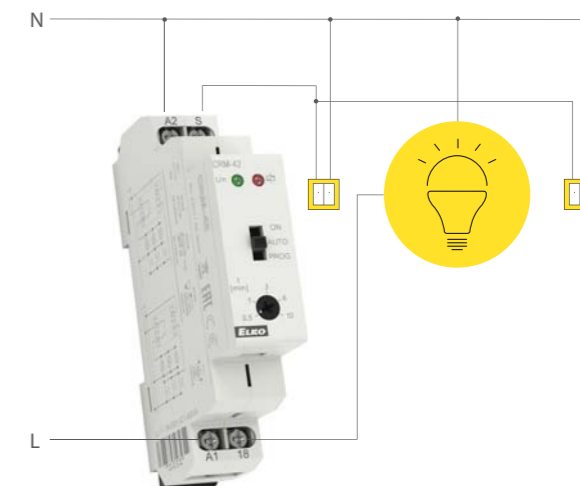

Digital time switch SHT-1/2

- for controlling of all appliances that depend on real time, appliances could be controlled in regular cycles, or according to adjusted program (blocking of main door out of working hours or night)
- in combination with other devices, controlling could be combined (rooms ventilation, irrigation controlling, bell at school or in church...)

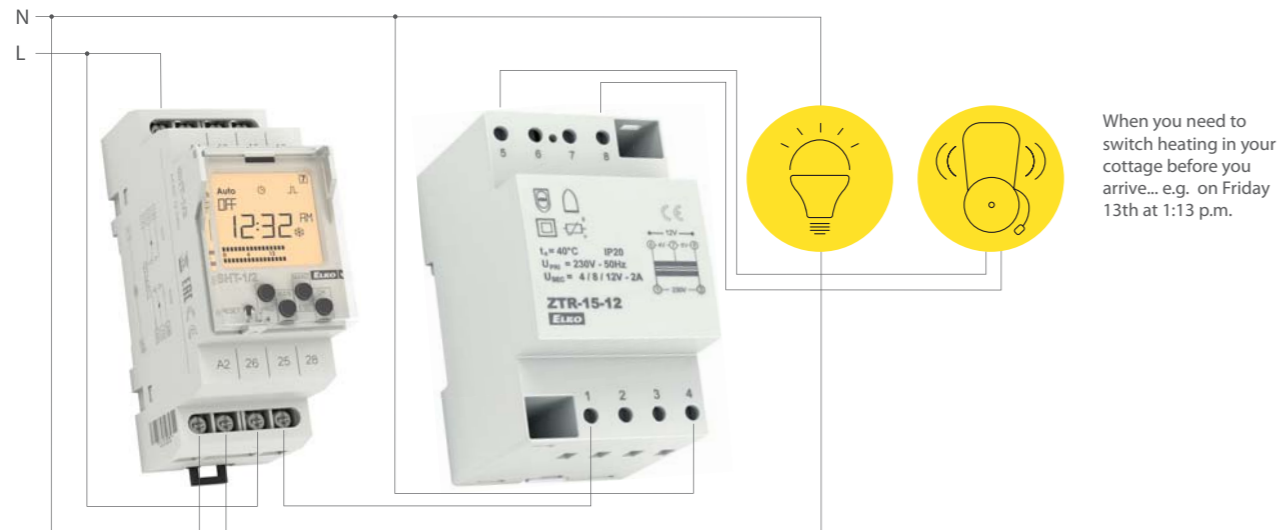

Programmable digital relay PDR-2

- illumination, ventilators, contactors controlling, controlling of interlocking plans, system of time abate and blocking (billiards, pin-balls...), away control via external buttons

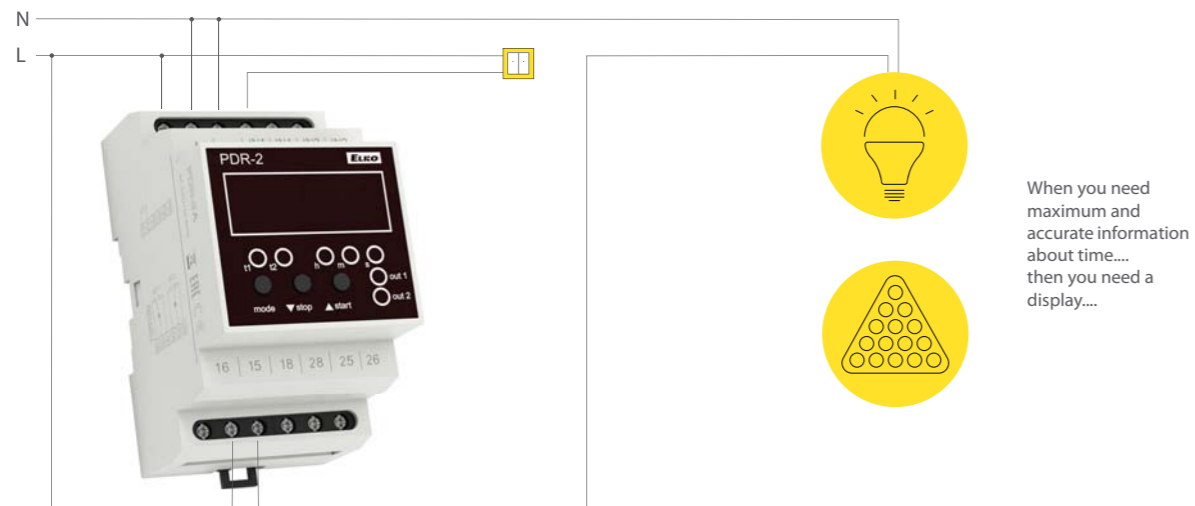

Twilight switch SOU-1

- outdoor illumination switching (garden illumination), flash, shop-window, hall and office illumination (switch off in desired light level, controlling of intensity)

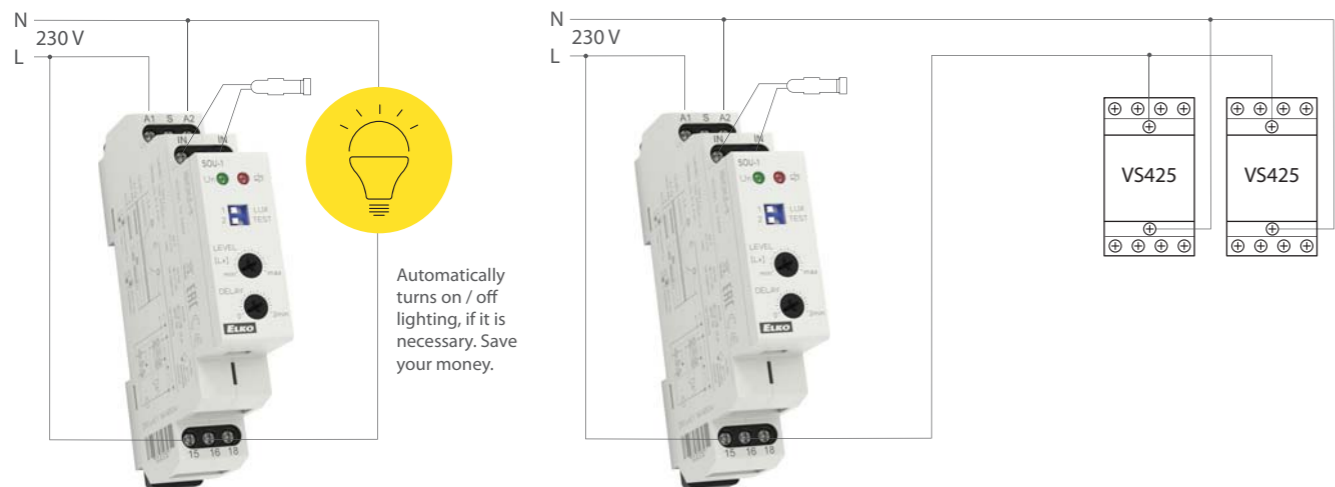

Delay on star/delta CRM-2T

- motor starting more than 3 kW, electronic switchover from mode start to mode operation with device CRM-2T, what assures exact timing

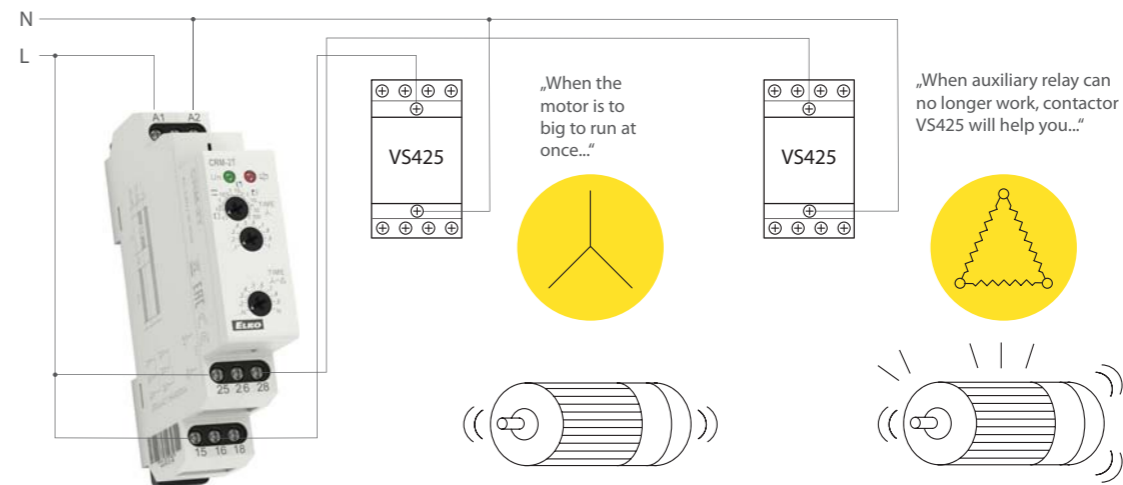

Modular contactor VS120, VS220, VS420, VS425

- to switch circuits for supply and control of heating, lights, air-conditioning and other el. devices.
- Switches loads AC-1, AC-3, AC-7a, AC-7b, AC-15.

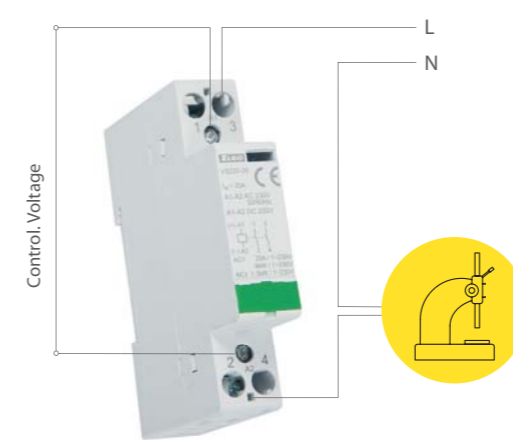

Mini contactor VS425

- switching of the higher loads, especially in other categories than AC1

Modular contactors VS440, VS463

- to switch supply and control circuits for heating, air-conditioning and other el. devices, switching 3-phase motors
- Switches loads A-1, AC-3, AC-7a, AC-7b, and AC-15

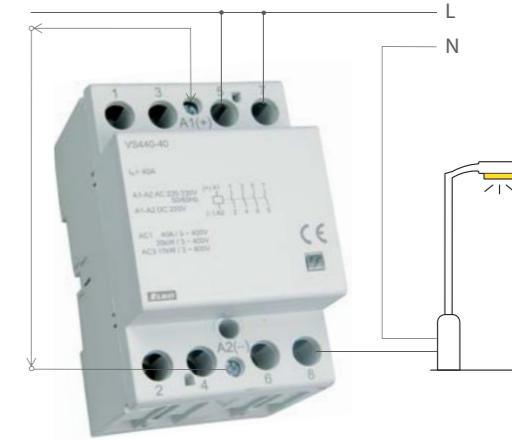

Auxiliary plug-in relays 750L, 782L

- to switch bigger output (load)

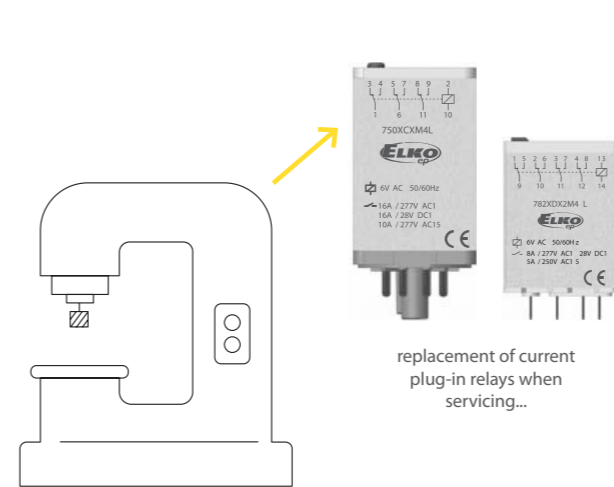

Digital time switch SHT-1, SHT-1/2

- for controlling of all appliances that depend on real time, in daily or weekly mode

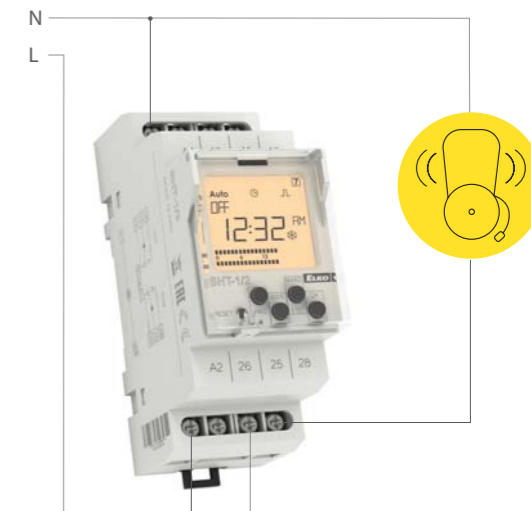

Staircase automat with dimming DIM-2
 - step by step (fluent) dim up, adjusted time is ON and fluent dim down (e.g. possible to adjust permanent shine to min. brightness everlasting light)
 - block of flats (entry, halls, staircases), garden lighting

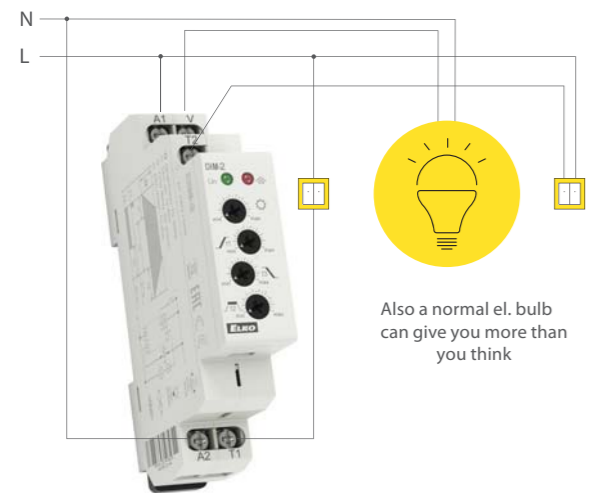

Also a normal el. bulb can give you more than you think

Controlled dimmer DIM-5
 - short press ON/OFF, long press - brightness regulation, is in memory. Other presses activate memory
 - switch on and dimming of hall, staircase ...

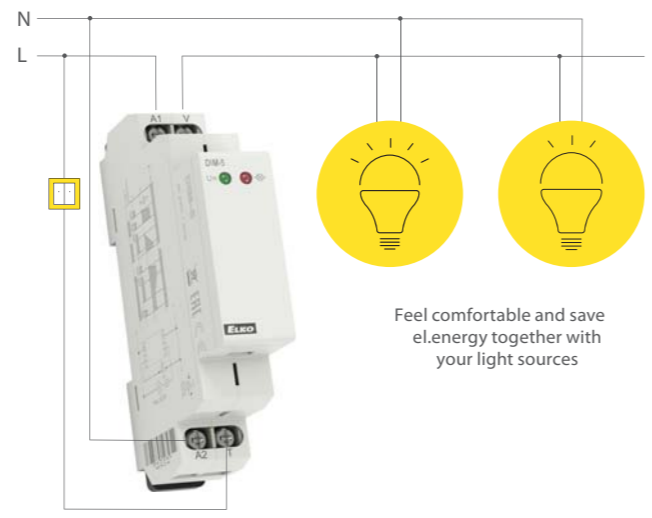

Feel comfortable and save el.energy together with your light sources

Memory relay MR-41, MR-42
 - because of 2-wire parallel buttons connection save money, place and time during the installation
 - light switching, hall, staircase, big rooms, controlling systems, automation

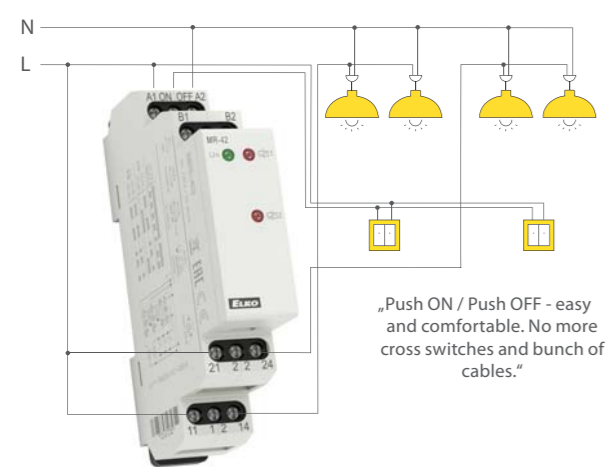

„Push ON / Push OFF - easy and comfortable. No more cross switches and bunch of cables.“

Power relays VS
 - switching of higher load than is capacity of switched unit = repeater
 - assistant light controlling, signalling, boilers, ...



„They will help you, they will intensify and extend...“

Switching power supply PS-R
 - power supply of any devices and appliances via safe voltage with full galvanically separated from mains
 - power supply of driving systems, interlocking plants and use in measurement and control



Controlling and signalling units USS
 - compact dimensions, elegant design, wide range of use, configuration for request
 - switching and signalling in switchboard, controlling centre, automation...

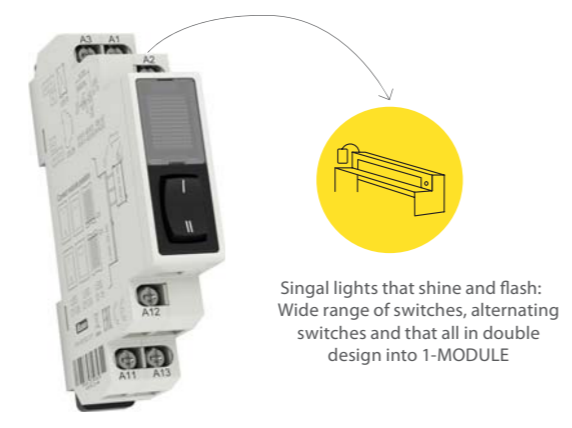

Singal lights that shine and flash: Wide range of switches, alternating switches and that all in double design into 1-MODULE

Monitoring voltage relay HRN-33 (35)
 - monitoring of mains voltage for appliances inclinable to supply tolerance

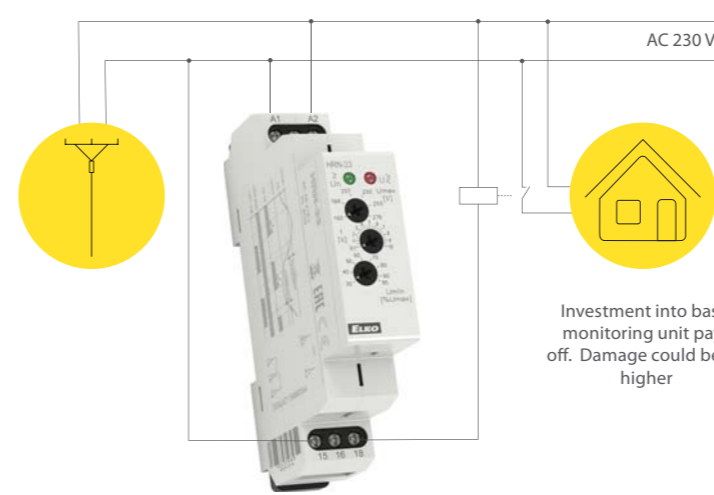

Investment into basic monitoring unit pays off. Damage could be far higher

Monitoring voltage relay HRN-33 (35)
 - protection of appliances against under-/overvoltage

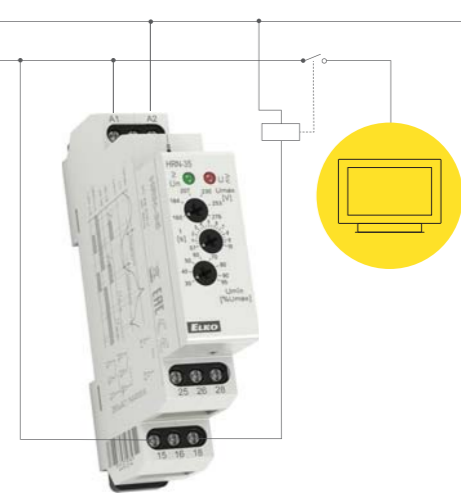

Monitoring voltage relay HRN-35
 - start of back-up supply in case of failure

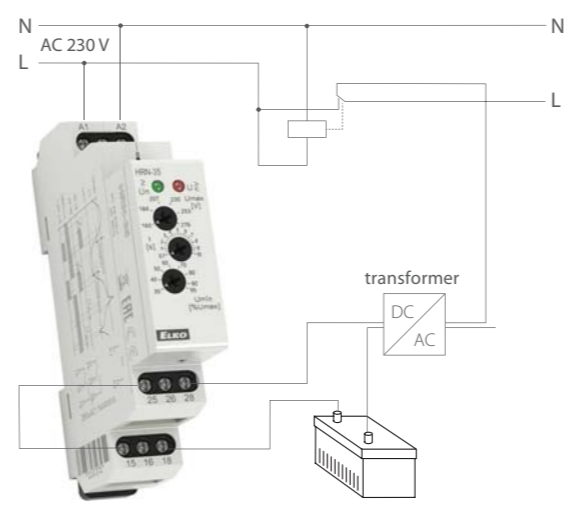

Monitoring voltage relay HRN-34
 - load disconnected when voltage declines or battery is discharged

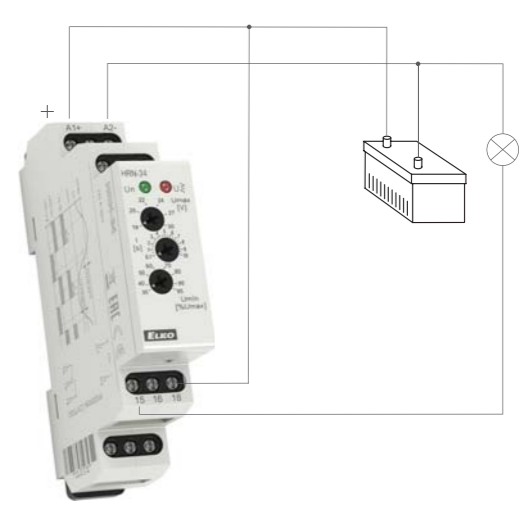

Monitoring current relay PRI-51, PRI-32
 - current-limiting relay (on one branch two appliances, which never work together), controlling systems, motors, heating, current indication, controlling of 1-phase motor run down, during the installation of main housing switchboard could be controlled via eye, if the cooker is not switched
 - in connection with current transformers, it is possible to extend current ranges up to 600A, which makes more things possible

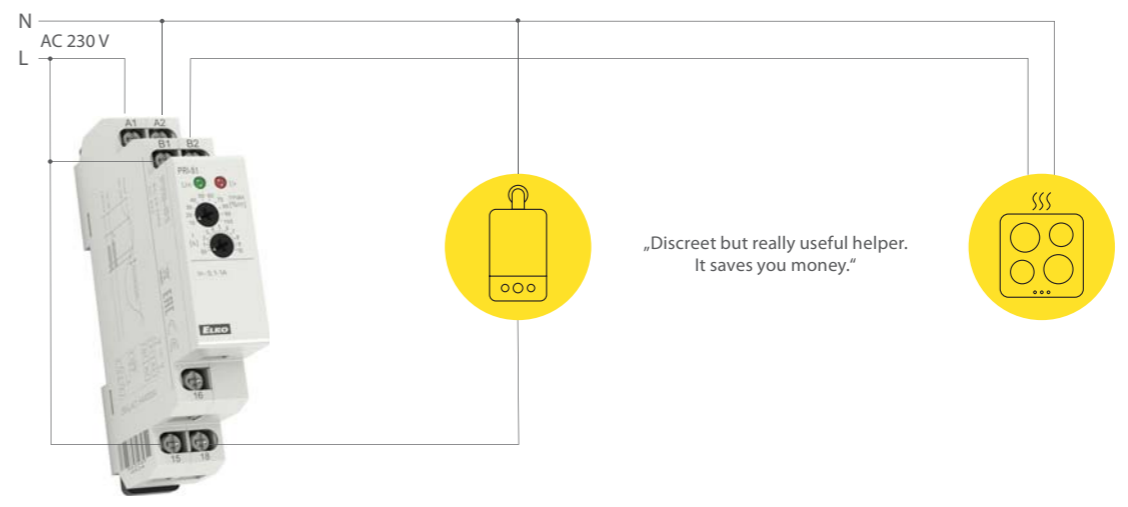

„Discreet but really useful helper. It saves you money.“

Relay monitoring power factor COS-2
 - monitors power-factor in 3-phase mains / unloading of motors, pumps, lift systems

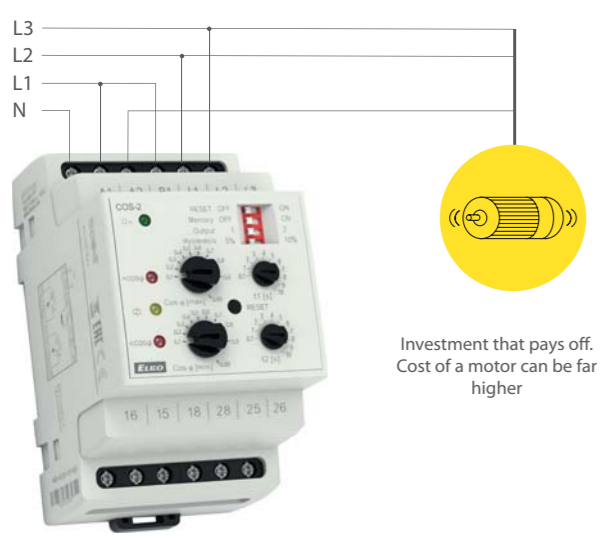

Monitoring voltage relay HRN-43
 - regulation of voltage from generator, water el. plants, 3-phase control in the main
 - monitors and protects main's quality

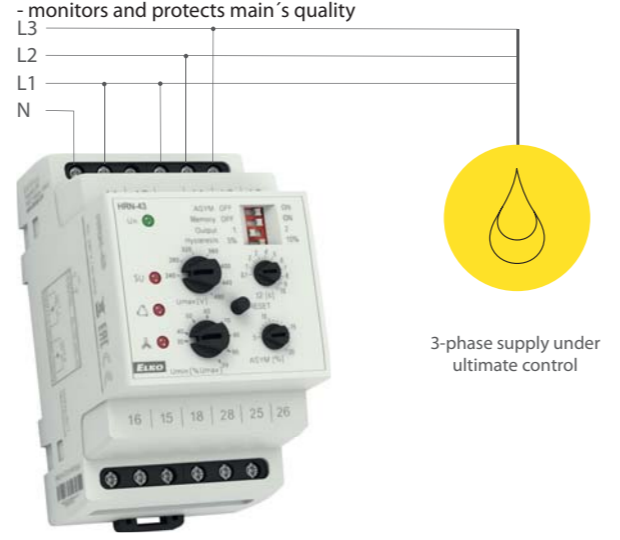

Relay monitoring sequence and failure of phases HRN-55, HRN-55N
 - monitoring of proper motor rotation, electric drive, etc.

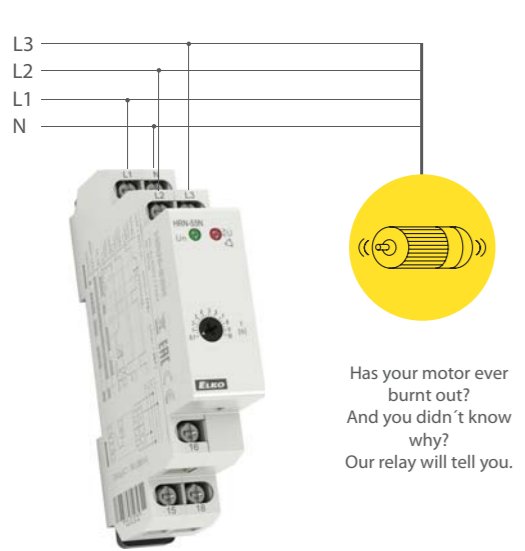

Relay monitoring over-/undervoltage in 3-phase mains HRN-54N
 - monitoring voltage in switchboard, protection of appliances

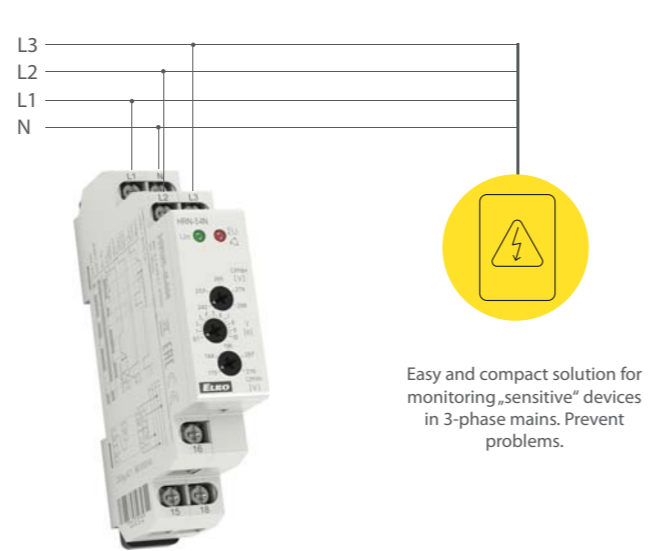

Monitoring voltage relay for under/vervoltage for 3-phase mains HRN-54
 - comfortable monitoring of 3-phase mains

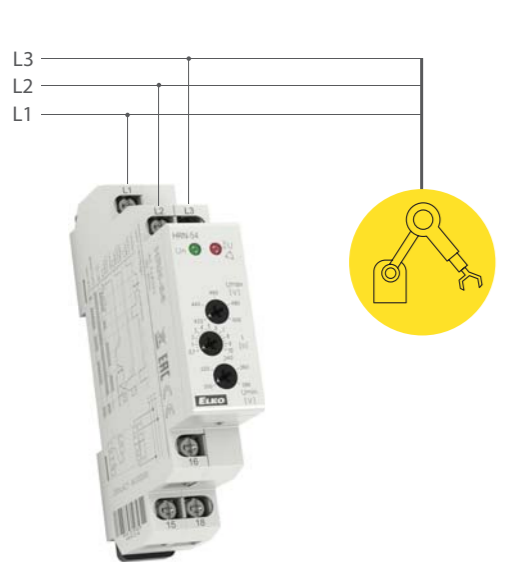

Monitoring current relay PRI-41 (PRI-42)
 - monitoring over-/underload (machine, motor ...)
 - monitoring consumption, diagnostics of distant appliance (short circuit, increased consump. ...)

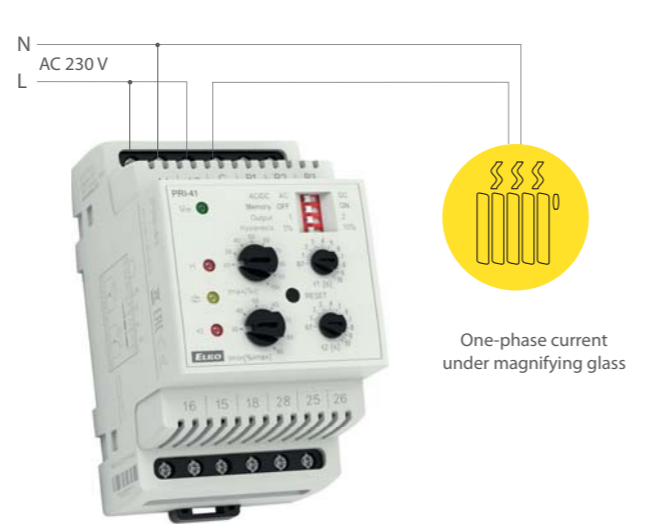

Level switch HRH-8
 - monitoring level in wells, tanks, pools, etc.

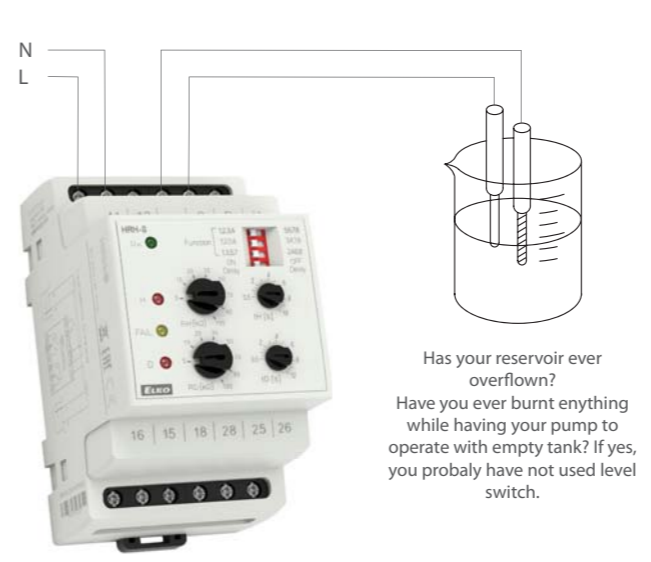

Level switch HRH-5
 - monitoring level in well, sump, tanks, silo...

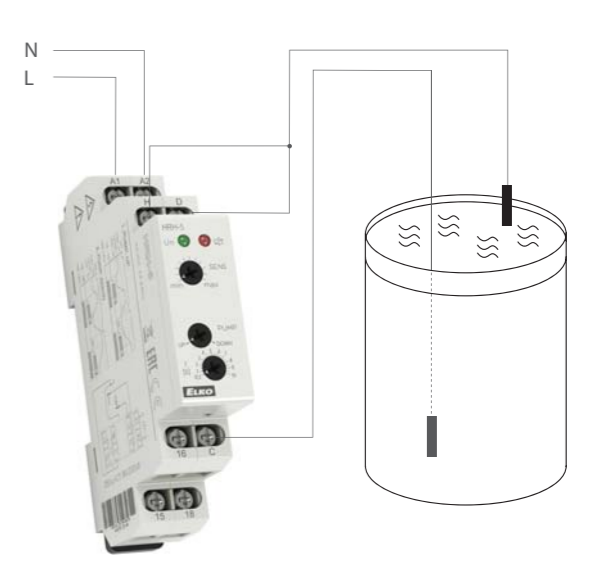

Thermostat TER-3 with external sensor
 - control of temperature of floor heating

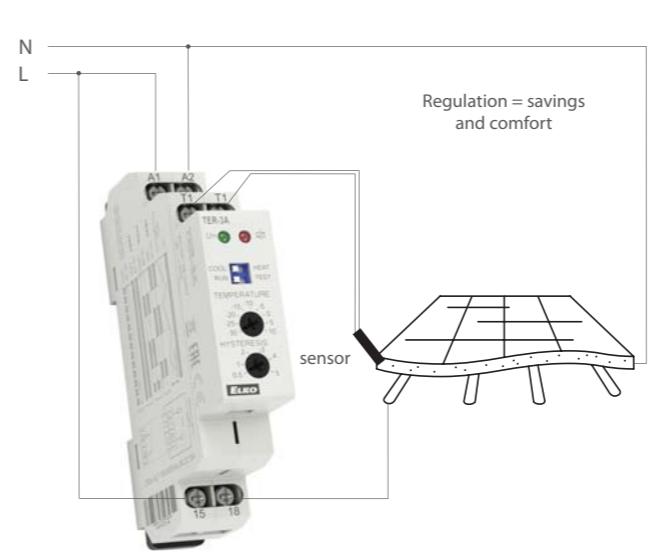

2 stage thermostat TER-4 with 2 external sensors
 - control of temperature of e.g. gas/electric boiler

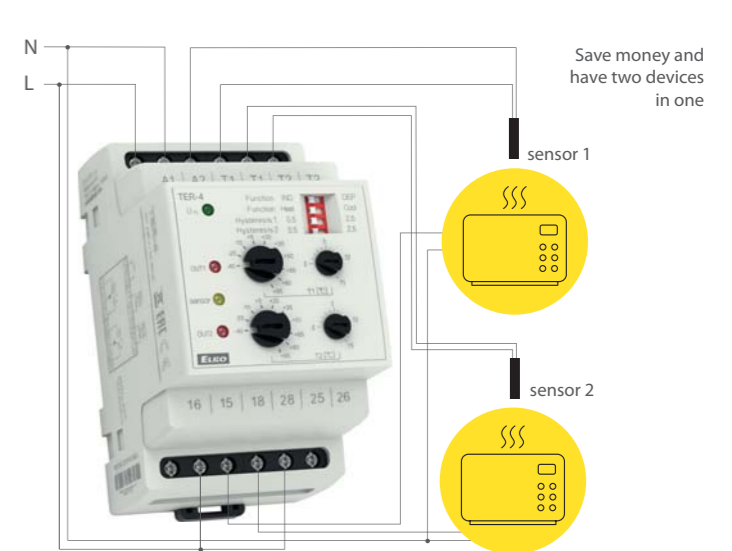

Thermostat for thermal protection of motors TER-7
 - protection of motors against thermal overload

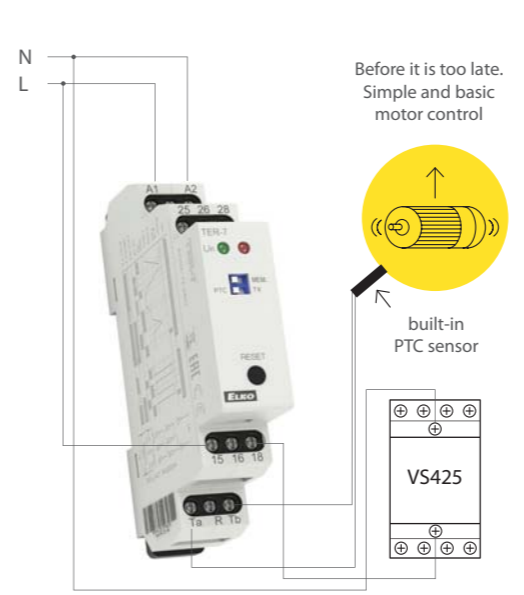

Multifunction digital thermostat TER-9
 - complex control of heating and water heating in a house



Others just resell
HOWEVER, WE DEVELOP AND MANUFACTURE
PRODUCTS OURSELVES!



26 years
on the market



15 years
ISO certification

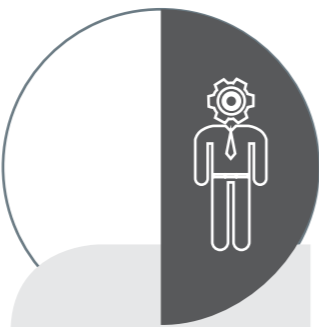

40
developers



330
employees



2000m²
manufacturing
space

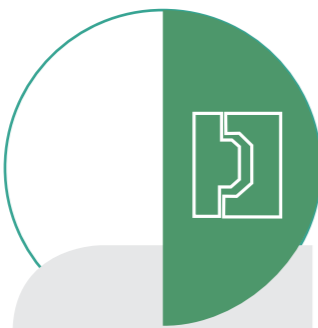

200
proprietary plastic
mods

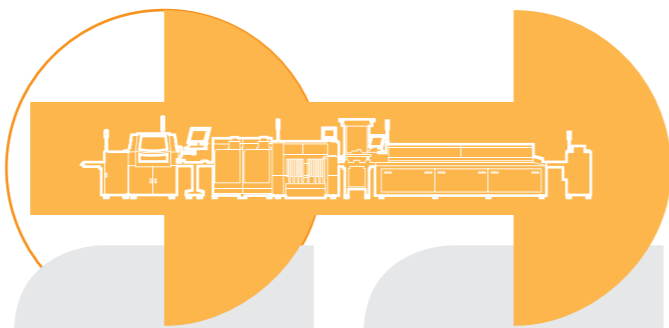

2
SMD lines

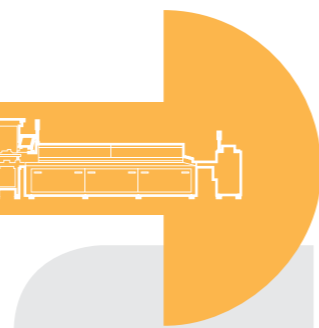

1 mil.
components
per day

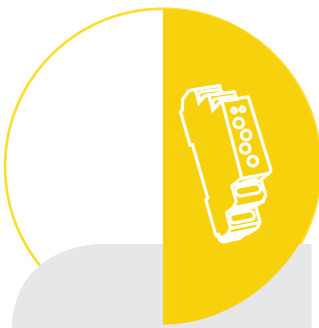

600 000
products
per year

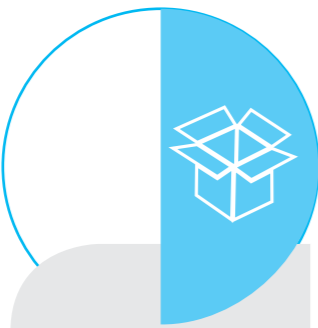

2 000 m²
finalization
and dispatch



2000
warehousing
spaces



2
printing lasers

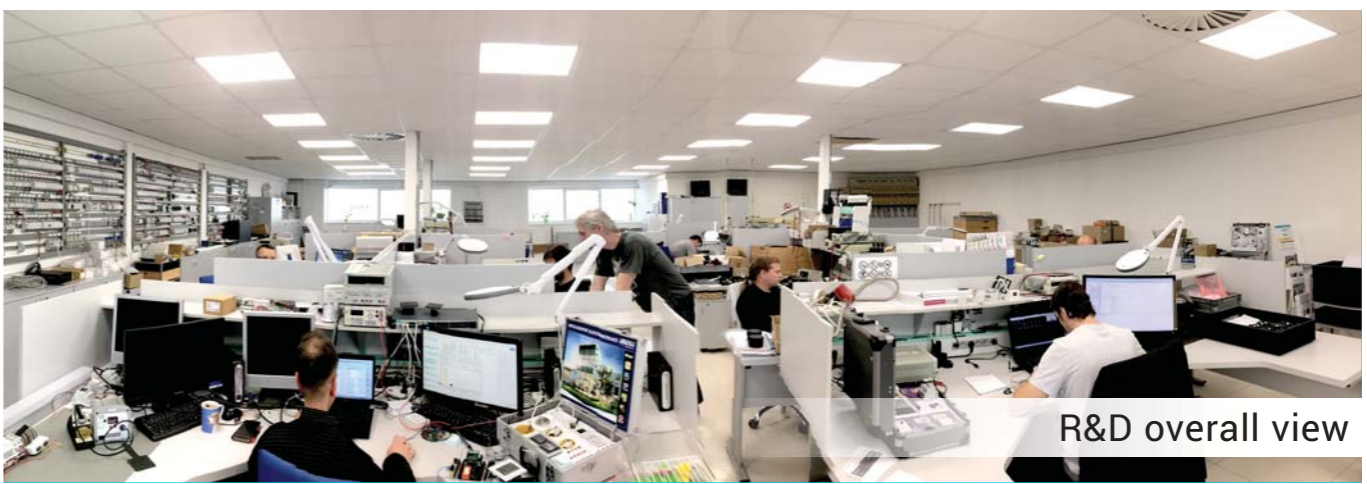

R&D overall view



Manufacturing hall



Testing lab



Finalization and dispatch



ELKO EP, s.r.o.

Palackeho 493 | 769 01 Holesov, Vsetuly | Czech Republic
phone: +420 573 514 221 | fax: +420 573 514 227 | elko@elkoep.com | www.elkoep.com

Published: 05/2019 | Modifications or amendments reserved | © Copyright ELKO EP, s.r.o. | 2st edition