

# MONITORING RELAYS

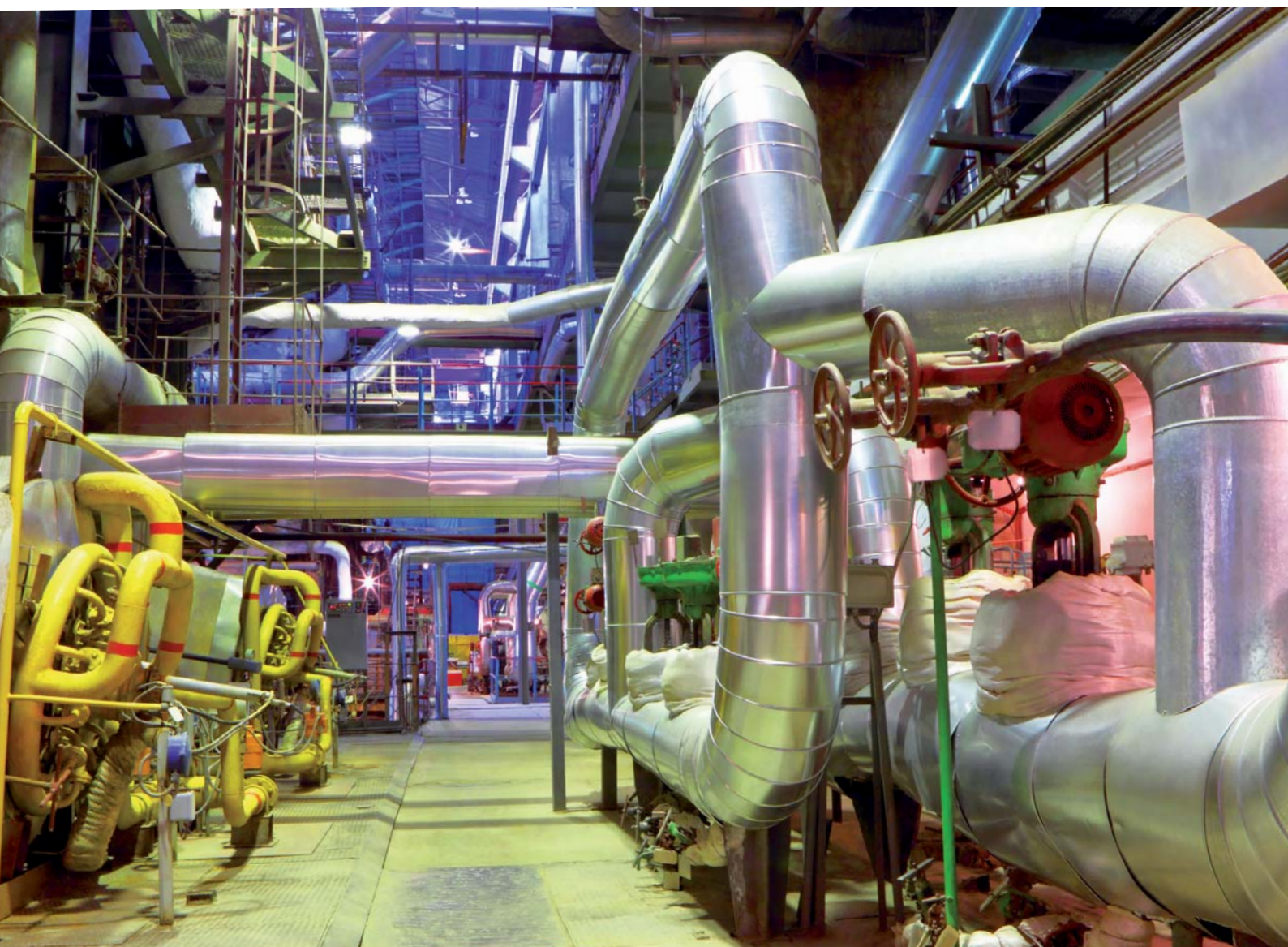



# ELKO EP, Holding

The company ELKO EP has been one of the leading European players in the field of residential and industrial electrical devices for more than 25 years. Since 2007, the company has been developing and producing its own system of Smart Home & Building Solutions called iNELS.

At present, ELKO EP employs nearly 240 people, exports to 70 countries around the world and already has 16 foreign branches. The company is justly proud to produce it's own components, and to have its own development and innovation of new products. It is also able to offer its customers instantaneous distribution and rapid, flawless service. The company became the Company of the Year in 2012 and earned it's place as one of the TOP 100 Czech companies.



# Facts and Stats

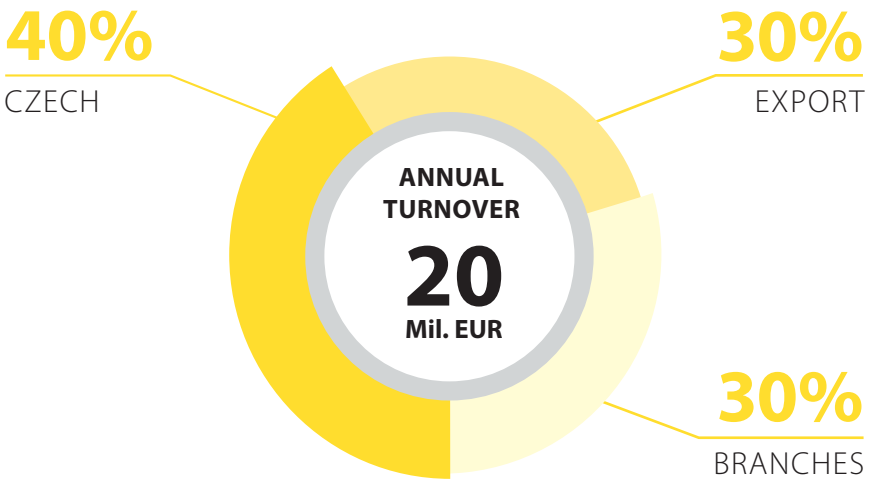

**2<sup>nd</sup> position**  
in Europe

**16**  
BRANCHES  
OVER THE WORLD

**70**  
EXPORTING  
COUNTRIES

**240**  
EMPLOYEES

**5 000**  
iNELS INSTALLATION

**12 000 000**  
MANUFACTURED PRODUCTS



# Product Lines ELKO EP



## RELAYS - Modular electronic devices

A wide range of electronic modular devices, which bring new possibilities to home and office control, monitoring and security, as well as to industrial process control: time relays, installation contactors, staircase automatic switches, time switches clocks, dimmers, thermostats, power supplies units, control and signalling devices, GSM gates, etc.



## iNELS RF Control - Wireless control

A unique wireless control system providing you perfect control over your home! The RF Control system enables you to control functions such as heating, lighting, electrical appliances and window shutters, all with a single touch. No wall cutting, fast and easy installation, exclusive design of wireless wall switch buttons and other components.



## iNELS Air

The new iNELS Air line reacts dynamically with the growing IoT (Internet of Things) network. These networks allow devices to communicate safely, over long distances and optimized to minimize power consumption. The product group includes sensors for communication on the Sigfox and LoRa protocol.



## iNELS BUS SYSTEM - Intelligent electro-installation system

iNELS will transform your house into a timeless intelligent household. It will take charge of heating and air-conditioning, regulation, lighting control and home appliance switching, while also providing perfect security for your home. Enjoy controlling your entire house via a TV screen thanks to iNELS Multimedia (iMM) or use the App for your smartphone or tablet.



## Measuring energy

Measuring and visualization of consumption of energy (electricity, water, gas) for existing buildings, where meters are already installed. Sensing takes place without interference with the meters and data is transferred wirelessly. Displayed in a smartphone application or in a computer from the Cloud.



## Multimedia

In this group you can find products, which brings you a new dimension of controlling music, video and home appliances. These are not just ordinary controllers but products which can be a perfect part of your electro-installation.



## LOGUS<sup>90</sup> - Home switches and sockets

We offer you exclusive switches, sockets and accessories in a standard plastic or metallic design. However, there are also charming luxury frames from purely natural materials such as genuine wood, metal, granite or hardened glass. Be especial!



## ELKO Lighting s.r.o.

We don't only supply LED light sources to the market, but also we bring a complex lighting solution. Our goal is to supply quality and affordable LED light sources and provide a high-level of service - always to satisfy our customers!

# NEW RANGE with new solution



- VOLTAGE
- CURRENT
- GROUND FAULT
- FREQUENCY
- SPEED SENSING
- SYNCHRO CHECK
- REVERSE POWER

7

## REASONS, WHY MONITORING RELAY FROM ELKO EP

- 1 Auxiliary power supply
- 2 Extended power supply 24–240V AC/DC
- 3 Suitable for 50 / 60 Hz networks
- 4 Thanks to newest components, increased measurement accuracy
- 5 Focused on industrial applications
- 6 Bigger range of monitored current / voltage divided to 10 types
- 7 New design

Monitoring relays

Overview of monitoring relays ..... 8

**Voltage monitoring relay**

**Single-phase**

VROU1-28 | Under and over voltage monitoring relays ..... 11

VRU1-28, VRO1-28 | Voltage monitoring relays ..... 12

VRSC1-28 | Synchro-check monitoring relays ..... 14

VRMV1-28 | DC Low voltage monitoring relays ..... 15

**Three-phase**

VROU3-28 | Under and Over voltage monitoring relays ..... 16

VRU3-28 | Under voltage monitoring relays ..... 17

VRO3-28 | Over voltage monitoring relays ..... 18

VROU3N-28 | Under and over voltage monitoring relays ..... 19

VRU3N-28 | Under voltage monitoring relays ..... 20

VRO3N-28 | Over voltage monitoring relays ..... 21

VRSF3-18, VRSF3-28, VRSF3N-18, VRSF3N-28 | Failure and phase sequence monitoring relays ..... 23

VRBU3-18, VRBU3-28, VRBU3N-18, VRBU3N-28 | Phase balance and undervoltage monitoring relays ..... 24

**Current monitoring relay**

**Single-phase**

CROU1-28 | Under and over AC current monitoring relays ..... 26

CRU1-18, CRO1-18 | AC current monitoring relays ..... 27

CRGF1-18 | Ground fault monitoring relays ..... 28

CRMA1-28 | DC Low current monitoring relays ..... 30

CRRP1-28 | Reverse power monitoring relays ..... 32

**Three-phase**

CRRP3-28 | Reverse power monitoring relays ..... 32

CROU3N-28 | Under or over AC current monitoring relays ..... 34

**Frequency monitoring relay**

FROU1-28 | Frequency monitoring relays ..... 35

FRSS1-38 | Speed sensing monitoring relay ..... 36

**Thermistor Trip**

TR1-18 | Motor winding temperature monitoring ..... 38

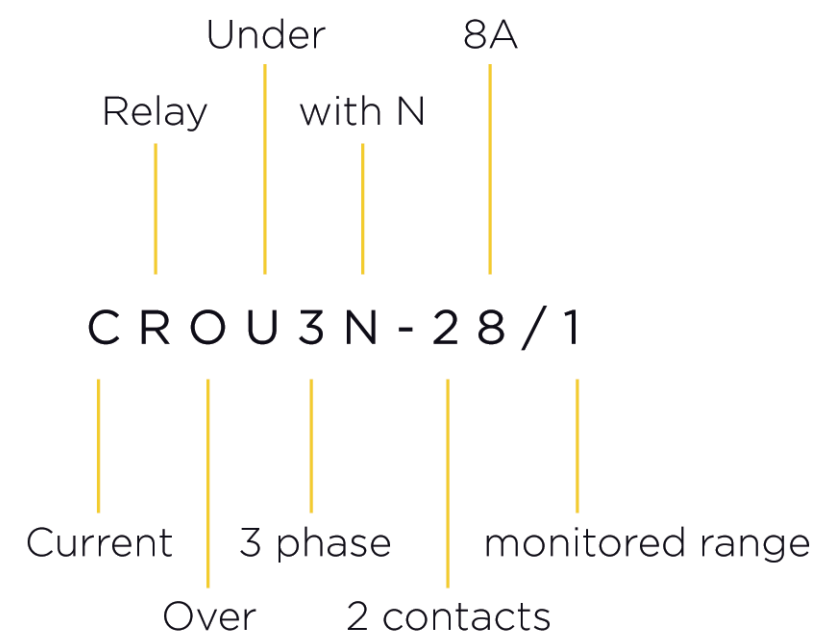
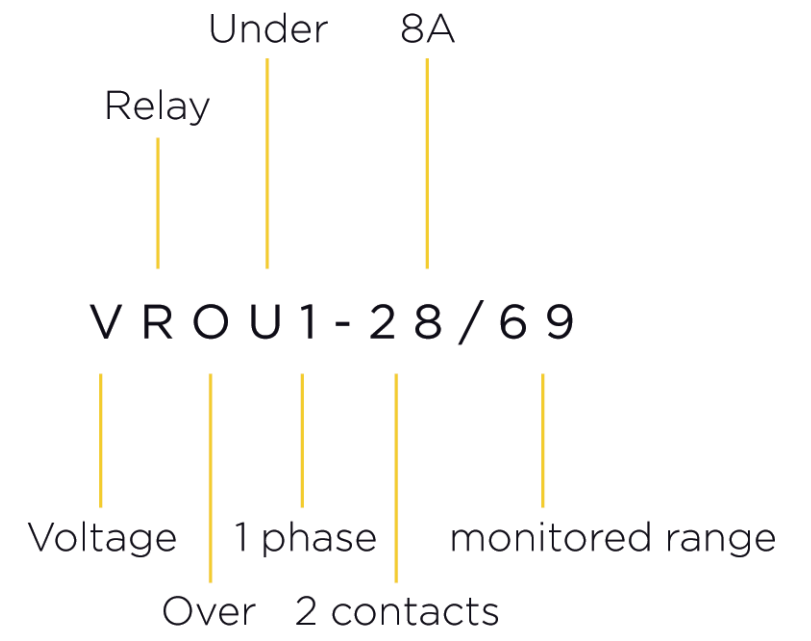



## Voltage monitoring relays - single-phase



**VRU1-28/69**  
**VRU1-28/139**  
**VRU1-28/277**  
 Under voltage monitoring relays

**VRO1-28/69**  
**VRU1-28/139**  
**VRO1-28/277**  
 Over voltage monitoring relays

**VROU1-28/69**  
**VROU1-28/139**  
**VROU1-28/277**  
 Under and over voltage monitoring relays

**VRSC1-28/69**  
**VRSC1-28/139**  
**VRSC1-28/277**  
 Synchro-check monitoring relays

**VRMV1-28/240**  
**VRMV1-28/24**  
 DC Low voltage monitoring relays

## Voltage monitoring relays - three-phase



**VRU3-28/120**  
**VRU3-28/240**  
**VRU3-28/480**  
 Under voltage monitoring relays

**VRO3-28/120**  
**VRO3-28/240**  
**VRO3-28/480**  
 Over voltage monitoring relays

**VROU3-28/120**  
**VROU3-28/240**  
**VROU3-28/480**  
 Under and over voltage monitoring relays

**VRU3N-28/120**  
**VRU3N-28/240**  
**VRU3N-28/480**  
 Under voltage monitoring relays

**VRO3N-28/120**  
**VRO3N-28/240**  
**VRO3N-28/480**  
 Over voltage monitoring relays

**VROU3N-28/120**  
**VROU3N-28/240**  
**VROU3N-28/480**  
 Under and over voltage monitoring relays

**VRSF3-18/120**  
**VRSF3-18/240**  
**VRSF3-28/480**  
 Failure and phase sequence monitoring relays

**VRSF3N-18/120**  
**VRSF3N-18/240**  
**VRSF3N-28/480**  
 Failure and phase sequence monitoring relays

**VRBU3-18/120**  
**VRBU3-18/240**  
**VRBU3-28/480**  
 Phase balance and undervoltage monitoring relays

**VRBU3N-18/120**  
**VRBU3N-18/240**  
**VRBU3N-28/480**  
 Phase balance and undervoltage monitoring relays

## Current monitoring relays - single-phase



**CRU1-18/1**  
**CRU1-18/5**  
 Under AC current monitoring relays

**CRO1-18/1**  
**CRO1-18/5**  
 Over AC current monitoring relays

**CROU1-28/1**  
**CROU1-28/5**  
 Under and over AC current monitoring relays

**CRGF1-18/24**  
**CRGF1-18/240**  
 Ground fault monitoring relays

**CRMA1-28/24**  
**CRMA1-28/240**  
 DC low current monitoring relays

**CRRP1-28/120**  
**CRRP1-28/240**  
**CRRP1-28/480**  
 Reverse power monitoring relays

## Current monitoring relays - three-phase



**CRRP3-28/120**  
**CRRP3-28/240**  
**CRRP3-28/480**  
 Reverse power monitoring relays

**CROU3N-28/1**  
**CROU3N-28/5**  
 Under or over AC current monitoring relays

## Frequency monitoring relays



**FROU1-28/87**  
**FROU1-28/174**  
 Frequency monitoring relays

**FROU1-28/346**  
**FROU1-28/500**  
 Frequency monitoring relays

**FRSS1-38/130**  
 Speed sensing/monitoring relay

## Thermistor Trip



**TR1-18/3,3**  
 Motor winding temperature monitoring



EAN code  
 VROU1-28/69: 8595188155274  
 VROU1-28/139: 8595188155281  
 VROU1-28/277: 8595188155298

Technical parameters	VROU1-28/69	VROU1-28/139	VROU1-28/277
Nominal voltage range (Un):	57.7-69.3 V	100-139 V L-N	220-277 V
Overload capacity			
- continuous:	87 V	174 V	346 V
- 10 s max:	104 V	209 V	416 V
Operating frequency:		45-65 Hz	
Auxiliary Supply Voltage:		24 V - 240 V AC/DC	
AC Supply frequency:		45-65 Hz	
Supply voltage tolerance:		±10%	
Auxiliary Voltage Burden (Max):		3 VA / 1.2 W	
Over-voltage range (Umax):		100-125 %Un	
Under-voltage range (Umin):		75-100 %Un	
Differential:		Adjustable 1-15 %Un	
Trip time delay:		Adjustable 0.5 to 10s	
Relay contacts:		2 x changeover, volt-free, for general switching operations	
Load capacity - AC:		250 V @ 8 A, 2 kVA	
Load capacity - DC:		30 V 8A	
Insulation:		4 kV/1 min	
Mechanical endurance:		30 x 10 <sup>6</sup> operations	
<b>Other Data</b>			
Dimensions:		90 x 52 x 64 mm	
Weight:		138 g	
Maximum conductor size:		2 x 1.5 mm <sup>2</sup> or 1 x 2.5 mm <sup>2</sup>	
Operating temperature:		-20 to +55 °C	
Storage temperature:		-30 to +70 °C	
Over-voltage category:		III	
Pollution degree:		2	
Environmental protection:		IP40 for front panel, IP20 for terminals	
Standards:		EN 60255-6, EN 60255-27, EN 61000-6-2, EN 61000-6-4	

- These units monitor a single phase supply and operate relays if the phase voltage goes below or above set levels. Front panel controls allow selection of:
  - Under- and Over-voltage trip levels,
  - nominal rated voltage,
  - differential voltage for operating hysteresis and
  - time delay before a trip triggers a relay response.
- LEDs indicate power on and trip status. A relay with two changeover volt-free contacts is fitted.
- These instructions contain important safety information. Please read them thoroughly before commissioning, operating or maintenance of the unit.

**Device description**

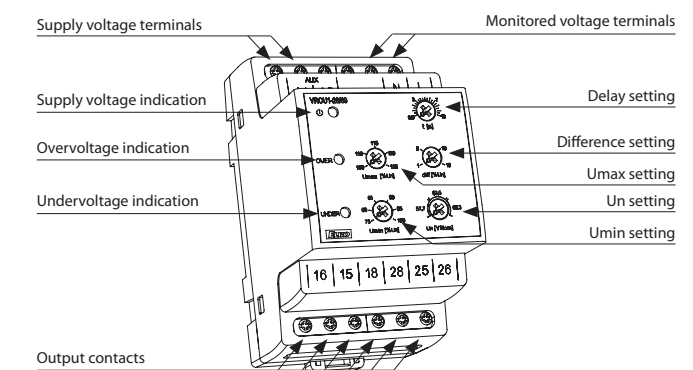

**Function**

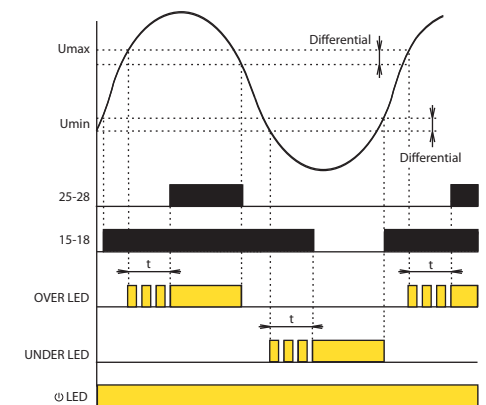

The time delay and differential trip levels help to prevent relay chatter as the monitored voltage level varies.

As the relays have changeover contacts, the relay outputs can be inverted by wiring to the alternative terminals 15-16 or 25-26.

The unit obtains its power from the separate auxiliary supply. The green LED lights to show when this supply is present.

Under normal conditions, with voltage at nominal level, both red LEDs will be off, the Under relay will be energised and the Over relay will be de-energised. With mains supply off, both relays will be de-energised.

**Under-voltage Operation**

If the monitored phase voltage goes below the set under-voltage level (Umin), the Under LED will light and the Under relay (15-16/18) will deenergise after the set delay. During the delay period, the Under LED will flash.

If the voltage then returns above Umin plus the differential value, the Under LED will go off and the Under relay will energise again, without delay.

**Over-voltage Operation**

If the monitored phase voltage goes above the set over-voltage level (Umax), the Over LED will light and the Over relay (25-26/28) will energise after the set delay. During the delay period, the Over LED will flash.

If the voltage then falls below Umax minus the differential value, the Over relay will de-energise and the Over LED will go off, without delay.

**Connection**

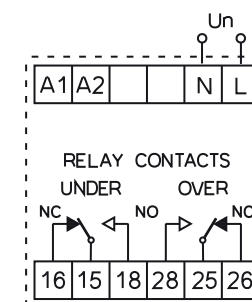



EAN code  
 VRU1-28/69: 8595188154437 VRO1-28/69: 8595188154406  
 VRU1-28/139: 8595188154444 VRO1-28/139: 8595188154413  
 VRU1-28/277: 8595188154451 VRO1-28/277: 8595188154420

Technical parameters	69	139	277
Nominal voltage range (Un):	57.7-69.3 V	100-139 V	220-277 V
		L-N	
Overload capacity			
- continuous:	87 V	174 V	346 V
- 10 s max:	104 V	209 V	416 V
Operating frequency:	45-65 Hz		
Auxiliary Supply Voltage:	24 V - 240 V AC/DC		
AC Supply frequency:	45-65 Hz		
Supply voltage tolerance:	±10%		
Auxiliary Voltage Burden (Max):	3 VA / 1.2 W		
Over-voltage range (Umax):	100-125 %Un (VRO1-28)		
Under-voltage range (Umin):	75-100 %Un (VRU1-28)		
Differential:	Adjustable 1-15 %Un		
Trip time delay:	Adjustable 0.5 to 10s		
Relay contacts:	2 x changeover, volt-free, for general switching operations		
Load capacity - AC:	250 V @ 8 A, 2 kVA		
Load capacity - DC:	30 V 8A		
Insulation:	4 kV/1 min		
Mechanical endurance:	30 x 10 <sup>6</sup> operations		
<b>Other Data</b>			
Dimensions:	90 x 52 x 64 mm		
Weight:	138 g		
Maximum conductor size:	2 x 1.5 mm <sup>2</sup> or 1 x 2.5 mm <sup>2</sup>		
Operating temperature:	-20 to +55 °C		
Storage temperature:	-30 to +70 °C		
Over-voltage category:	III		
Pollution degree:	2		
Environmental protection:	IP40 for front panel, IP20 for terminals		
Standards:	EN 60255-6, EN 60255-27, EN 61000-6-2, EN 61000-6-4		

Connection

VRU1-28

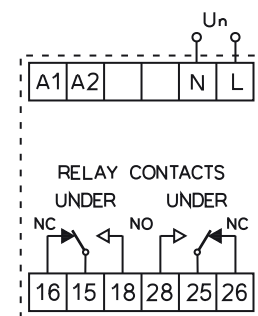

VRO1-28

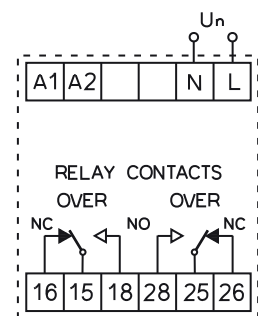

- These units monitor a single phase supply and operate relays if the phase voltage goes below or above set levels. Front panel controls allow selection of:
  - Under (VRU1-28)- and Over- (VRO1-28) voltage trip levels,
  - nominal rated voltage,
  - differential voltage for operating hysteresis and
  - time delay before a trip triggers a relay response.
- LEDs indicate power on and trip status. A relay with two changeover volt-free contacts is fitted.
- These instructions contain important safety information. Please read them thoroughly before commissioning, operation or maintenance of the unit.

Device description

VRU1-28

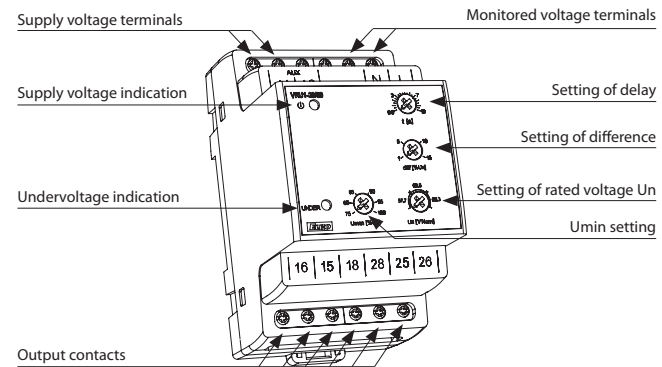

VRO1-28

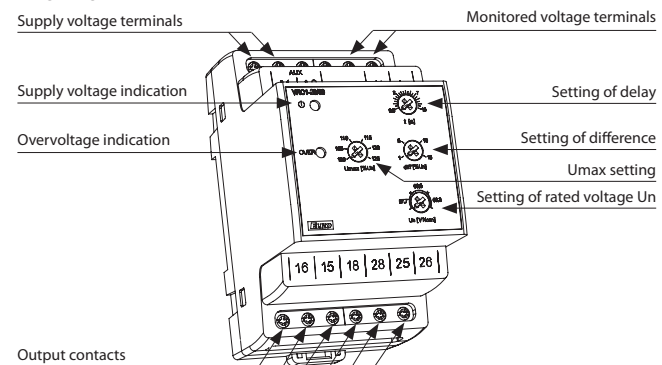

Function

VRU1-28

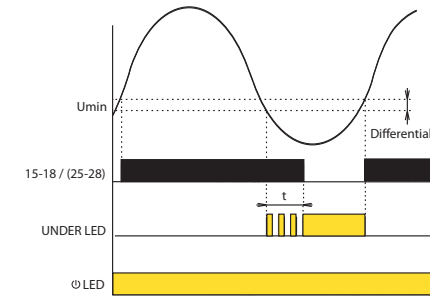

VRO1-28

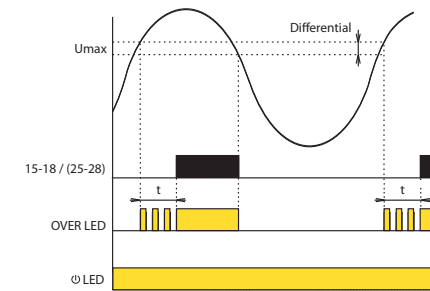

The time delay and differential trip levels help to prevent relay chatter as the monitored voltage level varies. As the relays have changeover contacts, the relay outputs can be inverted by wiring to the alternative terminals 15-16 or 25-26.

The unit obtains its power from the separate auxiliary supply. The green LED lights to show when this supply is present.

Under-voltage Mode (Model VRU1-28)

If the monitored phase voltage goes below the set under-voltage level (Umin), the Under LED will light and relay (15-16/18) & (25-26/28) will de-energise after the set delay. During the delay period, the Under LED will flash. If the voltage then returns above Umin plus the differential value, the Under LED will go off and the Under relay will energise again, without delay.

Over-voltage Mode (Model VRO1-28)

If the monitored phase voltage goes above the set over-voltage level (Umax), the Over LED will light and relay (15-16/18) & (25-26/28) will energise after the set delay. During the delay period, the Over LED will flash. If the voltage then falls below Umax minus the differential value, the Over relay will de-energise and the Over LED will go off, without delay.





EAN code  
 VRSC1-28/69: 8595188142250  
 VRSC1-28/139: 8595188142267  
 VRSC1-28/277: 8595188142274

Technical parameters	VRSC1-28/69	VRSC1-28/139	VRSC1-28/277
Rated Vg range Un:	57-69 V	100-139 V	220-277 V
Overload capacity			
- continuous:	87 V	174 V	346 V
- 10s max.:	104 V	209 V	416 V
Minimum supply Vg Uon:	35 V	60 V	132 V
Burden on supply (Max):	2 VA / 1.6W	2.7 VA / 1.7W	4 VA / 2.2W
Frequency range:	45-65 Hz		
Deadbus on Udbon:	25% Uon		
Deadbus off Udboff:	50% Uon		
Sync Tolerance:	10-30% Volts		
Relay contacts:	2 x changeover, volt-free, for general switching operations		
Load capacity - AC:	250 V @ 8 A, 2 kVA		
Load capacity - DC:	30 V 8A		
Insulation:	4 kV/1 min		
Mechanical endurance:	30 x 10 <sup>6</sup> operations		

Other Data			
Dimensions:	90 x 105 x 64 mm		
Weight:	291 g	335 g	332 g
Maximum conductor size:	2 x 1.5 mm <sup>2</sup> or 1 x 2.5 mm <sup>2</sup>		
Operating temperature:	-20 to +55 °C		
Storage temperature:	-30 to +70 °C		
Over-voltage category:	III		
Pollution degree:	2		
Environmental protection:	IP40 for front panel, IP20 for terminals		
Standards:	EN 60255-6, EN 60255-27, EN 61000-6-2, EN 61000-6-4		

Connection

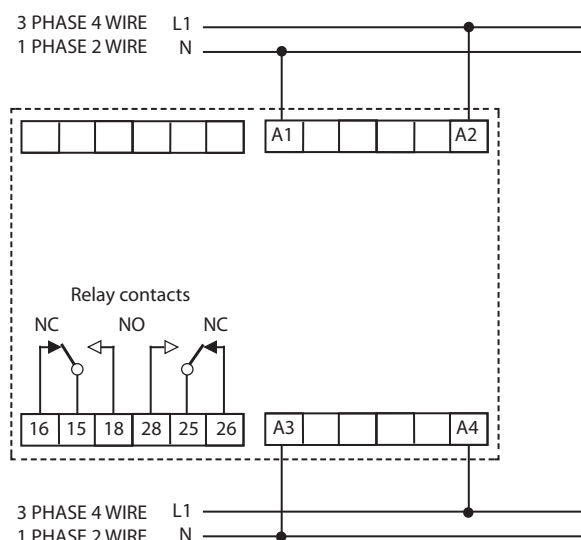

- This unit compares the voltage, frequency and phase angle of two supplies and operates a relay according to the synchronicity of the supplies. If the two supplies cease to match, the relay operates to provide a control output. The relay output can be used for alarm or control purposes.
- The unit also provides a dead bus function. If the bus supply fails, the relay operates and the output can be used to switch in an emergency generator. LEDs indicate power on, relay and dead bus status.
- Controls on the front panel set the trip points at which the relays and LEDs operate:
  - Degree of synchronicity Ux (%Volts)
  - Nominal voltage (Un)
  - Dead bus function on/off
- The unit is powered from the generator supply.
- These instructions contain important safety information. Please read them thoroughly before commissioning, operating or maintenance of the unit.

Device description

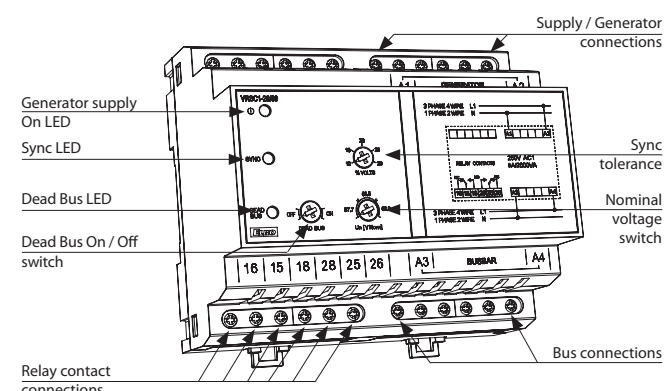

Function

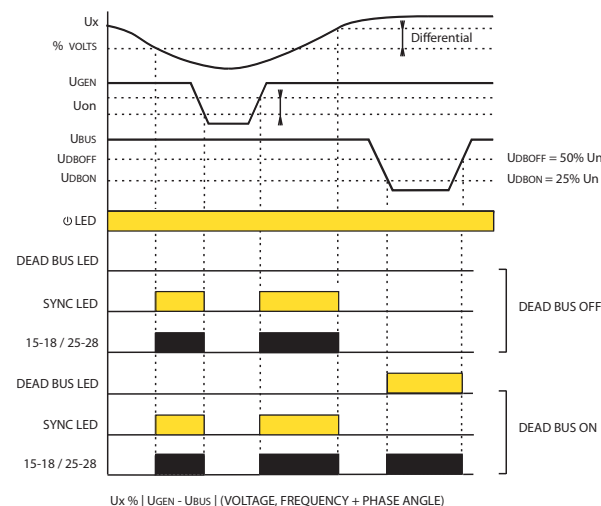

The differential trip levels help to prevent relay chatter as the monitored voltage level varies.

As the relays have changeover contacts, the relay outputs can be inverted by wiring to the alternative terminals 15-16 or 25-26.

The green LED lights shows when the power supply is on.

While the two supplies match in voltage, frequency and phase to the degree set by the %Volts control, the Sync LED lights and the relay is energised.

If one supply varies such that they no longer match to that degree, the Sync LED goes off and the relay de-energises.

If the generator voltage falls below the Uon level, the unit ceases to operate, the relay de-energises and the Sync LED goes off.

With Dead Bus On, if the bus voltage falls below the Udbon level, the relay energises and the Dead Bus LED lights. The relay can be used to turn on an emergency supply in the event of bus supply failure. The relay will de-energise again and the LED will go off when the bus voltage rises above the Udboff level.



EAN code  
 VRMV1-28/240: 8595188145695  
 VRMV1-28/24: 8595188144872

Technical parameters	VRMV1-28/24	VRMV1-28/240
Supply voltage:	12-24V DC	24V-240V AC/DC
Burden on supply:	1W	3VA/0.9W
AC Supply frequency:	45-65 Hz	
Supply voltage tolerance:	±10%	
Rated DC voltage Uin:	50mV, 75 mV, 100 mV	
Input impedance:	50 kΩ	
Over-voltage range (Umax):	40-120 % Uin	
Under-voltage range (Umin):	0-80 % Uin	
Overload capacity:	10 x Uin	
Differential:	Fixed at 1% Uin	
Trip time delay:	Adjustable 0.5 to 10s	
Relay contacts:	2 x changeover, volt-free, for general switching operations	
Load capacity - AC:	250 V @ 8 A, 2 kVA	
Load capacity - DC:	30 V 8A	
Insulation:	4 kV/1 min	
Mechanical endurance:	30 x 10 <sup>6</sup> operations	

Other Data	
Dimensions:	90 x 52 x 64 mm
Weight:	135 g
Maximum conductor size:	2 x 1.5 mm <sup>2</sup> or 1 x 2.5 mm <sup>2</sup>
Operating temperature:	-20 to +55 °C
Storage temperature:	-30 to +70 °C
Over-voltage category:	III
Pollution degree:	2
Environmental protection:	IP40 for front panel, IP20 for terminals
Standards:	EN 60255-6, EN 60255-27, EN 61000-6-2, EN 61000-6-4

Connection

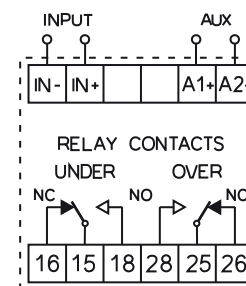

- These units monitor a voltage of 50, 75 or 150 mV, e.g. from a standard current shunt, and operates one of two relays if the voltage goes above or below set levels. Front panel controls allow selection of:
  - under- and over-voltage trip levels Umax, Umin
  - nominal rated voltage of 50, 75 or 100 mV (Uin)
  - time delay before a trip triggers a relay response.
- LEDs indicate power on and trip status. Two changeover, volt-free relays are fitted.
- Two types are available - a 12-24 unit powered from 12-24V DC and a 24-240 unit powered from 24V-240V AC or DC
- These instructions contain important safety information. Please read them thoroughly before commissioning, operating or maintenance of the unit.

Device description

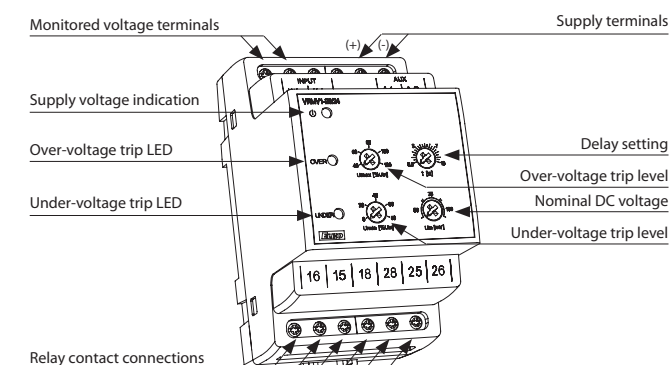

Function

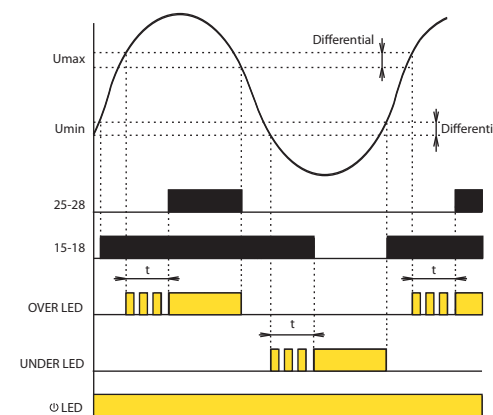

The time delay and differential trip levels help to prevent relay chatter as the monitored voltage level varies.

As the relays have changeover contacts, the relay outputs can be inverted by wiring to the alternative terminals 15-16 or 25-26.

The green LED lights to shows when the supply is present.

Under normal conditions, with the monitored voltage at nominal levels, both red LEDs will be off, the Under relay will be energised and the Over relay will be de-energised. With supply voltage off, both relays will be de-energised.

Under-voltage Operation

If the monitored voltage goes below the set under-voltage level (Umin), the Under LED will light and the Under relay (15-16/18) will de-energise after the set delay. During the delay period, the Under LED will flash.

If the voltage then returns above Umin plus the differential value, the Under LED will go off and the Under relay will energise again, without delay.

Over-voltage Operation

If the monitored voltage goes above the set over-voltage level (Umax), the Over LED will light and the Over relay (25-26/28) will energise after the set delay. During the delay period, the Over LED will flash.

If the voltage then falls below Umax minus the differential value, the Over relay will de-energise and the Over LED will go off, without delay.





EAN code  
VROU3-28/120: 8595188155304  
VROU3-28/240: 8595188155311  
VROU3-28/480: 8595188155328

Technical parameters	VROU3-28/120	VROU3-28/240	VROU3-28/480
Nominal voltage range (Un):	100-120 V	173-240 V	380-480 V
Overload capacity			
- continuous:	150 V	300 V	600 V
- 10 s max:	180 V	360 V	720 V
Operating frequency:	45-65 Hz		
Auxiliary Supply Voltage:	24 V - 240 V AC/DC		
AC Supply frequency:	45-65 Hz		
Supply voltage tolerance:	±10%		
Auxiliary Voltage Burden (Max):	3 VA / 1.2 W		
Over-voltage range (Umax):	100-125 %Un		
Under-voltage range (Umin):	75-100 %Un		
Differential:	Adjustable 1-15 %Un		
Trip time delay:	Adjustable 0.5 to 10s		
Relay contacts:	2 x changeover, volt-free, for general switching operations		
Load capacity - AC:	250 V @ 8 A, 2 kVA		
Load capacity - DC:	30 V 8A		
Insulation:	4 kV/1 min		
Mechanical endurance:	30 x 10 <sup>6</sup> operations		

Other Data	
Dimensions:	90 x 52 x 64 mm
Weight:	138 g
Maximum conductor size:	2 x 1.5 mm <sup>2</sup> or 1 x 2.5 mm <sup>2</sup>
Operating temperature:	-20 to +55 °C
Storage temperature:	-30 to +70 °C
Over-voltage category:	III
Pollution degree:	2
Environmental protection:	IP40 for front panel, IP20 for terminals
Standards:	EN 60255-6, EN 60255-27, EN 61000-6-2, EN 61000-6-4

Connection

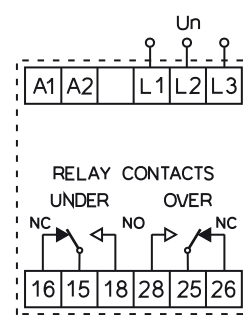

- These units monitor a 3-phase 3-wire supply and operate relays if a phase-phase voltage goes below or above set levels. Front panel controls allow selection of:
  - Under- and Over-voltage trip levels,
  - nominal rated voltage,
  - differential voltage for operating hysteresis and
  - time delay before a trip triggers a relay response.
- LEDs indicate power on and trip status. A relay with two changeover volt-free contacts is fitted.
- These instructions contain important safety information. Please read them thoroughly before commissioning, operation or maintenance of the unit.

Device description

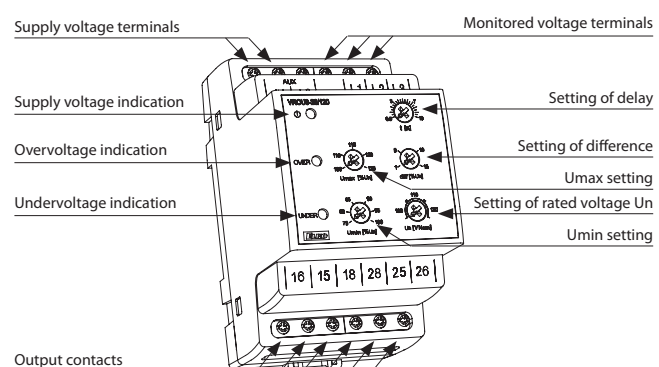

Function

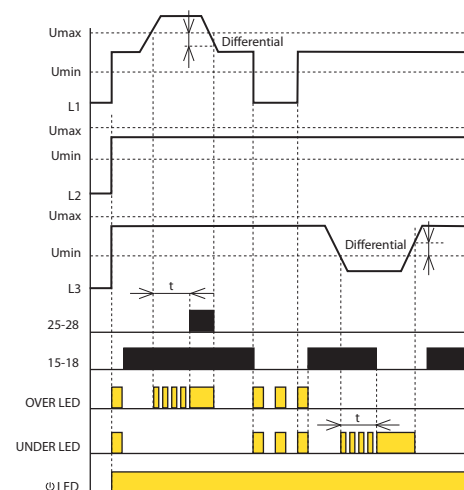

The time delay and differential trip levels help to prevent relay chatter as the monitored voltage level varies.

As the relays have changeover contacts, the relay outputs can be inverted by wiring to the alternative terminals 15-16 or 25-26.

The unit obtains its power from the separate auxiliary supply.

The green LED lights to shows when this supply is present.

Under normal conditions, with all three phases at nominal level, both red LEDs will be off, the Under relay will be energised and the Over relay will be de-energised. With mains supply off, both relays will be de-energised.

Under-voltage Mode

If the monitored voltage of any phase goes below the set under-voltage level (Umin), the Under LED will light and the Under relay (15-16/18) will de-energise after the set delay. During the delay period, the Under LED will flash. If the voltage then returns above Umin plus the differential value, the Under LED will go off and the Under relay will energise again, without delay.

Over-voltage Mode

If the monitored voltage of any phase goes above the set over-voltage level (Umax), the Over LED will light and the Over relay (25-26/28) will energise after the set delay. During the delay period, the Over LED will flash. If the voltage then falls below Umax minus the differential value, the Over relay will de-energise and the Over LED will go off, without delay.



EAN code  
VRU3-28/120: 8595188154376  
VRU3-28/240: 8595188154383  
VRU3-28/480: 8595188154390

Technical parameters	VRU3-28/120	VRU3-28/240	VRU3-28/480
Nominal voltage range (Un):	100-120 V	173-240 V	380-480 V
Overload capacity			
- continuous:	150 V	300 V	600 V
- 10 s max:	180 V	360 V	720 V
Operating frequency:	45-65 Hz		
Auxiliary Supply Voltage:	24 V - 240 V AC/DC		
AC Supply frequency:	45-65 Hz		
Supply voltage tolerance:	±10%		
Auxiliary Voltage Burden (Max):	3 VA / 1.2 W		
Under-voltage range (Umin):	75-100 %Un		
Differential:	Adjustable 1-15 %Un		
Trip time delay:	Adjustable 0.5 to 10s		
Relay contacts:	2 x changeover, volt-free, for general switching operations		
Load capacity - AC:	250 V @ 8 A, 2 kVA		
Load capacity - DC:	30 V 8A		
Insulation:	4 kV/1 min		
Mechanical endurance:	30 x 10 <sup>6</sup> operations		

Other Data	
Dimensions:	90 x 52 x 64 mm
Weight:	138 g
Maximum conductor size:	2 x 1.5 mm <sup>2</sup> or 1 x 2.5 mm <sup>2</sup>
Operating temperature:	-20 to +55 °C
Storage temperature:	-30 to +70 °C
Over-voltage category:	III
Pollution degree:	2
Environmental protection:	IP40 for front panel, IP20 for terminals
Standards:	EN 60255-6, EN 60255-27, EN 61000-6-2, EN 61000-6-4

Connection

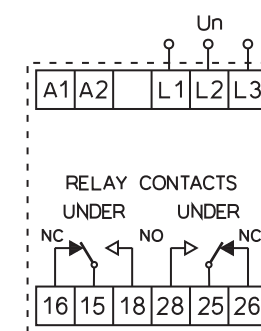

- These units monitor a 3-phase 3-wire supply and operate relays if a phase-phase voltage goes below set levels. Front panel controls allow selection of:
  - Under voltage trip levels,
  - nominal rated voltage,
  - differential voltage for operating hysteresis and
  - time delay before a trip triggers a relay response.
- LEDs indicate power on and trip status. A relay with two changeover volt-free contacts is fitted.
- These instructions contain important safety information. Please read them thoroughly before commissioning, operation or maintenance of the unit.

Device description

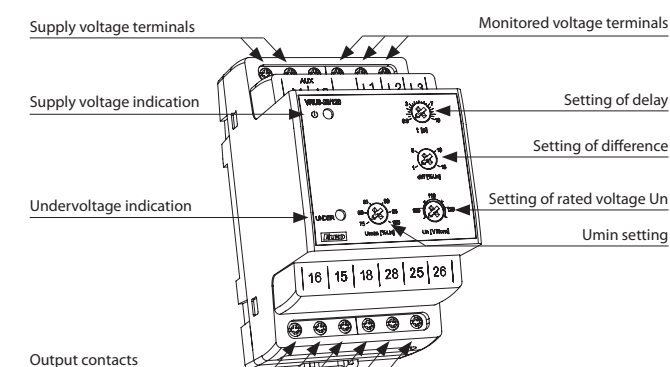

Function

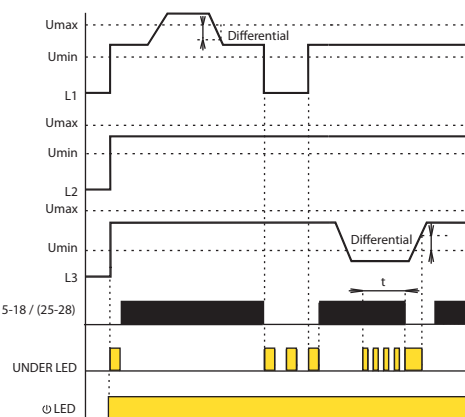

The time delay and differential trip levels help to prevent relay chatter as the monitored voltage level varies.

As the relays have changeover contacts, the relay outputs can be inverted by wiring to the alternative terminals 15-16 or 25-26.

The unit obtains its power from the separate auxiliary supply.

The green LED lights to shows when this supply is present.

Under normal conditions, with all three voltages at nominal level, the red LED will be off, the Under relay will be energised. With mains supply off the relay will be de-energised.

Under-voltage Operation

If the monitored voltage of any phase goes below the set under-voltage level (Umin), the Under LED will light and the Under relay (15-16/18) & (25-26/28) will de-energise after the set delay. During the delay period, the Under LED will flash.

If the voltage then returns above Umin plus the differential value, the Under LED will go off and the Under relay will energise again, without delay.



EAN code  
 VRO3-28/120: 8595188155243  
 VRO3-28/240: 8595188155250  
 VRO3-28/480: 8595188155267

Technical parameters	VRO3-28/120	VRO3-28/240	VRO3-28/480
Nominal voltage range (Un):	100-120 V	173-240 V	380-480 V
Overload capacity		L-L	
- continuous:	150 V	300 V	600 V
- 10 s max:	180 V	360 V	720 V
Operating frequency:		45-65 Hz	
Auxiliary Supply Voltage:		24 V - 240 V AC/DC	
AC Supply frequency:		45-65 Hz	
Supply voltage tolerance:		±10%	
Auxiliary Voltage Burden (Max):		3 VA / 1.2 W	
Over-voltage range (Umax):		100-125 %Un	
Differential:		Adjustable 1-15 %Un	
Trip time delay:		Adjustable 0.5 to 10s	
Relay contacts:		2 x changeover, volt-free, for general switching operations	
Load capacity - AC:		250 V @ 8 A, 2 kVA	
Load capacity - DC:		30 V 8A	
Insulation:		4 kV/1 min	
Mechanical endurance:		30 x 10 <sup>6</sup> operations	
<b>Other Data</b>			
Dimensions:	90 x 52 x 64 mm		
Weight:	138 g		
Maximum conductor size:	2 x 1.5 mm <sup>2</sup> or 1 x 2.5 mm <sup>2</sup>		
Operating temperature:	-20 to +55 °C		
Storage temperature:	-30 to +70 °C		
Over-voltage category:	III		
Pollution degree:	2		
Environmental protection:	IP40 for front panel, IP20 for terminals		
Standards:	EN 60255-6, EN 60255-27, EN 61000-6-2, EN 61000-6-4		

**Connection**

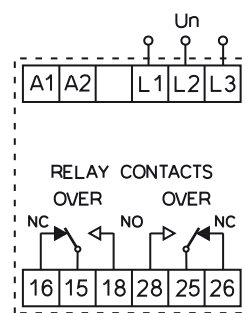

- These units monitor a 3-phase 3-wire supply and operate relays if a phase-phase voltage goes below set levels. Front panel controls allow selection of:
  - Over voltage trip levels,
  - nominal rated voltage,
  - differential voltage for operating hysteresis and
  - time delay before a trip triggers a relay response.
- LEDs indicate power on and trip status. A relay with two changeover volt-free contacts is fitted.
- These instructions contain important safety information. Please read them thoroughly before commissioning, operation or maintenance of the unit.

**Device description**

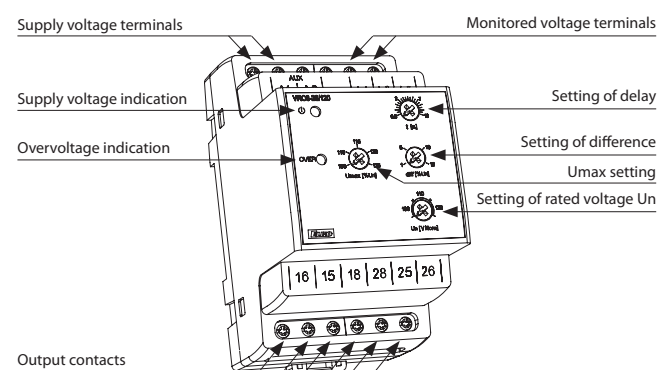

**Function**

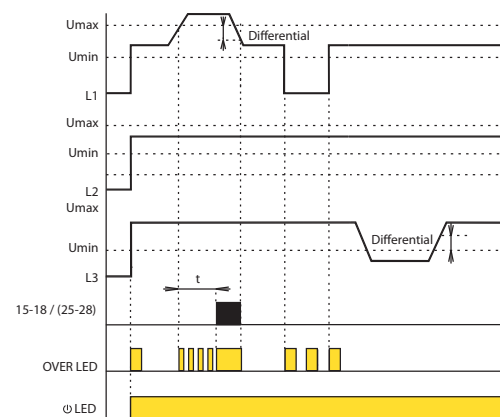

The time delay and differential trip levels help to prevent relay chatter as the monitored voltage level varies.

As the relays have changeover contacts, the relay outputs can be inverted by wiring to the alternative terminals 15-16 or 25-26.

The unit obtains its power from the separate auxiliary supply. The green LED lights to shows when this supply is present.

Over normal conditions, with all three voltages at nominal level, the red LED will be off, the Over relay will be de-energised. With mains supply off the relay will be de-energised.

**Over-voltage Mode**

If the monitored voltage of any phase goes above the set over-voltage level (Umax), the Over LED will light and the Over relay (15-16/18) & (25-26/28) will energise after the set delay. During the delay period, the Over LED will flash.

If the voltage then falls below Umax minus the differential value, the Over relay will de-energise and the Over LED will go off, without delay.



EAN code  
 VROU3N-28/120: 8595188154345  
 VROU3N-28/240: 8595188154352  
 VROU3N-28/480: 8595188154369

Technical parameters	VROU3N-28/120	VROU3N-28/240	VROU3N-28/480
Nominal voltage range (Un):	57.7-69.3 V	100-139 V	220-277 V
Overload capacity		L-N	
- continuous:	87 V	174 V	346 V
- 10 s max:	104 V	209 V	416 V
Operating frequency:		45-65 Hz	
Auxiliary Supply Voltage:		24 V - 240 V AC/DC	
AC Supply frequency:		45-65 Hz	
Supply voltage tolerance:		±10 %	
Auxiliary Voltage Burden (Max):		3 VA / 1.2 W	
Over-voltage range (Umax):		100-130 %Un	
Under-voltage range (Umin):		70-100 %Un	
Differential:		Adjustable 1-15 %Un	
Trip time delay:		Adjustable 0.5 to 10s	
Relay contacts:		2 x changeover, volt-free, for general switching operations	
Load capacity - AC:		250 V @ 8 A, 2 kVA	
Load capacity - DC:		30 V 8A	
Insulation:		4 kV/1 min	
Mechanical endurance:		30 x 10 <sup>6</sup> operations	
<b>Other Data</b>			
Dimensions:	90 x 52 x 64 mm		
Weight:	138 g		
Maximum conductor size:	2 x 1.5 mm <sup>2</sup> or 1 x 2.5 mm <sup>2</sup>		
Operating temperature:	-20 to +55 °C		
Storage temperature:	-30 to +70 °C		
Over-voltage category:	III		
Pollution degree:	2		
Environmental protection:	IP40 for front panel, IP20 for terminals		
Standards:	EN 60255-6, EN 60255-27, EN 61000-6-2, EN 61000-6-4		

**Connection**

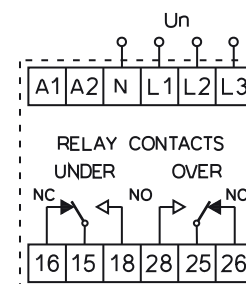

- These units monitor a 3-phase 4-wire supply and operate relays if a phase-neutral voltage goes below or above set levels. Front panel controls allow selection of:
  - Under- and Over-voltage trip levels,
  - nominal rated voltage,
  - differential voltage for operating hysteresis and
  - time delay before a trip triggers a relay response.
- LEDs indicate power on and trip status. A relay with two changeover volt-free contacts is fitted.
- These instructions contain important safety information. Please read them thoroughly before commissioning, operation or maintenance of the unit.

**Device description**

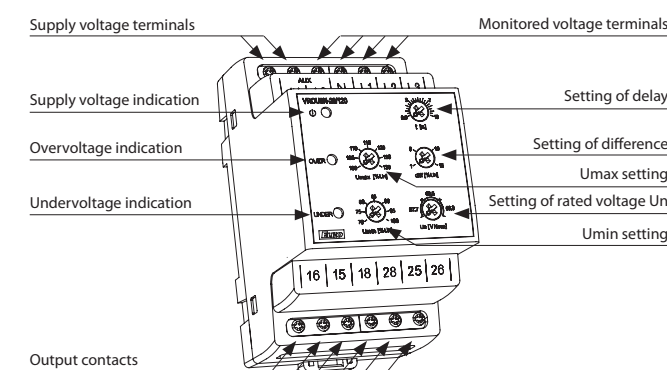

**Function**

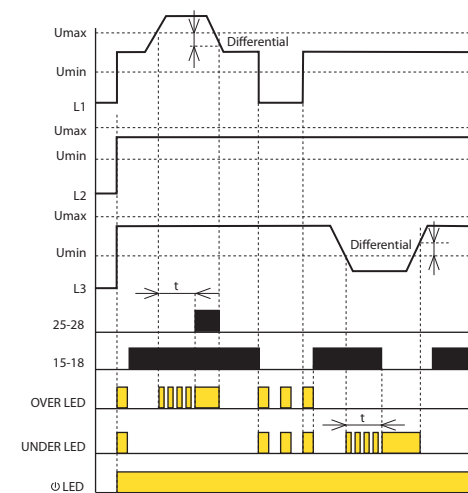

The time delay and differential trip levels help to prevent relay chatter as the monitored voltage level varies.

As the relays have changeover contacts, the relay outputs can be inverted by wiring to the alternative terminals 15-16 or 25-26.

The unit obtains its power from the separate auxiliary supply. The green LED lights to shows when this supply is present.

Under normal conditions, with all three phases at nominal level, both red LEDs will be off, the Under relay will be energised and the Over relay will be de-energised. With mains supply off, both relays will be de-energised.

**Under-voltage Mode**

If the monitored voltage of any phase goes below the set under-voltage level (Umin), the Under LED will light and the Under relay (15-16/18) will de-energise after the set delay. During the delay period, the Under LED will flash.

If the voltage then returns above Umin plus the differential value, the Under LED will go off and the Under relay will energise again, without delay.

**Over-voltage Mode**

If the monitored voltage of any phase goes above the set over-voltage level (Umax), the Over LED will light and the Over relay (25-26/28) will energise after the set delay. During the delay period, the Over LED will flash.

If the voltage then falls below Umax minus the differential value, the Over relay will de-energise and the Over LED will go off, without delay.



EAN code  
VRU3N-28/120: 8595188154468  
VRU3N-28/240: 8595188154475  
VRU3N-28/480: 8595188154482

Technical parameters	VRU3N-28/120	VRU3N-28/240	VRU3N-28/480
Nominal voltage range (Un):	57.7-69.3 V	100-139 V	220-277 V
	L-N		
Overload capacity			
- continuous:	87 V	174 V	346 V
- 10 s max:	104 V	209 V	416 V
Operating frequency:	45-65 Hz		
Auxiliary Supply Voltage:	24 V - 240 V AC/DC		
AC Supply frequency:	45-65 Hz		
Supply voltage tolerance:	±10%		
Auxiliary Voltage Burden (Max):	3 VA / 1.2 W		
Under-voltage range (Umin):	70-100 %Un		
Differential:	Adjustable 1-15 %Un		
Trip time delay:	Adjustable 0.5 to 10s		
Relay contacts:	2 x changeover, volt-free, for general switching operations		
Load capacity - AC:	250 V @ 8 A, 2 kVA		
Load capacity - DC:	30 V 8A		
Insulation:	4 kV/1 min		
Mechanical endurance:	30 x 10 <sup>6</sup> operations		
<b>Other Data</b>			
Dimensions:	90 x 52 x 64 mm		
Weight:	138 g		
Maximum conductor size:	2 x 1.5 mm <sup>2</sup> or 1 x 2.5 mm <sup>2</sup>		
Operating temperature:	-20 to +55 °C		
Storage temperature:	-30 to +70 °C		
Over-voltage category:	III		
Pollution degree:	2		
Environmental protection:	IP40 for front panel, IP20 for terminals		
Standards:	EN 60255-6, EN 60255-27, EN 61000-6-2, EN 61000-6-4		

#### Connection

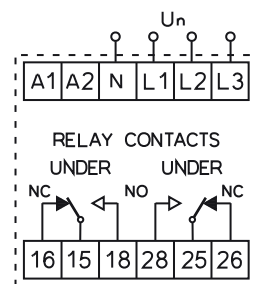

- These units monitor a 3-phase 4-wire supply and operate relays if a phase-neutral voltage goes below set levels. Front panel controls allow selection of:
  - Under voltage trip levels,
  - nominal rated voltage,
  - differential voltage for operating hysteresis and
  - time delay before a trip triggers a relay response.
- LEDs indicate power on and trip status. A relay with two changeover volt-free contacts is fitted.
- These instructions contain important safety information. Please read them thoroughly before commissioning, operation or maintenance of the unit.

#### Device description

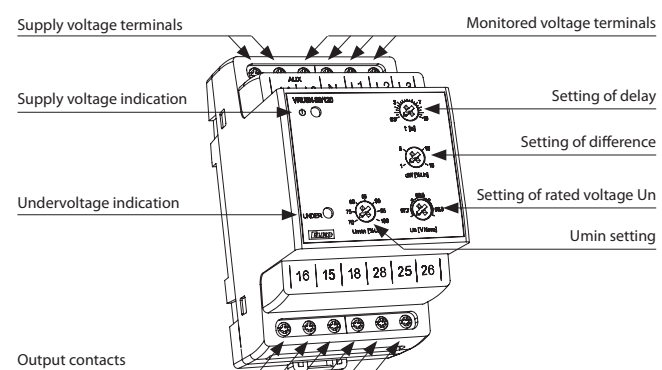

#### Function

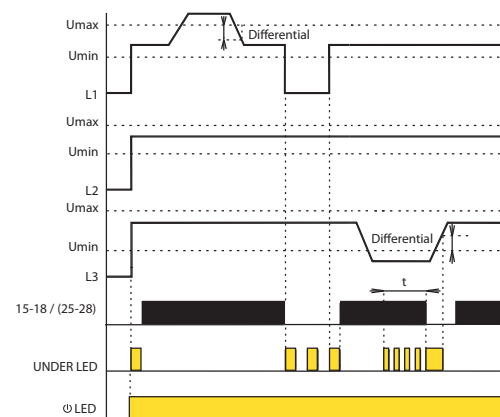

The time delay and differential trip levels help to prevent relay chatter as the monitored voltage level varies.

As the relays have changeover contacts, the relay outputs can be inverted by wiring to the alternative terminals 15-16 or 25-26.

The unit obtains its power from the separate auxiliary supply.

The green LED lights to shows when this supply is present.

Under normal conditions, with all three voltages at nominal level, the red LED will be off, the Under relay will be energised. With mains supply off the relay will be de-energised.

#### Under-voltage Operation

If the monitored voltage of any phase goes below the set under-voltage level (Umin), the Under LED will light and the Under relay (15-16/18) & (25-26/28) will de-energise after the set delay. During the delay period, the Under LED will flash.

If the voltage then returns above Umin plus the differential value, the Under LED will go off and the Under relay will energise again, without delay.



EAN code  
VRO3N-28/120: 8595188155335  
VRO3N-28/240: 8595188155342  
VRO3N-28/480: 8595188155359

Technical parameters	VRO3N-28/120	VRO3N-28/240	VRO3N-28/480
Nominal voltage range (Un):	57.7-69.3 V	100-139 V	220-277 V
	L-N		
Overload capacity			
- continuous:	87 V	174 V	346 V
- 10 s max:	104 V	209 V	416 V
Operating frequency:	45-65 Hz		
Auxiliary Supply Voltage:	24 V - 240 V AC/DC		
AC Supply frequency:	45-65 Hz		
Supply voltage tolerance:	±10%		
Auxiliary Voltage Burden (Max):	3 VA / 1.2 W		
Over-voltage range (Umax):	100-125 %Un		
Differential:	Adjustable 1-15 %Un		
Trip time delay:	Adjustable 0.5 to 10s		
Relay contacts:	2 x changeover, volt-free, for general switching operations		
Load capacity - AC:	250 V @ 8 A, 2 kVA		
Load capacity - DC:	30 V 8A		
Insulation:	4 kV/1 min		
Mechanical endurance:	30 x 10 <sup>6</sup> operations		
<b>Other Data</b>			
Dimensions:	90 x 52 x 64 mm		
Weight:	138 g		
Maximum conductor size:	2 x 1.5 mm <sup>2</sup> or 1 x 2.5 mm <sup>2</sup>		
Operating temperature:	-20 to +55 °C		
Storage temperature:	-30 to +70 °C		
Over-voltage category:	III		
Pollution degree:	2		
Environmental protection:	IP40 for front panel, IP20 for terminals		
Standards:	EN 60255-6, EN 60255-27, EN 61000-6-2, EN 61000-6-4		

#### Connection

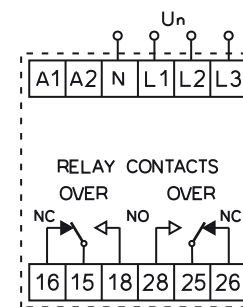

- These units monitor a 3-phase 4-wire supply and operate relays if a phase-neutral voltage goes below set levels. Front panel controls allow selection of:
  - Over voltage trip levels,
  - nominal rated voltage,
  - differential voltage for operating hysteresis and
  - time delay before a trip triggers a relay response.
- LEDs indicate power on and trip status. A relay with two changeover volt-free contacts is fitted.
- These instructions contain important safety information. Please read them thoroughly before commissioning, operation or maintenance of the unit.

#### Device description

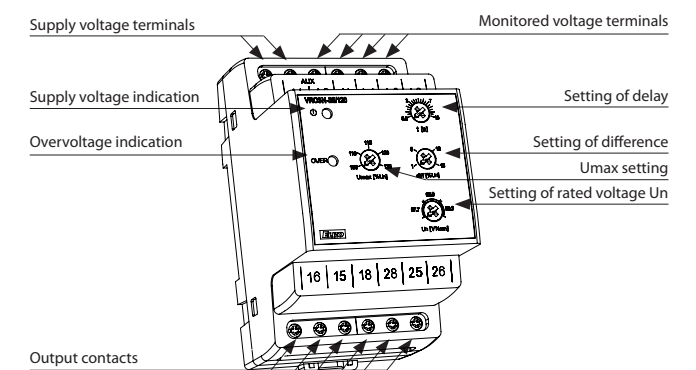

#### Function

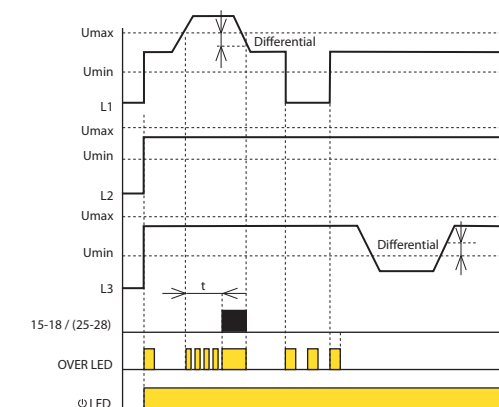

The time delay and differential trip levels help to prevent relay chatter as the monitored voltage level varies.

As the relays have changeover contacts, the relay outputs can be inverted by wiring to the alternative terminals 15-16 or 25-26.

The unit obtains its power from the separate auxiliary supply.

The green LED lights to shows when this supply is present.

Over normal conditions, with all three voltages at nominal level, the red LED will be off, the Over relay will be de-energised. With mains supply off the relay will be de-energised.

#### Over-voltage Mode

If the monitored voltage of any phase goes above the set over-voltage level (Umax), the Over LED will light and the Over relay (15-16/18) & (25-26/28) will energise after the set delay. During the delay period, the Over LED will flash.

If the voltage then falls below Umax minus the differential value, the Over relay will de-energise and the Over LED will go off, without delay.





EAN code
VRSF3-18/120: 8595188142472
VRSF3N-18/120: 8595188142502
VRSF3-18/240: 8595188142489
VRSF3N-18/240: 8595188142519
VRSF3-28/480: 8595188142496
VRSF3N-28/480: 8595188142526

Table with 4 columns: Technical parameters, 120, 240, 480. Rows include Voltage range, Overload, Supply threshold, Operating frequency, Burden on supply, Trip reset delay, Differential, Relay contacts, Load capacity, Insulation, and Mechanical endurance.

Table with 3 columns: Other Data, 90 x 17.6 x 64 mm, 90 x 52 x 64 mm. Rows include Dimensions, Weight, Maximum conductor size, Operating temperature, Storage temperature, Over-voltage category, Pollution degree, Environmental protection, and Standards.

- This unit monitors the voltage levels and phase sequence of a three-phase supply and operates a relay if any phase voltage goes below a set level or if the phase sequence (L1, L2, L3) is incorrect.
Versions are available to suit 3-wire, 3ph (VRSF3) and 4-wire, 3ph+N (VRSF3N) supplies of 110V, 220V and 430V nominal.
These instructions contain important safety information. Please read them thoroughly before commissioning, operating or maintenance of the unit.

Device description

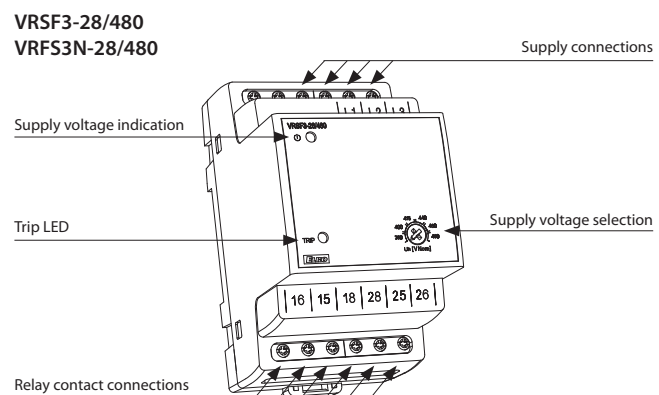
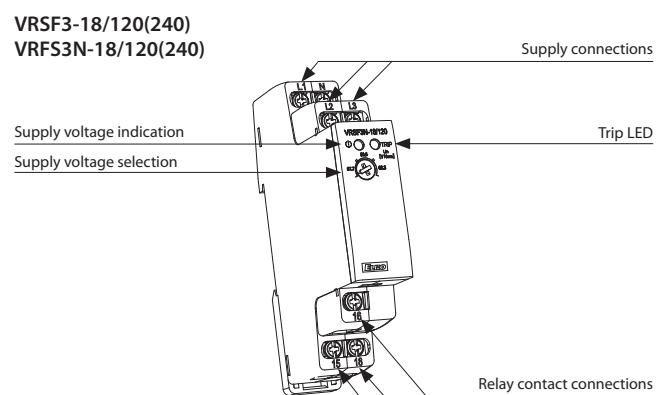

Connection

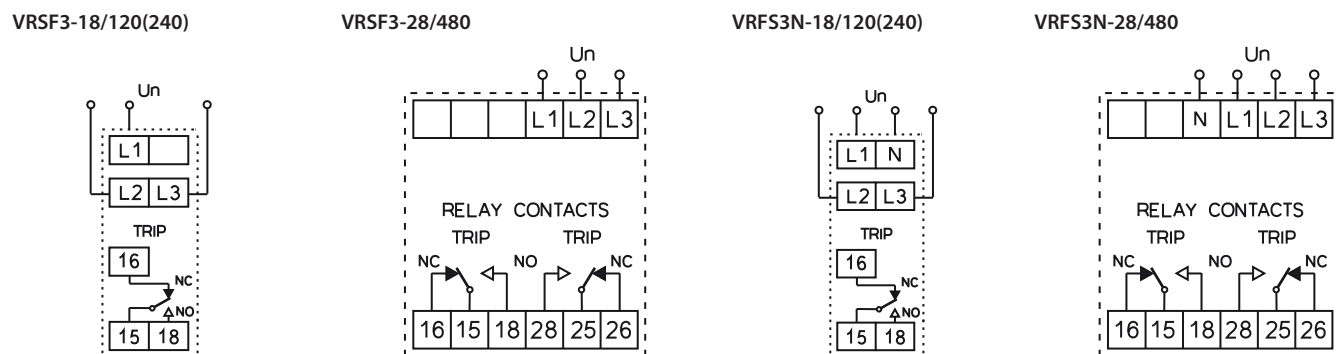

Function

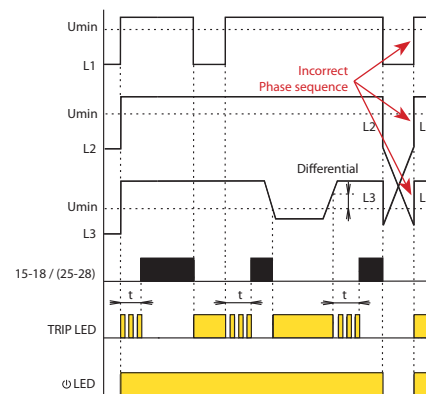

The time delay and differential trip levels help to prevent relay chatter as the monitored parameter fluctuates.

As the relay has changeover contacts, the relay outputs can be inverted by wiring to the alternative terminals 15-16 or 25-26.

The unit obtains its power supply from the supply being monitored. The green LED lights to show when this supply is present on at least one phase.

Under normal conditions, with the supply voltage at above minimum (threshold Umin) value and the phase sequencing correct (L1, L2, L3), the red LED will be off and the relay will be energised.

If the supply voltage falls below the minimum value Umin, the relay de-energises and the red Trip LED lights.

Similarly, if the supply phases are connected in the wrong sequence, e.g. L1, L3, L2, the relay de-energises and the red Trip LED lights.

Following a trip, the reset does not occur until the voltage exceeds Umin plus a differential. Then there is a delay before the relay energises again. The red Trip LED flashes during the delay period.



EAN code  
 VRBU3-18/120: 8595188142533 VRBU3N-18/120: 8595188142564  
 VRBU3-18/240: 8595188142540 VRBU3N-18/240: 8595188142571  
 VRBU3-28/480: 8595188142557 VRBU3N-28/480: 8595188142588

Technical parameters	120	240	480
Voltage range Un (Vnom):			
VRBU3 L-L	100-120 V	173-240 V	380-480 V
VRBU3N L-N	58-69 V	100-139 V	220-277 V
Overload			
- contin.: VRBU3	150 V	300 V	600 V
VRBU3N	87 V	174 V	346 V
- 10s max: VRBU3	180 V	360 V	720 V
VRBU3N	104 V	209 V	416 V
Max. operating voltage Uoff:	187 V	374 V	749 V
Burden on supply (Max):	1.7 3 VA max		
Operating frequency:	45-65 Hz		
Phase imbalance trip level:	Adjustable 5-15% Un (Vnom)		
Differential:	Fixed at 1% Un (Vnom)		
Low-voltage trip level (Umin):	Adjustable 50-85% Un (Vnom)		
Trip delay t:	Adjustable 0.5 - 10s		
Trip reset delay t <sub>r</sub> :	Fixed at 0.5s		
Relay contacts: volt-free, for general switching operations:	1 x c/o	2 x c/o	
Load capacity - AC:	250 V @ 8 A, 2 kVA		
Load capacity - DC:	30 V 8A		
Insulation:	4 kV/1 min		
Mechanical endurance:	30 x 10 <sup>6</sup> operations		
<b>Other Data</b>			
Dimensions:	90 x 17.6 x 64 mm	90 x 52 x 64 mm	
Weight:	66 g	123 g	
Maximum conductor size:	2 x 2.5 mm <sup>2</sup> or 1 x 4 mm <sup>2</sup>	2 x 1.5 mm <sup>2</sup> or 1 x 2.5 mm <sup>2</sup>	
Operating temperature:	-20 to +55 °C		
Storage temperature:	-30 to +70 °C		
Over-voltage category:	III		
Pollution degree:	2		
Environmental protection:	IP40 for front panel, IP10 for terminals	IP40 for front panel, IP20 for terminals	
Standards:	EN 60255-6, EN 60255-27, EN 61000-6-2, EN 61000-6-4		

Connection

VRBU3-18/120(240)

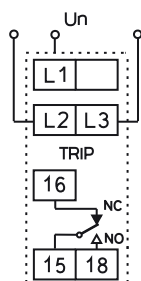

VRBU3-28/480

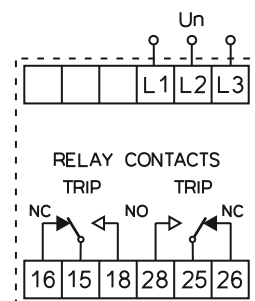

VRBU3N-18/120(240)

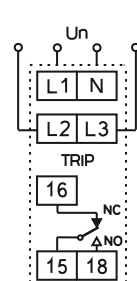

VRBU3N-28/480

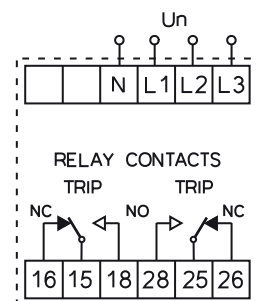

Device description

VRBU3-18/120(240)  
 VRBU3N-18/120(240)

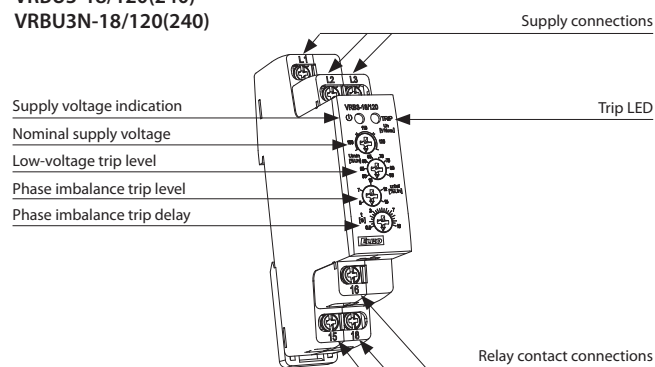

VRBU3-28/480  
 VRBU3N-28/480

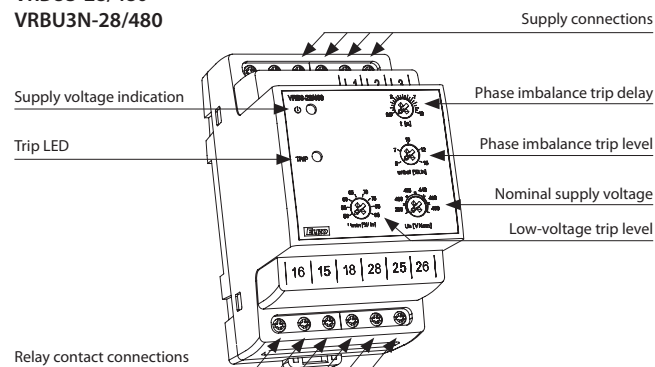

Function

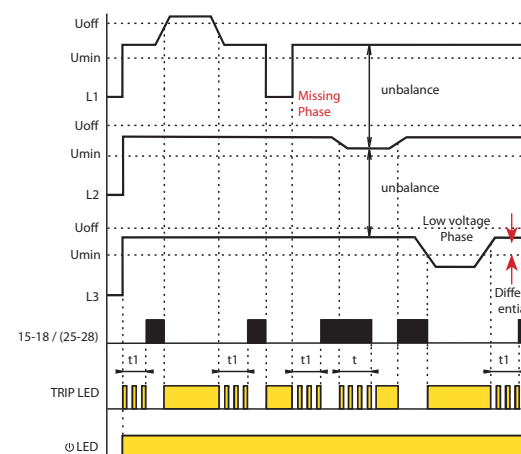

The time delay and differential trip levels help to prevent relay chatter as the monitored parameter fluctuates.

As the relay has changeover contacts, the relay outputs can be inverted by wiring to the alternative terminals 15-16 or 25-26.

The unit obtains its power supply from the supply being monitored. The green LED lights to show when this supply is present on at least one phase.

Under normal conditions, with all phases present at nominal levels (above Umin), balanced and connected in the correct sequence (L1, L2, L3), the red LED will be off and the relay will be energised.

When a trip occurs, the red LED lights and the relay De-energises. A trip will occur if:

- a supply phase falls below a set minimum value Umin or goes above a maximum limit Uoff.
- a phase is lost,
- one phase voltage differs from the others by more than the percentage set by the imbalance trip level control. This trip will be delayed by the time t set by the front panel control, OR
- If the supply phases are connected in the wrong sequence, e.g. L1, L3, L2.

After the cause of a trip has been removed, there will be a short, fixed delay t1 before a reset occurs, the relay energises again and the red LED goes off. Following a low voltage trip, the reset does not occur until the voltage exceeds Umin plus a differential. The red Trip LED flashes during any delay period.



EAN code  
CROU1-28/1: 8595188142090  
CROU1-28/5: 8595188142106

Technical parameters	CROU1-28/1	CROU1-28/5
<b>Monitored supply</b>		
Load current rating In:	1 A	5 A
Maximum overload - permanent:	2 A	10 A
Maximum overload - for 3s max:	20 A	50 A
Voltage rating:	500V max.	
Operating frequency:	45-65 Hz	
Current trip level - adjustable:	40-120% of In	
Trip time delay - adjustable:	0.5 to 10s	
Hysteresis differential:	Preset to 1% of range	
Auxiliary supply:	24-240V AC or DC $\pm 10\%$ 1.2W/3VA	
AC frequency range	45-65 Hz	
Relay contacts:	2 x changeover, volt-free, for general switching operations	
Load capacity - AC:	250 V @ 8 A, 2 kVA	
Load capacity - DC:	30 V 8A	
Insulation:	4 kV/1 min	
Mechanical endurance:	30 x 10 <sup>6</sup> operations	
<b>Other Data</b>		
Dimensions:	90 x 52 x 64 mm	
Weight:	129 g	
Maximum conductor size:	2 x 1.5 mm <sup>2</sup> or 1 x 2.5 mm <sup>2</sup>	
Operating temperature:	-20 to +55 °C	
Storage temperature:	-30 to +70 °C	
Over-voltage category:	III	
Pollution degree:	2	
Environmental protection:	IP40 for front panel, IP20 for terminals	
Standards:	EN 60255-6, EN 60255-27, EN 61000-6-2, EN 61000-6-4	

**Connection**

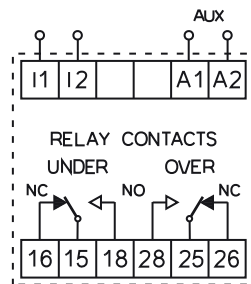

- These units monitor the AC current to a load and operate relays if the current goes below or above a set level. Front panel controls allow selection of:
  - Under and Over-current operation,
  - current trip level and
  - time delay before a trip triggers a relay response.
- LEDs indicate power on and trip status. A relay with two changeover volt-free contacts is fitted.
- Two versions for each type are available for monitoring currents of up to 1A (CROU1-28/1) and 5A (CROU1-28/5).
- The unit can be powered either by a separate auxiliary supply of 24-240V AC or DC or by the monitored supply, if suitable.
- These instructions contain important safety information. Please read them thoroughly before commissioning, operation or maintenance of the unit.

**Device description**

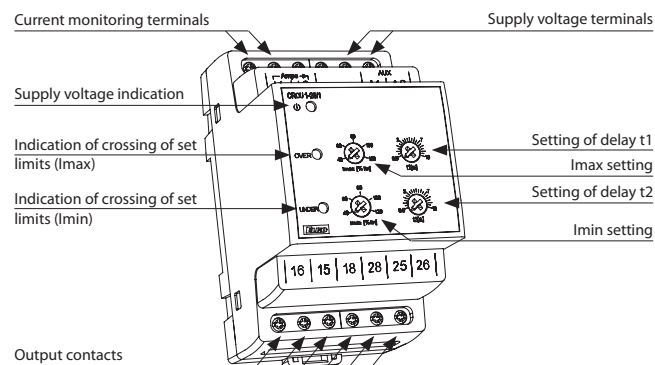

**Function**

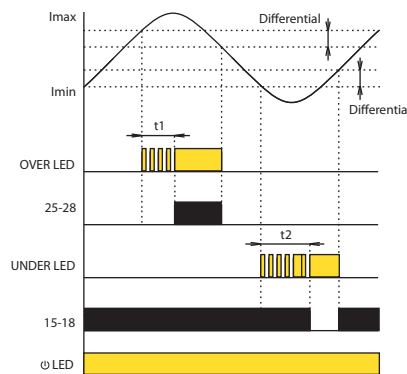

The time delay and differential trip levels help to prevent relay chatter as the monitored current level varies. As the relays have changeover contacts, the relay outputs can be inverted by wiring to the alternative terminals 15-16 or 25-26.

**Under-current Mode**

While the monitored current is greater than the set level Imin, the Under relay is energised (NO contacts 15-16 are closed) and the red Under LED is off.

If the current goes below the set level Imin, after the set time delay, the Under relay de-energises, contacts 15-18 open and the red Under LED lights. During the delay period, the LED flashes.

When the current returns above the set level Imin plus the under-current differential of 1%, the relay changes back without delay and the Under LED goes off.

**Over-current Mode**

While the monitored current is less than the set level Imax, the Over relay is de-energised (NO contacts 25-26 are open) and the Over red LED is off.

If the current goes above the set level Imax, after the set time delay, the Over relay energises, contacts change over (contacts 25-28 close) and the red Over LED lights. During the delay period, the Over LED flashes.

When the current returns below the set level Imax minus the over-current differential of 1%, the relay changes back without delay and the Over LED goes off.



EAN code  
CRU1-18/1: 8595188142076  
CRU1-18/5: 8595188142083  
CRO1-18/1: 8595188142113  
CRO1-18/5: 8595188142120

Technical parameters	CRU1-18/1	CRO1-18/1	CRU1-18/5	CRO1-18/5
<b>Monitored supply</b>				
Load current rating In:	1 A		5 A	
Max. overload - permanent:	2 A		10 A	
Max. overload - for 3s max:	20 A		50 A	
Voltage rating:	500V max.			
Operating frequency:	45-65 Hz			
Current trip level - adjustable (In):	40-120% of In			
Trip time delay - adjustable:	0.5 to 10s			
Hysteresis differential:	Preset to 1% of range			
Auxiliary supply:	24-240V AC or DC $\pm 10\%$ 1.2W/3VA			
AC frequency range:	45-65 Hz			
Relay contacts:	1 x changeover, volt-free, for general switching operations			
Load capacity - AC:	250V @ 8A, 2 kVA			
Load capacity - DC:	30V 8A			
Insulation:	4 kV/1 min			
Mechanical endurance:	30 x 10 <sup>6</sup> operations			
<b>Other Data</b>				
Dimensions:	90 x 17.6 x 64 mm			
Weight:	70 g			
Maximum conductor size:	2 x 2.5 mm <sup>2</sup> or 1 x 4 mm <sup>2</sup>			
Operating temperature:	-20 to +55 °C			
Storage temperature:	-30 to +70 °C			
Overvoltage category:	III			
Pollution degree:	2			
Environmental protection:	IP40 for front panel, IP10 for terminals			
Standards:	EN 60255-6, EN 60255-27, EN 61000-6-2, EN 61000-6-4			

**Connection**

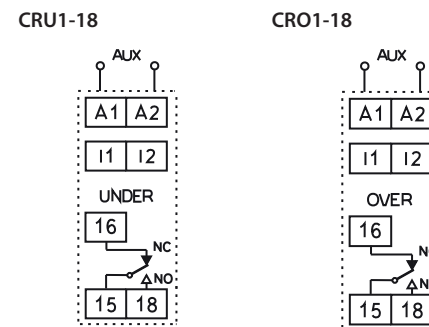

- These units monitor the AC current to a load and operate relays if the current goes below or above a set level. Front panel controls allow selection of:
  - Under (CRU1-18) - or Over (CRO1-18)-current operation,
  - current trip level and
  - time delay before a trip triggers a relay response.
- LEDs indicate power on and trip status. A relay with volt-free changeover contacts is fitted.
- Two versions for each type are available for monitoring currents of up to 1A (CRU1-18-1, CRO1-18/1) and 5A (CRU1-18/5, CRO1-18/5)
- The unit can be powered either by a separate auxiliary supply of 24-240V AC or DC or by the monitored supply, if suitable.
- These instructions contain important safety information. Please read them thoroughly before commissioning, operation or maintenance of the unit.

**Description**

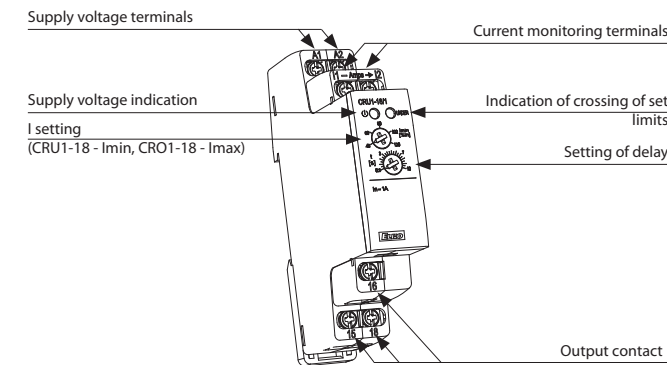

**Function**

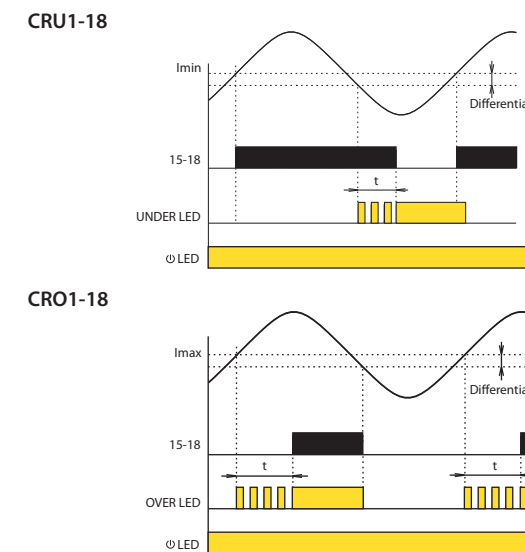

The time delay and differential trip levels help to prevent relay chatter as the monitored current level varies. As the relays have changeover contacts, the relay outputs can be inverted by wiring to the alternative terminals 15-16 or 25-26.

**Under-current Mode (Model CRU1-18)**

While the monitored current is greater than the set level Imin, the relay is energised (NC contacts 15-16 are open) and the red LED is off.

If the current goes below the set level Imin, after the set time delay, the relay de-energises, contacts 15-16 close and the red LED lights. During the delay period, the LED flashes.

When the current returns above the set level Imin plus the under-current differential of 1%, the relay changes back without delay and the LED goes off.

**Over-current Mode (Model CRO1-18)**

While the monitored current is less than the set level Imax, the relay is de-energised (NO contacts 15-18 are open) and the red LED is off.

If the current goes above the set level Imax, after the set time delay, the relay energise, contacts change over (contacts 15-18 close) and the red LED lights. During the delay period, the LED flashes.

When the current returns below the set level Imax minus the over-current differential of 1%, the relay changes back without delay and the LED goes off.





EAN code  
CRGF1-28/24: 8595188142755  
CRGF1-28/240: 8595188142762

Technical parameters	CRGF1-18/240	CRGF1-18/24
Supply terminals:	A1, A2	
Monitoring terminals (for current shunt):	N, G	
External current shunt:	0.2 mΩ or 2 mΩ	
Supply voltage:	24-240VAC/DC(45-65Hz) 12 - 24V DC	
Adjustable current level:	100A, 150A, 200A, 250A, 300A, 450A, 600A, 750A, 800A, 1200A,	
Overload capacity:	max. input voltage 600V (in case of shunt failure)	
Indication of exceeding the monitored current:	60% I <sub>max</sub> - red LED TRIP 60% 100% I <sub>max</sub> - red LED TRIP 100%	
Adjustable delay:	0 s/ 0.1s/ 0.2s/ 0.4s/ 0.6s/ 0.8s/ 1s/ 2s/ 5s/ 10s*	
Response time:	max. 40ms	
Analogue output:	0 - 1mA = 0...100% set current values	
Output relay - contact:	2x switchable (AgNi) gilded	
AC contact capacity:	250V / 8 A, max. 2000VA	
DC contact capacity:	30V / 8A	
Mechanical service life:	3x10 <sup>6</sup> at rated load	
<b>Other data</b>		
Working temperature:	-20.. +55 °C	
Storage temperature:	-30.. +70 °C	
Dielectric strength (power supply - contact relay):	4 kV / 1min	
Excess voltage category:	III.	
Contamination degree:	2	
Protection:	IP 40 from the front panel / IP20 terminals	
Connecting conductor cross section:	max. 2 x 1.5mm <sup>2</sup> / 1 x 2.5mm <sup>2</sup>	
Dimension:	90 x 52 x 64 mm	
Weight:	128 g	125 g

\* If the set current value is exceeded 5 times the time delay is ignored.

- monitors the dangerous value of the leakage ground current that can cause e.g. undesirable overheating of cables and a subsequent failure of the device or even dangerous voltage of the grounded device
- serves as protection of electrical engines, generators, transformers and other devices
- continuous monitoring of the current value using an external current shunt
- very short response time (< 40ms)
- step-adjustable value of monitored current (in 10 steps)
- step-adjustable response delay (in 10 steps)
- indication of exceeding 2 levels of monitored current (60 and 100% I<sub>max</sub>)
- selection of the value of a shunt on the device panel - 0.2 mΩ or 2 mΩ
- switching the relay mode on the device panel - LATCH ON or OFF
- RESET & TEST button for the return to the initial state or device test
- analogue output 0...1mA for the control meter
- 2 types according to the value of the supply voltage: 24 - 240V AC/DC or 12 - 24V DC
- 3-module version, mounted onto the DIN rail

#### Device description

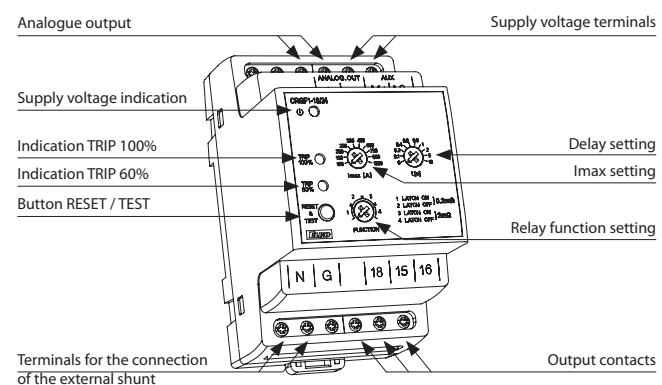

#### Connection

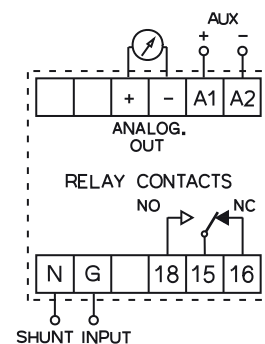

N - neutral (neutral conductor)  
G - ground (grounding conductor)

#### Function

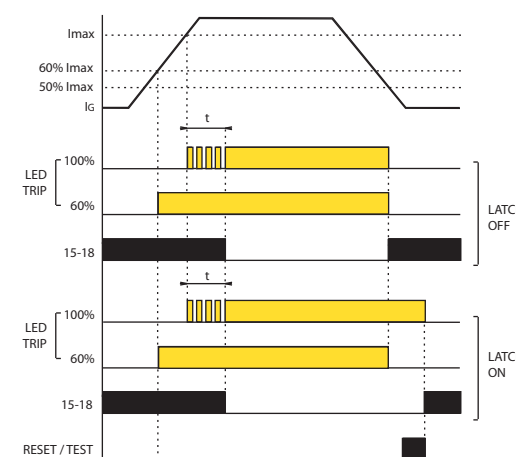

#### Function description

After the connection of the supply voltage to the supply terminals (A1-A2) the green LED goes on and the output relay is activated. The device is monitoring the value of the ground current (AC voltage from the shunt at terminals N, G) by means of the external current shunt. If the current value exceeds 60% of the set value I<sub>max</sub> the red LED TRIP 60% goes on. When the set value of the I<sub>max</sub> current (100%) is exceeded after the elapse of the delay timing the relay is disconnected and the red LED TRIP goes on. The red LED flashes during the timing.

If the set current value is exceeded 5 times the relay is disconnected without delay.

#### LATCH ON function description

If the current value drops below the set value of 50% I<sub>max</sub> both the relay and the red LED TRIP 100% remain unchanged. LED TRIP 60% goes off.

The relay returns into the idle state (is activated) by briefly pressing the RESET & TEST button and the LED TRIP 100% goes off. It can also be reset by short-circuiting the input terminals (N, G).

#### LATCH OFF function description

If the current value drops below the set value of 50% I<sub>max</sub> the relay and both the red LEDs return into the idle state (are activated).

By pressing and holding (for longer than 1s) the button the device test is activated - both the relays and the red LED respond in the same way as in the case of exceeding the set current value. After releasing the button the relay returns to the initial state.



EAN code  
CRMA1-28/24: 8595188145701  
CRMA1-28/240: 8595188145718

Technical parameters	CRMA1-28/24	CRMA1-28/240
Supply voltage:	12-24V DC	24V-240V AC/DC
Burden on supply:	1W	3VA/0.9W
AC Supply frequency:		45-65 Hz
Supply voltage tolerance:		±10%
Monitored DC current (I <sub>lin</sub> ):	0-1, 0-10 and 4-20 mA	
Voltage drop across input:	1V max. at 120% I <sub>lin</sub>	
Over-current range (I <sub>max</sub> ):	40-120 % I <sub>lin</sub>	
Under-current range (I <sub>min</sub> ):	0-80 % I <sub>lin</sub>	
Overload capacity		
- continuous:	3 x I <sub>lin</sub>	
- 1s max.:	10 x I <sub>lin</sub>	
Differential:	Fixed at 1% I <sub>lin</sub>	
Trip time delay:	Adjustable 0.5 to 10s	
Relay contacts:	2 x changeover, volt-free, for general switching operations	
Load capacity - AC:	250 V @ 8 A, 2 kVA	
Load capacity - DC:	30 V 8A	
Insulation:	4 kV/1 min	
Mechanical endurance:	30 x 10 <sup>6</sup> operations	

#### Other Data

Dimensions:	90 x 52 x 64 mm
Weight:	135 g approx.
Maximum conductor size:	2 x 1.5 mm <sup>2</sup> or 1 x 2.5 mm <sup>2</sup>
Operating temperature:	-20 to +55 °C
Storage temperature:	-30 to +70 °C
Over-voltage category:	III
Pollution degree:	2
Environmental protection:	IP40 for front panel, IP20 for terminals
Standards:	EN 60255-6, EN 60255-27, EN 61000-6-2, EN 61000-6-4

- These units monitor a current of 0-1, 0-10 or 4-20 mA, e.g. from a transducer, and operates one of two relays if the current goes above or below set levels. Front panel controls allow selection of:
  - under- and over-current trip levels I<sub>max</sub>, I<sub>min</sub>
  - nominal rated current of 0-1, 0-10 or 4-20 mA (I<sub>lin</sub>)
  - time delay before a trip triggers a relay response.
- LEDs indicate power on and trip status. Two changeover, volt-free relays are fitted.
- Two types are available - a 12-24 unit powered from 12-24V DC and a 24-240 unit powered from 24V-240V AC or DC
- These instructions contain important safety information. Please read them thoroughly before commissioning, operating or maintenance of the unit.

#### Device description

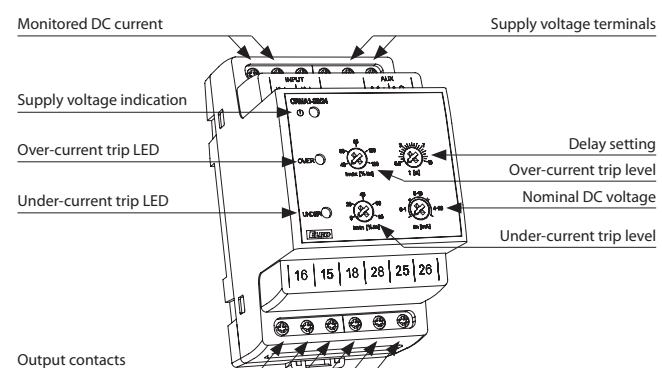

#### Connection

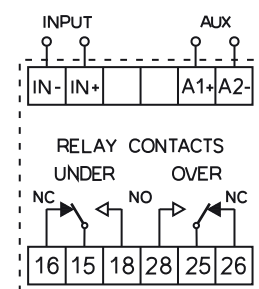

#### Function

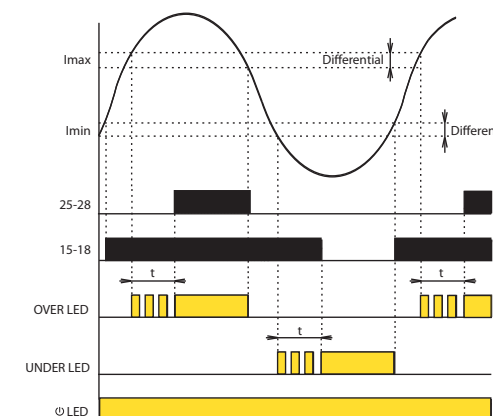

The time delay and differential trip levels help to prevent relay chatter as the monitored voltage level varies.

As the relays have changeover contacts, the relay outputs can be inverted by wiring to the alternative terminals 15-16 or 25-26.

The green LED lights to show when the supply is present.

Under normal conditions, with the monitored current at nominal levels, both red LEDs will be off, the Under relay will be energised and the Over relay will be de-energised. With supply voltage off, both relays will be de-energised.

#### Under-current Operation

If the monitored current goes below the set under-current level (I<sub>min</sub>), the Under LED will light and the Under relay (15-16/18) will de-energise after the set delay. During the delay period, the Under LED will flash.

If the current then returns above I<sub>min</sub> plus the differential value, the Under LED will go off and the Under relay will energise again, without delay.

#### Over-current Operation

If the monitored current goes above the set over-current level (I<sub>max</sub>), the Over LED will light and the Over relay (25-26/28) will energise after the set delay. During the delay period, the Over LED will flash.

If the current then falls below I<sub>max</sub> minus the differential value, the Over relay will de-energise and the Over LED will go off, without delay.



EAN code  
 CRRP1-28/120: 8595188145725 CRRP3-28/120: 8595188142670  
 CRRP1-28/240: 8595188142656 CRRP3-28/240: 8595188142687  
 CRRP1-28/480: 8595188142663 CRRP3-28/480: 8595188142694

Technical parameters	120	240	480
Voltage range (Vnom):			
CRRP1-28 ph-N	57.7-69.3	100-139	220-277
CRRP3-28 ph-ph	100-120	173-240	380-480
Overload			
- cont.: CRRP1-28	87 V	174 V	346 V
CRRP3-28	150 V	300 V	600 V
- 10s max: CRRP1-28	104 V	209 V	416 V
CRRP3-28	180 V	360 V	720 V
Max. power input (VA/W):			
CRRP1-28	1.4/1	1.6/1.3	2.9/2.1
CRRP3-28	2.5/1.5	4.2/3.2	6/4
Min supply voltage (Uopen):			
CRRP1-28	35 V	60 V	132 V
CRRP3-28	3x 60 V	3x 104 V	3x 228 V
Weight:			
CRRP1-28	199 g	199 g	203 g
CRRP3-28	201 g	204 g	211 g
Nominal currents lin:	2A, 3A, 4A, 5A, 8A, 10A		
Operating frequency:	45-65 Hz		
Monitored current range:	2..100% lin		
Monitored cos $\Phi$ range:	0.2 inductive to 0.2 capacitive		
Reverse power setpoint range:	2..20% (cos $\Phi$ = 1)		
Differential:	fixed at 1%		
Trip delay t:	Adjustable 0.5 - 20s		
Relay contacts:	2 x changeover, volt-free, for general switching operations		
Load capacity - AC:	250 V @ 8 A, 2 kVA		
Load capacity - DC:	30 V 8A		
Insulation:	4 kV/1 min		
Mechanical endurance:	30 x 10 <sup>6</sup> operations at rated load		
<b>Other Data</b>			
Dimensions:	90 x 105 x 64 mm		
Maximum conductor size:	2 x 1.5 mm <sup>2</sup> or 1 x 2.5 mm <sup>2</sup>		
Operating temperature:	-20 to +55 °C		
Storage temperature:	-30 to +70 °C		
Over-voltage category:	III		
Pollution degree:	2		
Environmental protection:	IP40 for front panel, IP20 for terminals		
Standards:	EN 60255-6, EN 60255-27, EN 61000-6-2, EN 61000-6-4		

- This unit monitors a single- or three-phase supply for reverse power and trips a relay if it detects reverse power ( $I \times \cos \Phi$ ) over a set limit. The relay output is typically used to prevent 'motoring' of a generator (where the generator turns the engine), which can damage the engine.
- Front panel controls allow selection of trip level, nominal operating current and trip delay. LEDs indicate power on and trip status.
- Versions are available to suit 3-phase 3-wire L-L (CRRP3-28) and 3-phase 4-wire L-N (CRRP1-28) systems.
- These instructions contain important safety information. Please read them thoroughly before commissioning, operating or maintenance of the unit.

#### Device description

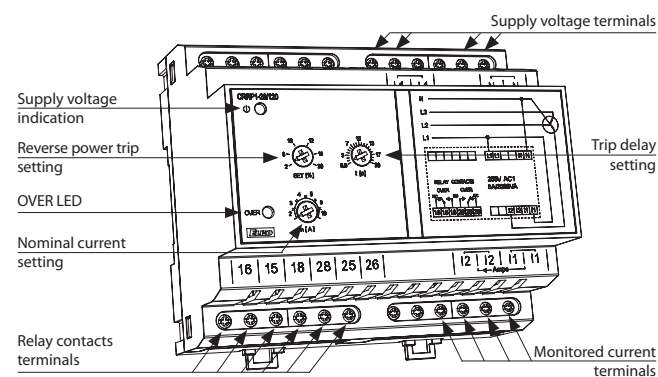

#### Connection

##### CRRP1-28

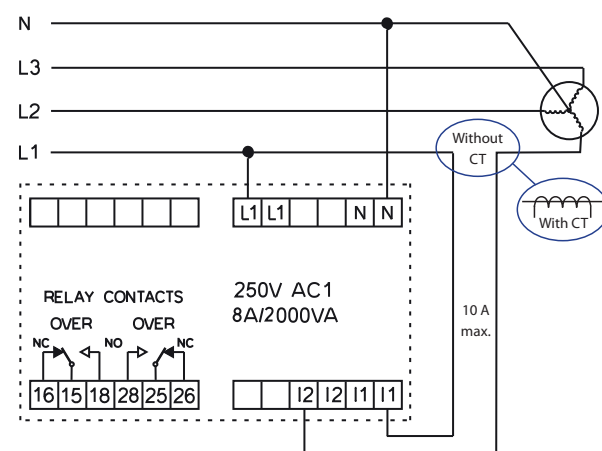

##### CRRP3-28

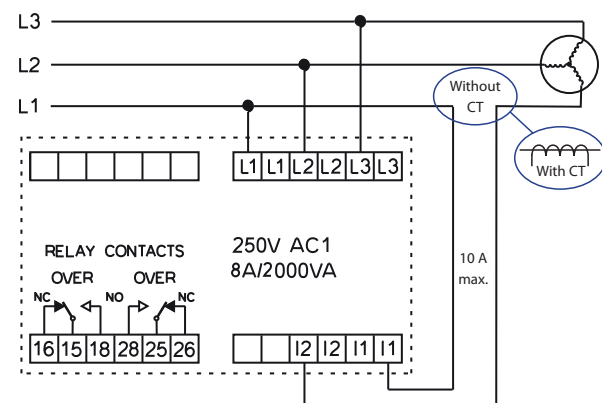

#### Function

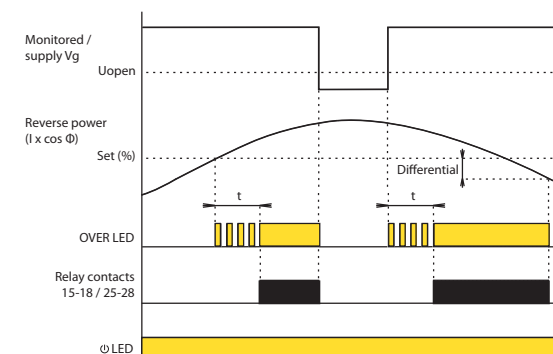

The time delay and differential trip levels help to prevent relay chatter as the monitored parameters fluctuate.

As the relay has changeover contacts, the relay outputs can be inverted by wiring to the alternative terminals 15-16 or 25-26.

The unit obtains its power supply from the supply being monitored. The green LED lights to show when this supply is present on at least one phase.

Under normal forward current conditions, the red LED will be off and the relay will be de-energised.

If the reverse power ( $I \times \cos \Phi$ ) exceeds the set level, the relay energises and the red OVER LED lights after the time delay set by the trip delay control. The red LED flashes during the delay period.

When the reverse power falls below the set level plus the 1% differential, the relay de-energises and the red OVER LED goes off.

If the monitored supply voltage falls below the minimum level  $U_{open}$ , the relay de-energises and the red OVER LED goes off.





EAN code  
CROU3N-28/1: 8595188142137  
CROU3N-28/5: 8595188142144

Technical parameters	CROU3N-28/1	CROU3N-28/5
<b>Monitored supply</b>		
Load current rating In:	1 A	5 A
Max. overload - permanent:	2 A	10 A
Max. overload - for 3s max:	20 A	50 A
Voltage rating:	500V max.	
Operating frequency:	45-65 Hz	
Current trip level – adjustable (In):	40-120% of In	
Trip time delay – adjustable:	0.5 to 10s	
Hysteresis differential	Preset to 1% of range	
Auxiliary supply:	24-240V AC or DC $\pm 10\%$ 1.2W/3VA	
AC frequency range:	45-65 Hz	
Relay contacts:	2 x changeover, volt-free, for general switching operations	
Load capacity - AC:	250V @ 8A, 2 kVA	
Load capacity - DC:	30V 8A	
Insulation:	4 kV/1 min	
Mechanical endurance:	30 x 10 <sup>6</sup> operations	
<b>Other Data</b>		
Dimensions:	90 x 105 x 64 mm	
Weight:	208 g	
Maximum conductor size:	2 x 1.5 mm <sup>2</sup> or 1 x 2.5 mm <sup>2</sup>	
Operating temperature:	-20 to +55 °C	
Storage temperature:	-30 to +70 °C	
Overvoltage category:	III	
Pollution degree:	2	
Environmental protection:	IP40 for front panel, IP20 for terminals	
Standards:	EN 60255-6, EN 60255-27, EN 61000-6-2, EN 61000-6-4	

#### Connection

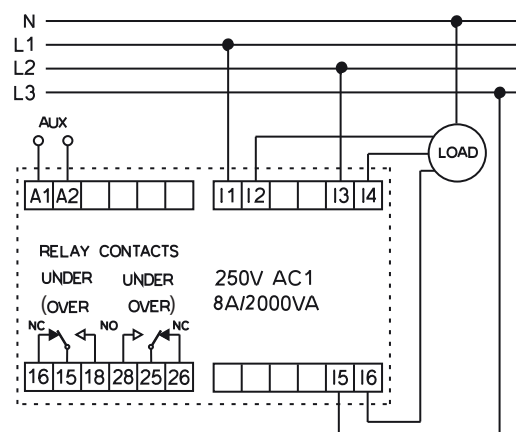

- These units monitor the AC current to a load and operate relays if the current goes below or above a set level. Front panel controls allow selection of:
  - Under- or Over-current operation,
  - current trip level and
  - time delay before a trip triggers a relay response.
- LEDs indicate power on and trip status. A relay with two changeover volt-free contacts is fitted.
- Two versions are available for monitoring currents of up to 1A (CROU3N-28/1) and 5A (CROU3N-28/5)
- The unit can be powered either by a separate auxiliary supply of 24-240V AC or DC or by the monitored supply, if suitable.
- These instructions contain important safety information. Please read them thoroughly before commissioning, operation or maintenance of the unit.

#### Description

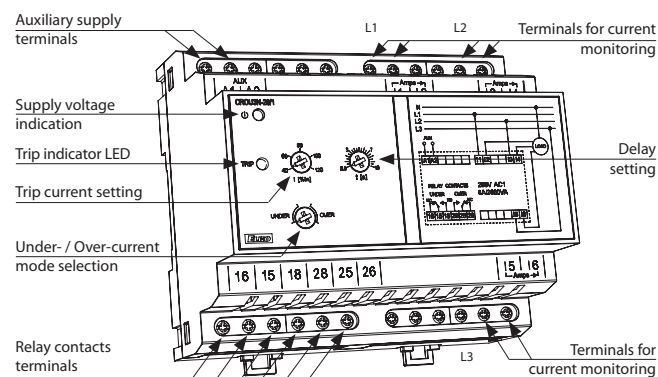

#### Function

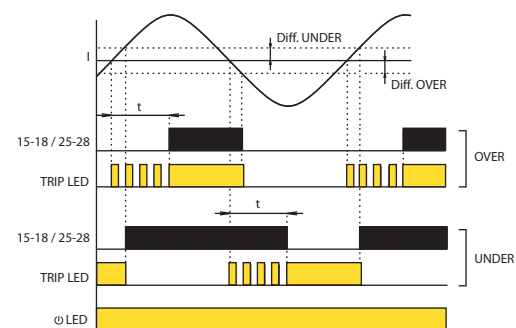

The time delay and differential trip levels help to prevent relay chatter as the monitored current level varies. As the relays have changeover contacts, the relay outputs can be inverted by wiring to the alternative terminals 15-16 or 25-26.

#### Under-current Mode

While the monitored current in all phases is greater than the set level, the relay is energised (NC contacts 15-16 and 25-26 are open) and the red LED is off. If the current in any phase goes below the set level, after the set time delay, the relay de-energises, contacts 15-16 and 25-26 close and the red LED lights. During the delay period, the LED flashes.

When the current returns above the set level plus the under-current differential, the relay changes back without delay and the LED goes off.

#### Over-current Mode

While the monitored current is less than the set level  $I$ , the relay is de-energised (NO contacts 15-18 and 25-28 open) and the red LED is off.

If the current in any phase goes above the set level, after the set time delay, the relay energises, contacts change over (contacts 15-18 and 25-28 close) and the red LED lights. During the delay period, the LED flashes.

When the current returns below the set level minus the over-current differential, the relay changes back without delay and the LED goes off.



EAN code  
FROU1-28/87: 8595188145671  
FROU1-28/174: 8595188145688  
FROU1-28/346: 8595188144827  
FROU1-28/500: 8595188150118

Technical parameters	87	174	346	500
Nominal voltage range:	43-87 V	71-174 V	161-346 V	161-500 V
<b>Overload capacity</b>				
- continuous:	87 V	174 V	346 V	500 V
- 10 s max:	104 V	209 V	416 V	550 V
Supply threshold (Uopen):	42 V	73 V	161 V	
Burden on supply (Max):	1W 1.6 VA approx.			
Nominal frequency (Fn):	50/60/400 Hz			
Over-frequency range (Fmax):	Adjustable 80-120 %Fn			
Under-frequency range (Fmin):	Adjustable 80-120 %Fn			
Differential:	Adjustable 0.5 to 5 %Fn			
Trip time delay:	Adjustable 0.5 to 10s			
Relay contacts:	2 x changeover, volt-free, for general switching operations			
Load capacity - AC:	250 V @ 8 A, 2 kVA			
Load capacity - DC:	30 V 8A			
Insulation:	4 kV/1 min			
Mechanical endurance:	30 x 10 <sup>6</sup> operations			
<b>Other Data</b>				
Dimensions:	90 x 52 x 64 mm			
Weight:	124 g approx.			
Maximum conductor size:	2 x 1.5 mm <sup>2</sup> or 1 x 2.5 mm <sup>2</sup>			
Operating temperature:	-20 to +55 °C			
Storage temperature:	-30 to +70 °C			
Over-voltage category:	III			
Pollution degree:	2			
Environmental protection:	IP40 for front panel, IP20 for terminals			
Standards:	EN 60255-6, EN 60255-27, EN 61000-6-2, EN 61000-6-4			

#### Connection

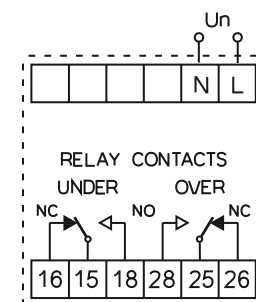

- This unit monitors the frequency of a single phase supply and operates a relay if the frequency goes above or below set levels. Front panel controls allow selection of:
  - nominal, under- and over-frequencies,
  - hysteresis (differential) and
  - time delay before a trip triggers a relay response.
- LEDs indicate power on and trip status. Two changeover, volt-free relays are fitted.
- These instructions contain important safety information. Please read them thoroughly before commissioning, operating or maintenance of the unit.

#### Device description

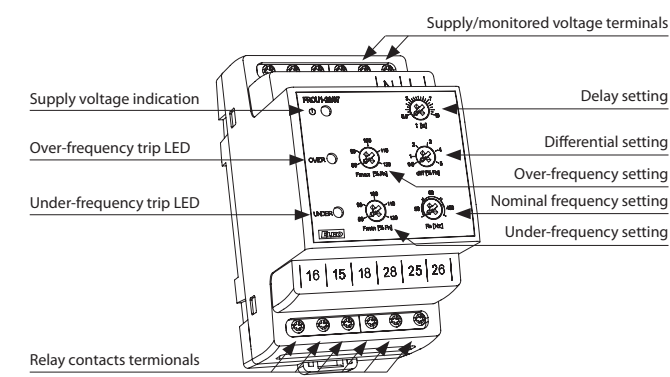

#### Function

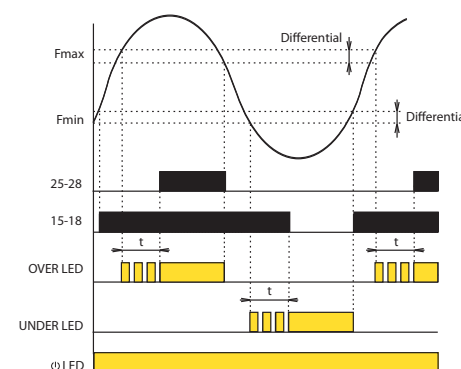

The time delay and differential trip levels help to prevent relay chatter as the monitored frequency varies.

As the relays have changeover contacts, the relay outputs can be inverted by wiring to the alternative terminals 15-16 or 25-26.

The unit obtains its power supply from the supply being monitored.

The green LED lights to show when this supply is present.

Under normal conditions, with the supply frequency at near nominal value, both red LEDs will be off, the Under relay will be energised and the Over relay will be de-energised. If the supply falls below the operating threshold Uopen, both relays de-energise and both LEDs flash slowly to indicate insufficient supply voltage.

#### Under-frequency Operation

If the supply frequency goes below the set under-frequency (Fmin), the Under LED will light and the Under relay (15-16/18) will de-energise after the set delay. During the delay period, the Under LED will flash. If the frequency then returns above Fmin plus the differential value, the Under LED will go off and the Under relay will energise again, without delay.

#### Over-frequency Operation

If the supply frequency goes above the set over-frequency (Fmax), the Over LED will light and the Over relay (25-26/28) will energise after the set delay. During the delay period, the Over LED will flash. If the frequency then falls below Fmax minus the differential value, the Over relay will de-energise and the Over LED will go off, without delay.



EAN code  
FRSS1-38/130: 8595188142700

### Technical parameters FRSS1-38/130

Supply voltage:	12-24V DC
Supply voltage tolerance:	+20/-10%
Burden on supply:	1.4W max.
Input pulse amplitude:	5-75V p-p
Frequency range:	0-1 kHz min, 0-10 kHz max
Trip settings:	w.r.t calibrated speed:
Cranking:	10-50%
Under-speed:	50-100%
Over-speed:	100-130%
Differential:	Fixed at 2%
Analogue (meter) output:	0-1 mA
at 100% rated speed:	0.75 mA
at 133% rated speed:	1 mA
Relay contacts:	3 x changeover, volt-free, for general switching operations
Load capacity - AC:	250 V @ 8 A, 2 kVA
Load capacity - DC:	30 V 8A
Insulation:	4 kV/1 min
Mechanical endurance:	30 x 10 <sup>6</sup> operations

### Other Data

Dimensions:	90 x 52 x 64 mm
Weight:	133 g
Maximum conductor size:	2 x 1.5 mm <sup>2</sup> or 1 x 2.5 mm <sup>2</sup>
Operating temperature:	-20 to +55 °C
Storage temperature:	-30 to +70 °C
Over-voltage category:	III
Pollution degree:	2
Environmental protection:	IP40 for front panel, IP20 for terminals
Standards:	EN 60255-6, EN 60255-27, EN 61000-6-2, EN 61000-6-4

### Calibration

The unit can be calibrated by supplying an appropriate input to the sensor input terminals and pressing the Adjust button for more than 3s. This input then becomes the 100% reference used by the meter.

The required sensor input can be obtained either by running the engine at the required speed or by providing a pulse input at the appropriate frequency from a pulse generator.

- This unit monitors the speed of rotating equipment using a magnetic pick-up and provides three relay outputs according to measured speeds. The pick-up could, for instance, detect teeth on a rotating gear or flywheel. The unit also provides a tachometer output for speed indication. The relay outputs can be used for alarm or control purposes. LEDs indicate power on and relay status.
- Controls on the front panel set the trip points at which the relays and LEDs operate:
  - Crank speed - set just above the speed of the crank motor.
  - Under speed - set below the normal running speed (<100%)
  - Over speed - set to the maximum permitted speed (>100%).
- The unit can be calibrated such that a standard 100% on the unit represents the required nominal engine speed.
- These instructions contain important safety information. Please read them thoroughly before commissioning, operating or maintenance of the unit.

### Device description

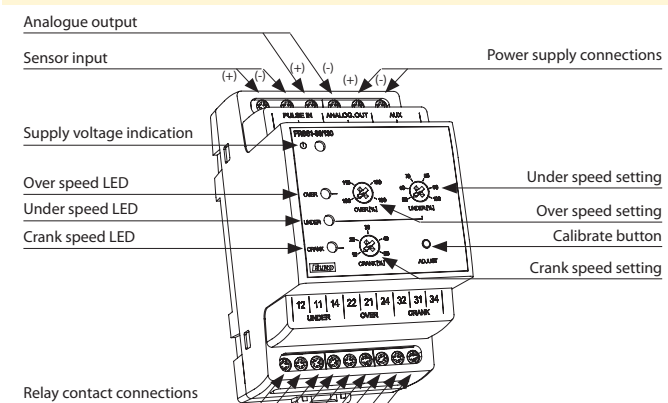

### Connection

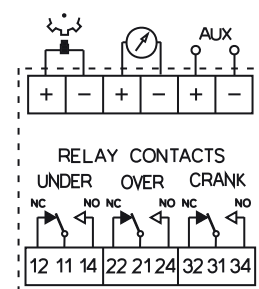

### Function

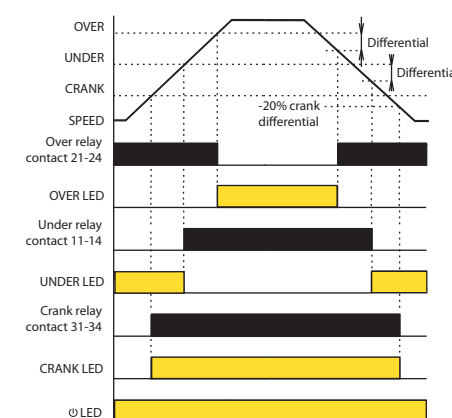

The differential trip levels help to prevent relay chatter as the monitored speed varies.

As the relays have changeover contacts, the relay outputs can be inverted by wiring to the alternative terminals 11-12, 21-22 or 31-32.

The green LED lights shows when the power supply is on.

With the motor running at its normal speed, between Under and Over speed settings, only the green and amber LEDs will be on and all three relays will be energised.

### Crank

The Crank LED lights and the crank relay energises when the engine speed exceeds the Crank setting. This is normally set just above the cranking speed of the crank motor so that the unit indicates that the engine has started.

The LED goes off and the relay de-energises when the engine speed falls 20% below the crank speed setting.

### Under-speed

The Under LED goes off and the relay energises when the engine speed exceeds Under-speed control setting.

The LED lights and the relay de-energises when the engine speed falls below the Under-speed control setting minus a 2% differential.

### Over-speed

Normally, the Over relay is energised and the LED is off. If the engine speed exceeds the Over-speed limit setting, the Over relay de-energises and the LED lights. The relay remains de-energised with the LED on until the speed drops below the limit setting minus the 2% differential.

### Sensor disconnection

If the sensor becomes disconnected, the Over LED flashes, the Over relay de-energises, the Crank and Under relays energise and the Crank and Under LEDs light.



EAN code  
TR1-18/3.3: 8595188137164

Technical parameters	TR1-18/3.3
Supply voltage:	24-240V AC (50-60Hz) or DC
Supply voltage tolerance:	-15/+10%
Burden on supply:	2 VA max
PTC sensor ranges	
Cold:	50Ω - 1.5 kΩ
Lower limit:	1.8 kΩ
Upper limit:	3.3 kΩ
Sensor failure indication:	Red LED flashes
Repetition accuracy (mech):	<5%
Switching error:	±5%
Temperature dependence:	<0.1%/°C
Relay contacts:	2 x changeover, volt-free for general switching operations
Load capacity - AC:	250V @ 8A, 2 kVA
Load capacity - DC:	24V 8A 500 mW min.
Insulation:	4 kV/1 min
Mechanical endurance:	30 x 10 <sup>6</sup> operations
Electrical life (AC1):	7 x 10 <sup>4</sup>
<b>Other Data</b>	
Dimensions:	90 x 17.6 x 64 mm
Weight:	83 g
Maximum conductor size:	2 x 1.5 mm <sup>2</sup> or 1 x 2.5 mm <sup>2</sup>
Operating temperature:	-20 to +55 °C
Storage temperature:	-30 to +70 °C
Over-voltage category:	III
Pollution degree:	2
Environmental protection:	IP40 for front panel, IP20 for terminals.
Standards:	EN 60255-6, EN 60255-27, EN 61000-6-2, EN 61000-6-4

Warning: In case of supply from the main, neutral wire must be connected to terminal A2.

### Connection

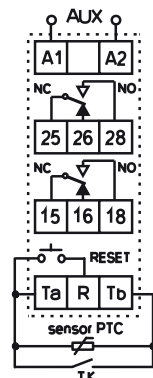

- This unit monitors the temperature of a motor using the PTC sensor (positive temperature coefficient resistor) or thermostat (TK) switch built in to the motor winding. Relay contacts can be used to disconnect the supply to the motor if it overheats. LEDs indicate mains on and fault status.
- Switches on the front panel select sensor type and latching (memory) on/off. In latching mode, the unit must be reset after a trip by means of the front panel Reset button or an external switch.
- These instructions contain important safety information. Please read them thoroughly before commissioning, operating or maintenance of the unit.

### Description

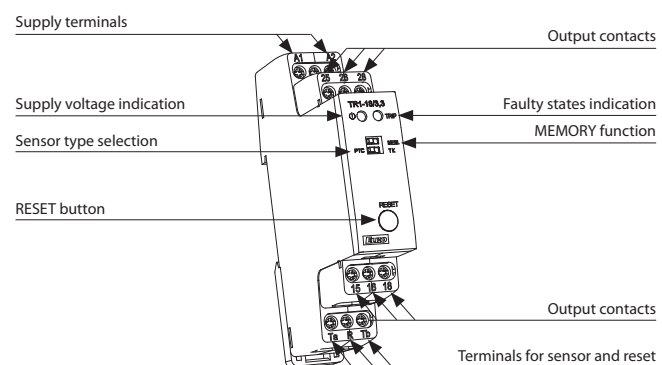

### Function

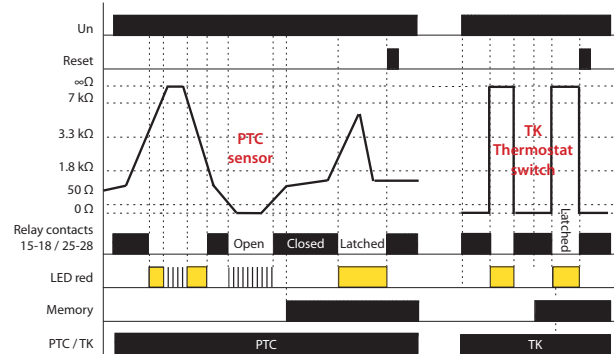

The differential 1.8k/3.3k trip levels prevent relay chatter as the monitored temperature varies.

As the relays have changeover contacts, the relay outputs can be inverted by wiring to the alternative terminals 15-16 or 25-26.

The green LED lights shows when the power supply is on.

With the motor running at its normal temperature, the red LED will be off and relay contacts 15-18 and 25-28 will be closed.

#### PTC mode

Select this mode if the motor is fitted with a PTC sensor.

If the motor overheats and PTC resistance goes above 3.3 kΩ, relay contacts 15-18 and 25-28 open. These contacts can be used to disconnect the supply to the motor.

With the Memory switch set to Off, the red LED lights and the contacts stay open until the motor has cooled and the PTC resistance has fallen to below 1.8 kΩ.

With Memory (latching) On, the red LED lights and the relay contacts stay open until the Reset button is pressed or an external reset switch closes.

The red LED flashes if the PTC sensor fails open- or short-circuit.

#### TK mode

Select this mode if the motor is fitted with a thermostat switch.

If the motor overheats, the thermostat switch opens, the red LED lights and the relay contacts 15-18 and 25-28 open.

With the Memory switch set to Off, the red LED goes off and the relay contacts close when motor cooling causes the thermostat to close again.

With Memory (latching) On, the LED stays on and the relay contacts remain open until the Reset button is pressed or an external reset switch closes.

### Dimensions

#### 1-MODULE DESIGN

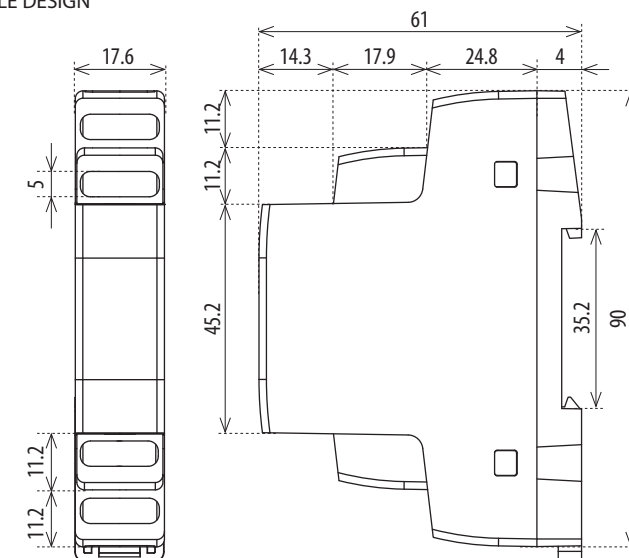

#### 3-MODULE DESIGN

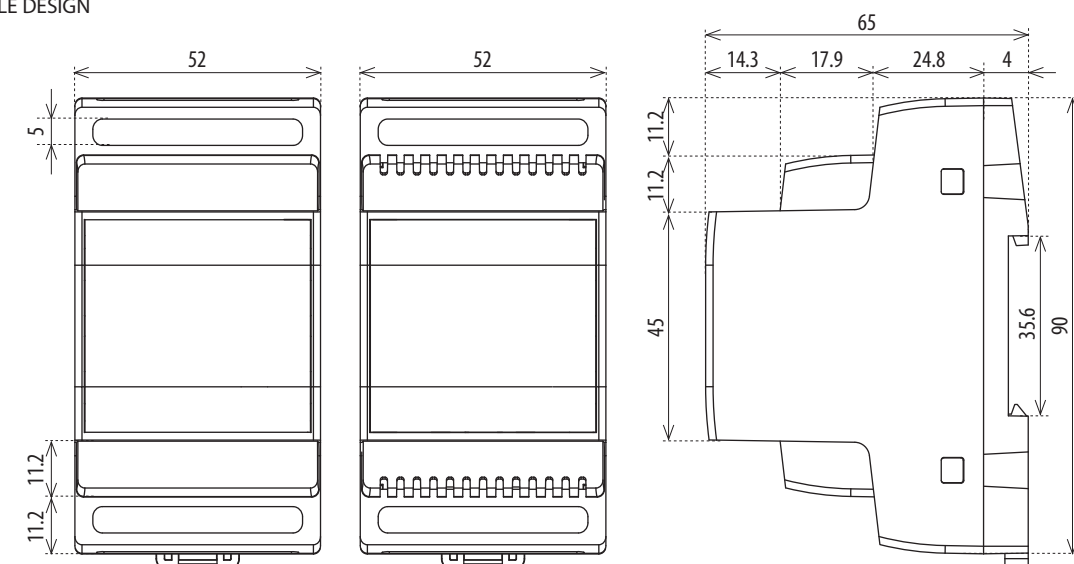

#### 6-MODULE DESIGN

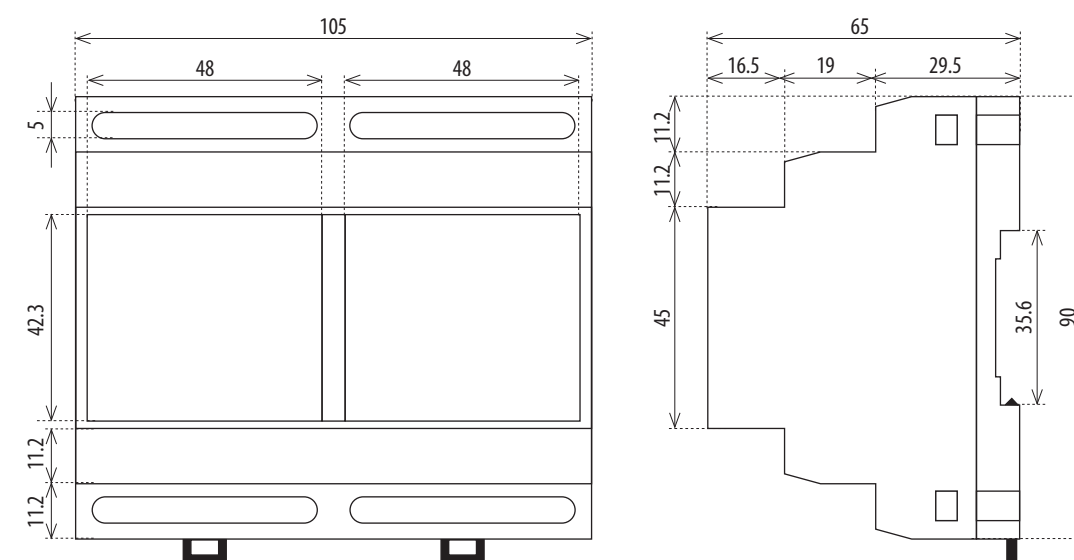



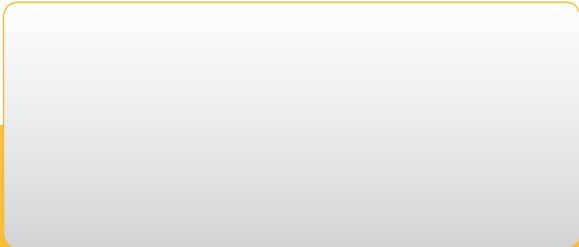
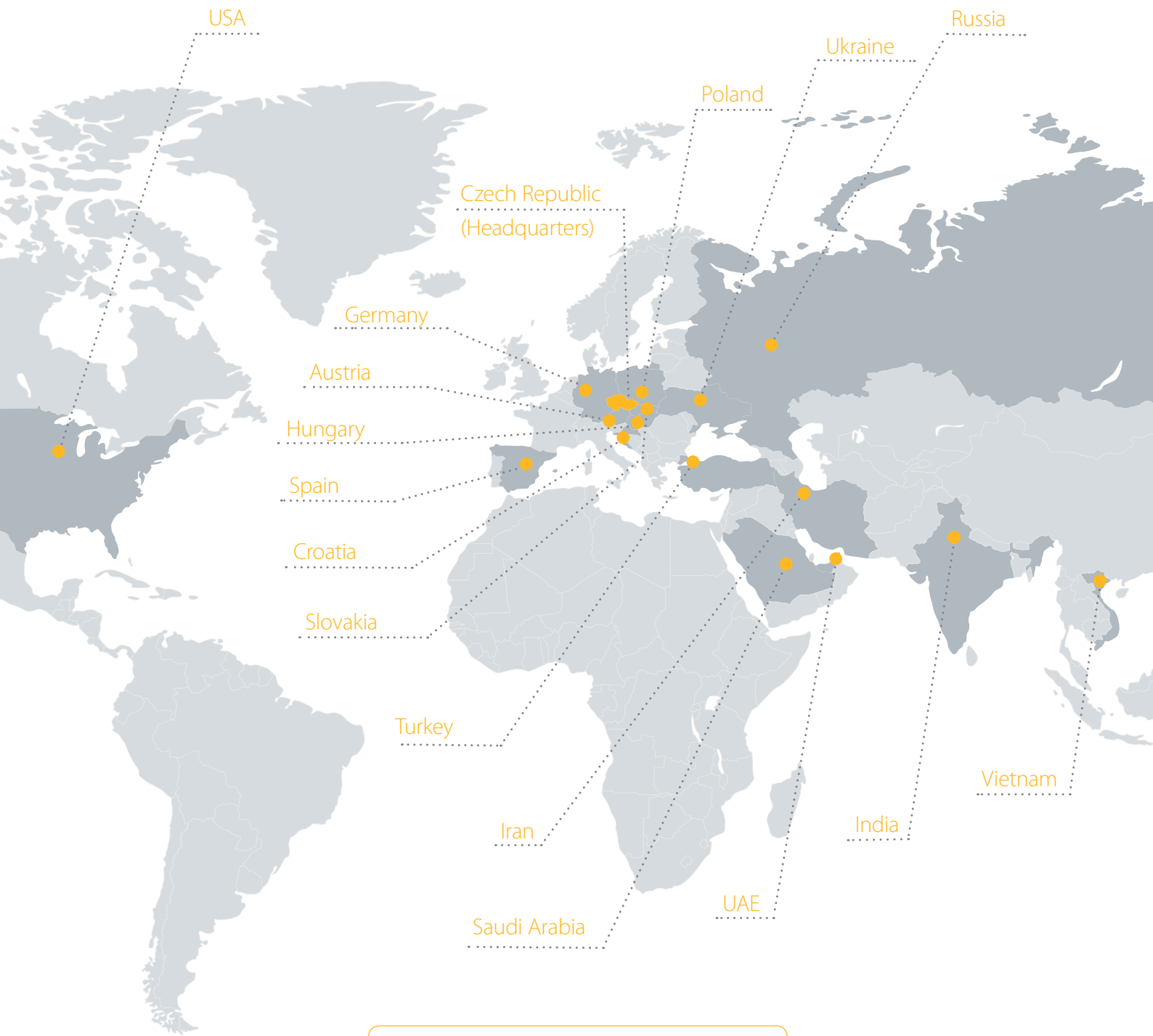

**ELKO EP, s.r.o.**

Palackeho 493 | 769 01 Holesov, Vsetuly | Czech Republic  
phone: +420 573 514 221 | fax: +420 573 514 227 | [elko@elkoep.com](mailto:elko@elkoep.com) | [www.elkoep.com](http://www.elkoep.com)

Published: 01/2018 | Modifications or amendments reserved | © Copyright ELKO EP, s.r.o. | 1st edition