

ELKO EP, s.r.o.
 Palackého 493
 769 01 Holešov, Vsetuly
 Czech Republic
 Tel.: +420 573 514 211
 e-mail: elko@elkoep.com
 www.elkoep.com

Made in Czech Republic

02-1/2025



HRN-100/2

Multifunction voltage monitoring relay
in 3P with LCD display



Characteristics

- 3-wire or 4-wire connection (with or without neutral).
- Optionally monitors upper and lower voltage & frequency in 3-phase circuits.
- Allows monitoring of phase sequence, failure and asymmetry incl. neutral fail (only in 4-wire connection).
- The device is supplied from monitored voltage.
- Both output contacts can be set individually.
- Measures real effective value of AC voltage (True RMS).
- Optional response delay of the output contact to the measured fault state or transition from the fault state to the OK state incl. delayed response of output contacts after connecting the power supply.
- Possibility of automatic or manual transition from fault state (memory).
- Optional closing or opening of the output contact when measuring a fault state (Fail Safe / Non Fail Safe).
- Password protection against unauthorized changes to settings.
- Digital backlit display with the possibility of monitoring the current state of the network, incl. possible failures.
- The last five fault states are stored in a history that can be viewed retrospectively.
- Sealable transparent cover for display and controls.

Description

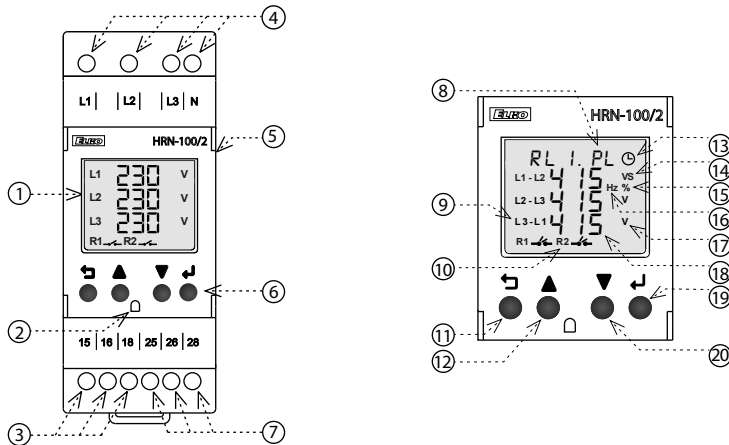

1. Backlit display
2. Place for sealing
3. Output contact RL1 (15-16-18)
4. Supply/monitored voltage terminals (L1-L2-L3-N)
5. Transparent opening cover
6. Control buttons
7. Output contact RL2 (25-26-28)
8. Fault status window and function menu in settings
9. Indication of phase or line voltage
10. Status of output contacts RL1 and RL2

11. ESCAPE button -
12. UP button -
13. Indication of a running delay
14. Delay in seconds
15. Asymmetry in percent
16. Frequency in hertz
17. Voltage in volts
18. Current state of voltage or other configurable parameter
19. ENTER button -
20. DOWN button -

Connection

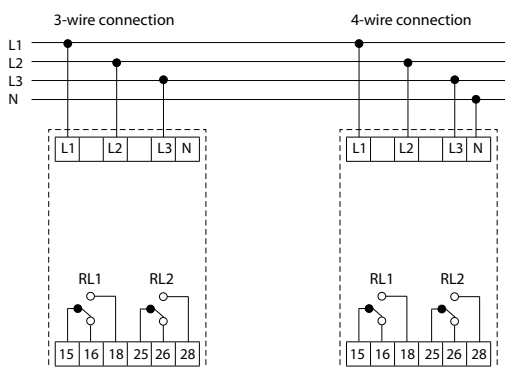

Technical parameters

HRN-100/2

Power supply

Supply and measuring terminals:	L1, L2, L3, (N)
Supply and monitored voltage:	$U_{LN} = 3 \sim 90 - 288 \text{ V}$, (AC 45-65 Hz) $U_{LL} = 3 \sim 155 - 500 \text{ V}$, (AC 45-65 Hz)
Power consumption (max.):	5 VA

Measuring circuit

Selection of the measured circuit:	Phase voltage - 3 phase, 4 wire Line voltage - 3 phase, 3 wire
Adjustable upper (OV) and lower (UV) voltage levels:	Phase voltage: 90 - 288 VAC Line voltage: 155 - 500 VAC
Upper (HC) / lower (LC) limit voltage:	Phase voltage: 310 VAC / 85 VAC Line voltage: 535 VAC / 150 VA
Adjustable upper (OF) and lower (UF) frequency level:	45 - 65 Hz
Adjustable asymmetry:	Absolute: 5 - 99 VAC Percentage: 2 - 50%
Adjustable voltage and frequency hysteresis level:	3 - 20 VAC (OV,UV, HC, LC) 0.5 - 2 Hz (OF, UF)
Adjustable hysteresis asymmetry:	Absolute: 3 - 99 VAC Percentage: 2 - 15%
Accuracy of measured voltage:	+/- 5V
Accuracy of measured frequency:	+/- 0.3 Hz
Adjustable delay after supply connection P_{on} :	0 - 999 s (HW initialization 250 ms)
Adjustable delay T_{on} :	0.5 - 999 s
Adjustable delay T_{off} :	0.1 - 999 s
Fixed delay:	<100 ms (phase sequence, failure) <200 ms (HC, LC), <500 ms (neutral fail)

Output

Output contact:	2x changeover (AgSnO ₂)
Rated current:	5A / AC1
Switching power:	1200VA / AC1, 150W / DC1
Switching voltage:	240V AC / 30V DC
Max. output power dissipation:	5W
Mechanical life:	10.000.000 operations
Electrical life (AC1):	100.000 operations

Other information

Operating temperature:	-10°C to +60 °C (14 °F to 140 °F)
Storage temperature:	-20 to +70 °C (-4 °F to 158 °F)
Dielectric strength:	4kV (supply - output)
Operating position:	any
Mounting:	DIN rail EN 60715
Protection degree:	IP20 cover and terminals / IP40 front panel with cover
Overvoltage category:	III.
Degree of pollution:	2
Cable size (mm ²):	max. 1x 2.5, max. 2x 1.5 / with sleeve max. 1x 2.5 (AWG 24-12)
Dimensions:	90 x 36 x 66,5 mm
Weight:	132 g
Standards:	EN 61812-1, EN IEC 63044

Function

Overvoltage - undervoltage

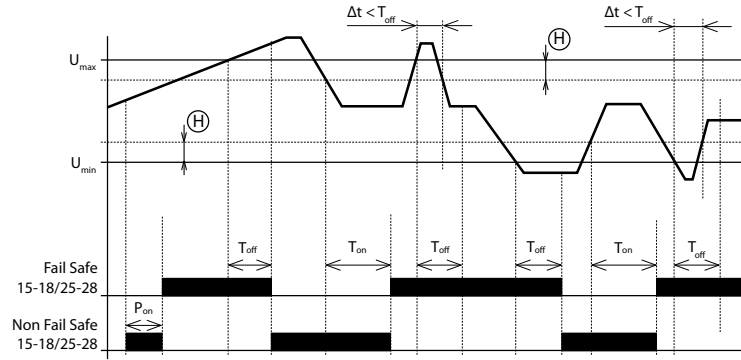

- After the supply/monitored voltage is connected, the delay P_{on} starts timing - during the timing the output contact is in a fault state - in the FAIL SAFE mode it is open. After the delay, if the monitored voltage is in the range $U_{min} \dots U_{max}$, the output contact closes.
- If the monitored voltage exceeds the set value U_{max} , the time delay to the fault state (T_{off}) starts. After the delay, the output contact opens.
- If the monitored voltage falls below the U_{max} value reduced by the set hysteresis, the time delay start to OK state (T_{on}). After the delay, the output contact closes.
- If the duration of the fault state (Δt) is shorter than the set value T_{off} , the status of the output contact does not change.
- If the monitored voltage falls below the value U_{min} , the time delay to the fault state (T_{off}) starts. After the delay, the output contact opens.
- If the monitored voltage exceeds the value U_{min} increased by the set hysteresis, the time delay start to OK state (T_{on}). After the delay, the output contact closes.
- If the duration of the fault state (Δt) is shorter than the set value (T_{off}), the status of the output contact does not change.

Phase sequence

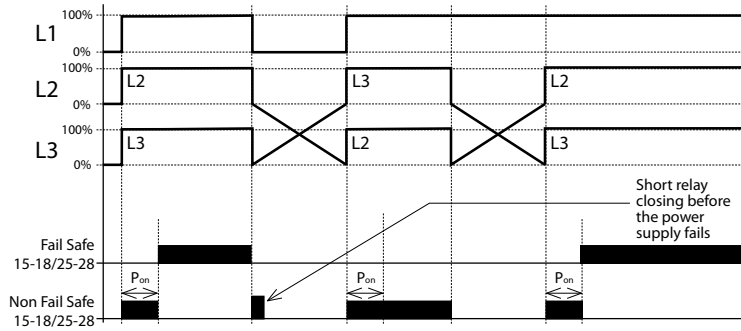

- After the supply/monitored voltage is connected, the delay P_{on} starts timing - during the timing the output contact is in a fault state - in FAIL SAFE mode it is open. After the delay, if the phase sequence is correct, the output contact closes.
- If the phase sequence is incorrect after the P_{on} delay, the output contact remains open (fault state)

Asymmetry, phase failure

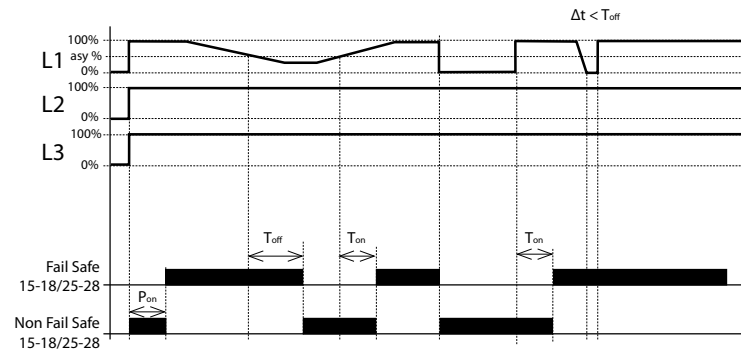

- After the supply/monitored voltage is connected, the delay P_{on} starts timing - during the timing the output contact is in a fault state - in the FAIL SAFE mode it is open. After the delay, if the phase asymmetry is lower than the set value (absolute or percentage - see technical parameters), the output contact closes.
- If the phase asymmetry exceeds the set value, the time delay to the fault state (T_{off}) begins. After the delay, the output contact opens.
- If the phase asymmetry falls below the set value, the time delay starts to OK state (T_{on}). After the delay, the output contact closes.
- If the duration of the fault state (Δt) is shorter than the set value T_{off} , the status of the output contact does not change.
- If a phase failure occurs, the time delay to the fault state (T_{off}) begins. After the delay, the output contact opens.
- If the phase failure resumes, the time delay starts to OK state (T_{on}). After the delay, the output contact closes.
- If the duration of the fault state (Δt) is shorter than the set value T_{off} , the status of the output contact does not change.

Graph legend:

P_{on} - Power ON delay (delay after power supply connection)
 T_{on} - ON delay (delay to OK state)
 T_{off} - OFF delay (delay to fault state)

T_{off} - 0,1 - 999 s
 T_{off} - Adjustable for OV, UV, OF, UF & asymmetry faults
 T_{off} - Phase sequence, failure <100ms; Neutral fail <500ms
 Δt - Duration of the fault state
 (H) - Hysteresis

Description of controls and signalling

Output contact mode

Mode	OK state	Fault state
Fail Safe	15 & 25 (Pole) 18 & 28 (NO)	15 & 25 (Pole) 18 & 28 (NO)
Non Fail Safe	15 & 25 (Pole) 18 & 28 (NO)	15 & 25 (Pole) 18 & 28 (NO)

Fault status window

Short-cut	Meaning
"FLT.NF"	Neutral fail
"FLT.LC"	Lower threshold voltage
"FLT.HC"	Upper threshold voltage
"RLx.PL"	Phase failure
"RLx.PR"	Phase sequence
"RLx.ASY"	Phase asymmetry
"RLx.OF"	Overfrequency
"RLx.UF"	Underfrequency
"RLx.OV"	Overvoltage
"RLx.UV"	Undervoltage

Note: RLx indicates RL1 & RL2

Control buttons

ESCAPE	Enter the settings menu (long press >1s). Return to the main screen or previous menu in edit or display mode. Step back when changing a value or parameter.
UP	Move parameters up. Change/increase the value of a parameter in edit mode. Selection of the currently measured parameter on the main screen - voltage, frequency, asymmetry (pressing the button <500ms).
DOWN	Moving parameters down. Change/decrease the value of a parameter in edit mode. Display history of fault states (pressing the button <500ms).
ENTER	Select and save a parameter value in edit mode. Resetting the product from memory mode (long press >1s).
ESCAPE ENTER	Press a key combination to display the read-only settings menu (long press >1s).

Control

Programming menu structure

- to enter the programming menu, press and hold the ESCAPE button for >1s (⏏)
- possibility of changing a parameter / value is signalled by its flashing on the display

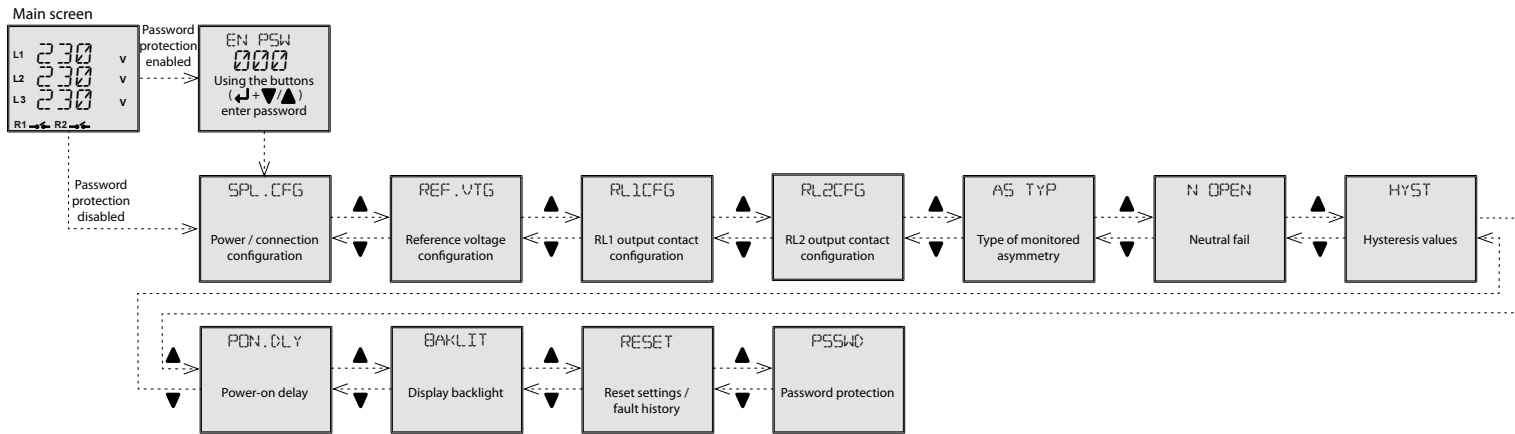

Individual settings of items in the submenu

• Power / connection configuration

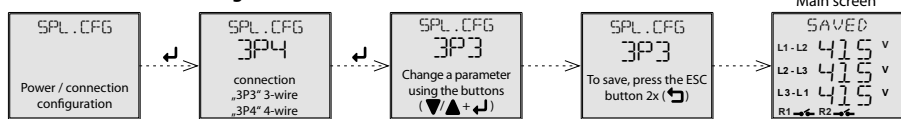

• Reference voltage configuration

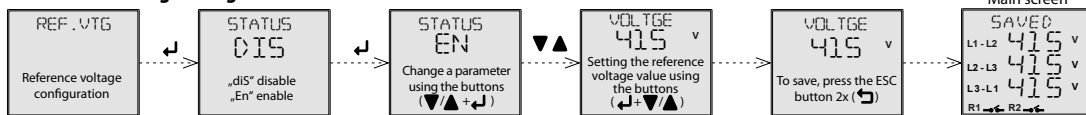

• Type of monitored asymmetry



• Neutral fail

only displayed when power / connection configuration (3P4)

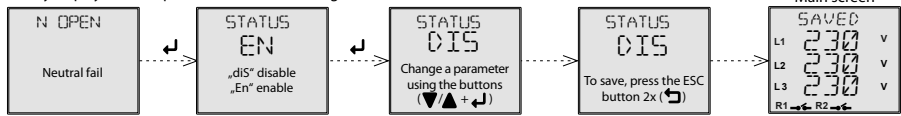

• Hysteresis values

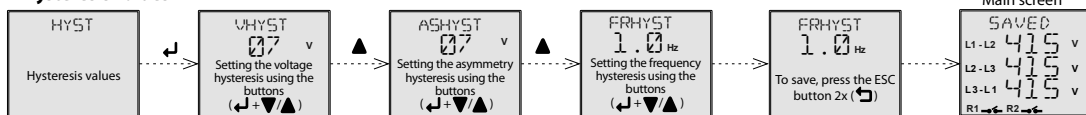

• Power-on delay

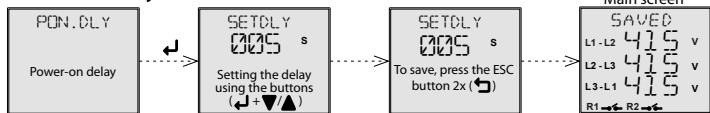

• Display backlight



• Reset settings / fault history

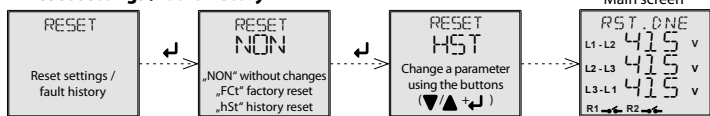

• Password protection

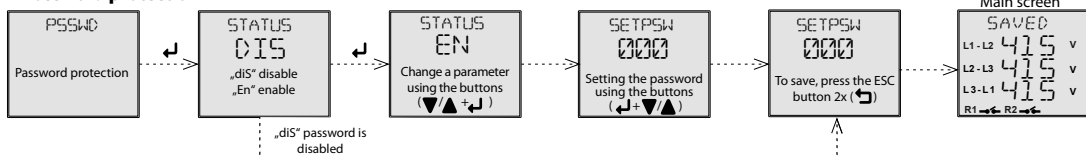

• RL1 configuration

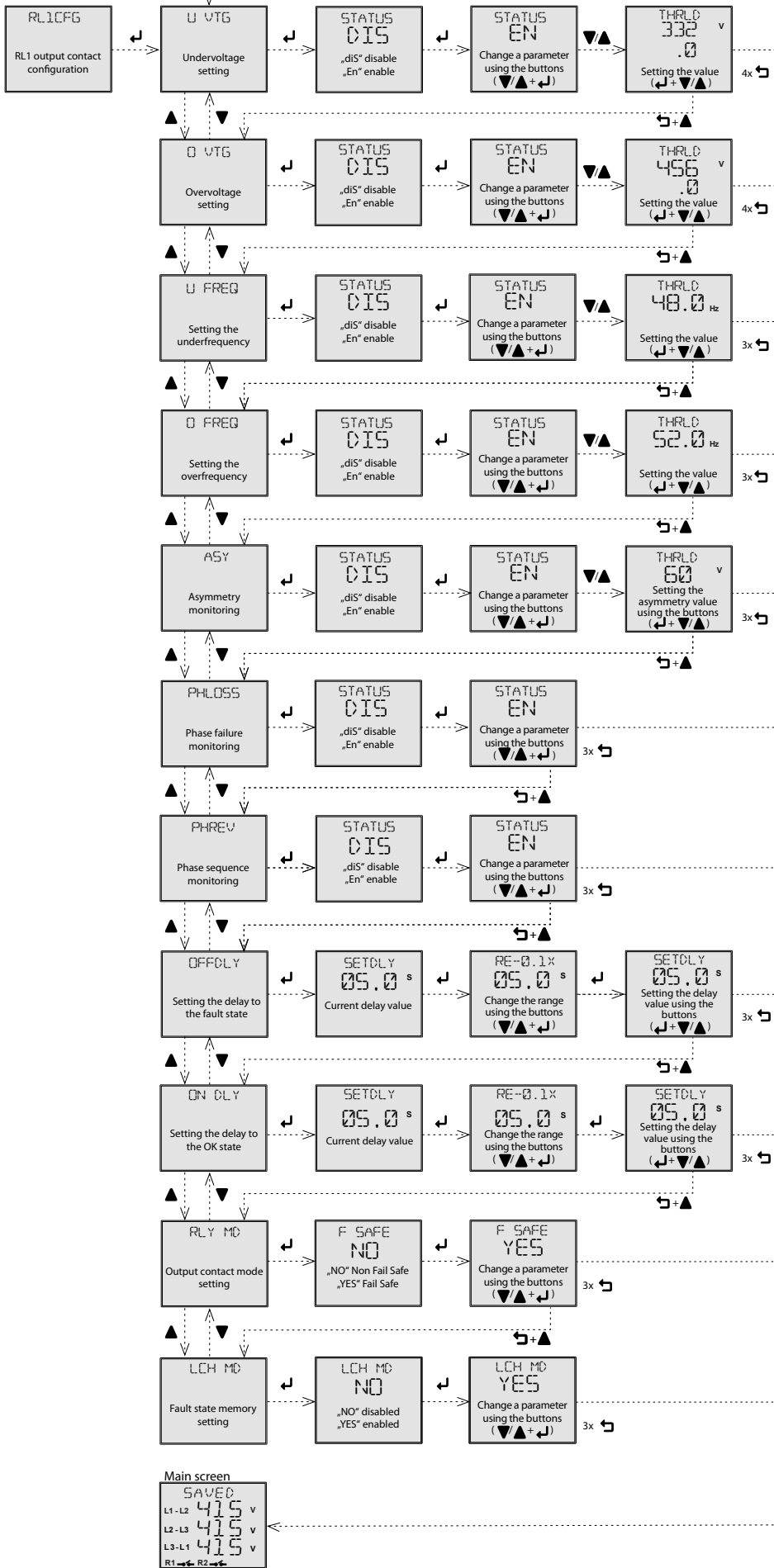

• RL2 configuration

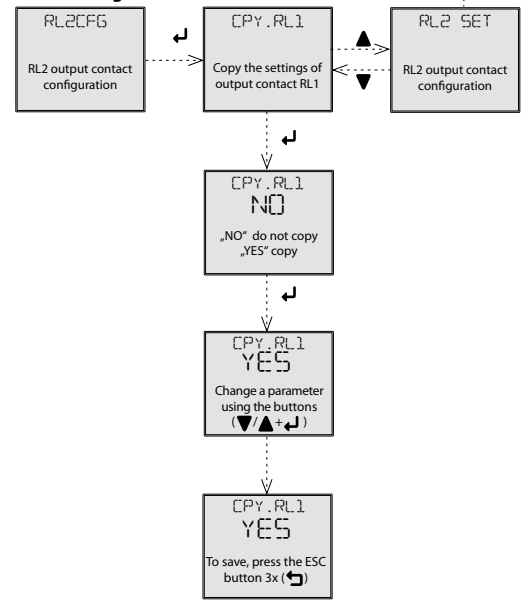

Warning

Device is constructed for connection in 3-phase main and must be installed according to norms valid in the state of application. Connection according to the details in this direction. Installation, connection, setting and servicing should be installed by qualified electrician staff only, who has learnt these instruction and functions of the device. This device contains protection against overvoltage peaks and disturbances in supply. For correct function of the protection of this device there must be suitable protections of higher degree (A, B, C) installed in front of them. According to standards elimination of disturbances must be ensured. Before installation the main switch must be in position "OFF" and the device should be deenergized. Don't install the device to sources of excessive electro-magnetic interference. By correct installation ensure ideal air circulation so in case of permanent operation and higher ambient temperature the maximal operating temperature of the device is not exceeded. For installation and setting use screw-driver cca 2 mm. The device is fully-electronic - installation should be carried out according to this fact. Non-problematic function depends also on the way of transportation, storing and handling. In case of any signs of destruction, deformation, non-function or missing part, don't install and claim at your seller it is possible to dismount the device after its lifetime, recycle, or store in protective dump.